

EFFER

685-955-1405

Progress 3.0 CE

Operator's Manual GB

This operator's manual is an Original Instruction valid for crane models EFFER 685-955-1405 with Progress 3.0 from serial number(s):

ME0068500001 - ME0095500001 - ME0140500001

Congratulations!

You are now the owner of a quality Product manufactured by Hiab (part of Cargotec Corporation).

The aim of this manual is to help you handle, maintain your crane safely and with full satisfaction.

This Manual provides detailed information about your Product, its control systems and its practical management and maintenance.

Please read the complete Manual carefully and make sure that you understand its contents. Please also carefully familiarise yourself with your Product before you start to use it.



Help us to improve this manual. Please send your comments and suggestions to **documentation@hiab.com**

Table of Contents

1. Introduction	7
1.1. Target group and scope of this manual	7
1.2. The Machinery Directive 2006/42/EC	8
1.3. The Machinery (Safety) Regulations 2008	9
1.4. Indications in the Operator's Manual	9
2. Structure and parts of the crane	12
2.1. Main groups	12
2.2. Crane base with column and slewing system	13
2.3. Stabiliser system	14
2.4. Boom system	14
2.5. Operating system - hydraulic components	17
2.6. LHV Load holding valves	18
2.7. Description of the crane	18
2.8. Available configurations	19
3. Safety precautions and warnings	23
3.1. Operating conditions	23
3.2. Wind conditions	24
3.2.1. Wind speed	24
3.2.2. Load shape	24
3.2.3. Working height (H)	26
3.2.4. TABLE A: Beaufort scale	26
3.2.5. TABLE B - Conversion wind speed	28
3.3. Definition of this loader crane	28
3.3.1. Noise declaration	29
3.3.2. Signs on the crane	30
3.3.3. Maximum load	30
3.3.4. Maximum load moment	33
3.4. Signals when using a crane	35
3.5. Use of the crane	39
3.5.1. Preparations for use	40
3.5.2. Crane operation	42
3.5.3. Driving with the crane	45
3.5.4. Use of lifting accessories and interchangeable equipment	46
3.5.5. Use of demountable cranes	47
3.5.6. Ending crane operation	47
4. The control system	48
4.1. Control System Progress 3.0	48
4.2. How the control system works	48
4.3. Components of Progress 3.0	49
4.4. Standard symbols and functions of the crane	49
4.5. Main control valve	51
4.6. Different stabiliser control valves	51
4.7. User Interface with LEDs [option]	51
4.7.1. Indicator LEDs on the User Interface	52
4.8. User interface with the display panel [option]	53
4.8.1. Display panel	53
4.9. Lamps on the stabiliser legs [option]	57

4.10. Warning lamp on the column	57
4.11. SCANRECO controller	58
4.11.1. Buttons, selectors and LEDs	59
4.11.2. Displays	61
4.11.3. Standard functions and symbols	63
4.11.4. Battery and battery charger	69
4.12. SCANRECO HD controller	70
4.12.1. Buttons, selectors and LEDs	71
4.12.2. Displays	73
4.12.3. Standard functions and symbols	76
4.12.4. Battery and battery charger	80
4.13. High seat [option]	81
5. Starting crane operation	82
5.1. Starting operations	82
5.2. Set the stabiliser system	85
5.2.1. Stabiliser system and ground conditions	86
5.2.2. Activate the stabiliser system	88
5.2.3. Extend the stabiliser extensions	90
5.2.4. Set the stabiliser legs	93
5.3. Operate the boom system out of transport position	96
5.3.1. Boom deployment assistance with Progress	96
5.3.2. Operate the boom system	97
6. During operation	98
6.1. Features	98
6.1.1. MAX boom elevation (tipping)	98
6.1.2. MAX speed limitation (automatic slow-down)	99
6.1.3. Snail feature	101
6.1.4. HSS High Speed System [option]	101
6.1.5. Controlling the crane speed with the controller SCANRECO - SCANRECO HD	101
6.1.6. Pump flow sharing	103
6.1.7. Automatic oil temperature detection	103
6.1.8. Radio hook [option]	103
6.1.9. VS Virtual Shield [option]	104
6.1.10. OVS Operator Virtual Shield [option]	104
6.1.11. Integration of a removable ballast and/or counterweight	104
6.1.12. FPI Flow Power Increase	105
6.1.13. Stand-by feature	105
6.1.14. Progress - Stability control device	105
6.1.15. SENSE [option]	108
6.1.16. DLC-S Dynamic Load Chart [option]	110
6.2. Overload protection (Load limiter device)	113
6.2.1. Crane overload protection	113
6.2.2. Release the overload protection	116
6.3. Truck stability conditions	117
6.4. Manual extensions [if installed]	117
6.5. The 9 th extension [option]	120
6.6. Hydraulic connections	121
6.6.1. Hydraulic couplings [option]	121
6.6.2. Multi-connection hydraulic quick couplings (quickfaster) [option]	122

6.7. Electrical connections [option]	123
7. Ending crane operation	124
7.1. Operate the boom system into transport position	124
7.1.1. Operate the boom system	124
7.2. Operating the stabiliser system into the transport position	125
7.3. Switching off the control system	131
7.4. Emergency operation	131
7.4.1. Display messages and password	131
7.4.2. Bypass Progress (crane - stabilisers) procedure	132
7.4.3. Crane movements in an emergency	138
7.4.4. Stabiliser system movements in an emergency	139
7.5. Transport warning	142
8. Maintenance and Service	143
8.1. Service	143
8.2. Warranty	144
8.3. Follow the maintenance instructions!	144
8.3.1. Daily inspection	146
8.3.2. Monthly inspection and maintenance	150
8.3.3. First check	151
8.3.4. Annual maintenance	151
8.4. Lubrication	152
8.4.1. General greasing of the cranes	152
8.4.2. Lubrication schedule	154
8.4.3. Central greasing system [option]	154
8.4.4. Lubrication of the slewing bearing and the bearing assembly	155
8.4.5. Lubrication of the boom system	155
8.4.6. Grease on the stabiliser extensions	156
8.4.7. Lubrication of the hooks	156
8.5. Checking and topping up oil levels	157
8.5.1. Slewing motors gearbox	157
8.5.2. Oil tank / Hydraulic oil	158
8.5.3. Bleeding air from the hydraulic system	160
8.6. Replacement of filters	161
8.6.1. High pressure filter	161
8.6.2. Return oil filter with clogging indicator	162
8.6.3. Breathing filter	162
9. Decommissioning	163
9.1. Decommissioning a crane	163
10. Technical Data	165
10.1. Load plate table and stability diagrams	165
10.2. Identification of the loader crane	166
10.3. Daily inspection checklist	167
10.4. Monthly inspection checklist	168

This page is intentionally left blank.

1. Introduction

1.1. Target group and scope of this manual

This manual describes:

- Operation
- Safety precautions and warnings
- The crane control system
- Maintenance and troubleshooting

Enclosed to this manual the Installer will provide:

- Technical Data for your crane
- Technical Data and manuals for interchangeable equipment if fitted

Study these instructions carefully



DANGER

If you do not study the complete Operator's Manual for your crane carefully, it could lead to fatal accidents or serious damage.



NOTE

This manual gives instructions for a crane installed on commercial vehicles.

Therefore you should:

- Study the entire Operator's Manual carefully.
- Study the operating manuals for other interchangeable equipment and/or optional crane component, if fitted.
- Use the crane only after having done so.
- Follow the directions for use, operation and maintenance of the crane, interchangeable equipment and/or optional crane component exactly.
- Store the Technical Data and manuals from the Installer, together with this Operator's manual.





NOTE

Hiab, or a third party designated by Hiab, shall at all times have the right to (i) install, maintain and dismantle a remote diagnostics device in and from the Products; and (ii) access, send, receive, collect, store, copy, aggregate, combine with other information, process, make available, further develop and use any and all information and data gathered through the remote diagnostics device, including but not limited to, information concerning equipment identity, efficiency, availability, downtime, operation, operating environment, movement, condition, logon, location and similar information relating to the Products (the "Information"). Such Information may be used for providing, delivering, optimizing, developing, servicing and offering the Products or any related products, equipment, and services. The Information may also be used for example for sales and marketing, Hiab's internal business and/or operating purposes as well as for regulatory, warranty and contract compliance and for proactive maintenance and diagnostics. The Information may be shared to Hiab's group companies and to Hiab's and its group companies' dealers, subcontractors, service providers and other business partners for the above described purposes.

The Customer shall not in any way remove, disable, or interfere with the remote diagnostics device or the Information without Hiab's prior written consent. Any intellectual property rights or other right and title in and to the remote diagnostics device and its features and the Information and all their further developments shall at all times be and remain the exclusive property of Hiab.

1.2. The Machinery Directive 2006/42/EC

- The Declaration of Conformity, delivered with the crane contains (1):
- Business name and full address where the crane is manufactured (2):
 Factory addresses:
 Hiab Cranes S.L.U. Pol. Ind. Malpica, calle E, 86 50016 Zaragoza, Spain
 Cargotec Poland Sp. z o. o. Ul. Metalowa 2, 73-102 Stargard, Poland
 Hiab Italia S.r.l. Via IV Novembre 12, 40061 Minerbio (BO), Italy
- Description and identification of the loader crane (3):
 Mark
 Type: see chapter Identification of the crane.
 Serial number
 Manufact. year
 Declaration of which provisions the loader crane fulfils.

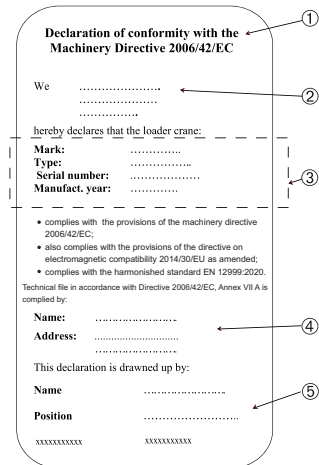

Declaration of conformity with the Machinery Directive 2006/42/EC

We

hereby declares that the loader crane:
 Mark:
 Type:
 Serial number:
 Manufact. year:

• complies with the provisions of the machinery directive 2006/42/EC;
 • also complies with the provisions of the directive on electromagnetic compatibility 2014/30/EU as amended;
 • complies with the harmonised standard EN 12999:2020.

Technical file in accordance with Directive 2006/42/EC, Annex VII A is compiled by:
 Name:
 Address:

This declaration is drawn up by:
 Name
 Position

XXXXXXXXXX XXXXXXXXXXXX

- Name and address of the person authorised to compile the technical file (4):
Name
Address
- Identity and signature of the person who drawn up the declaration (5):
Name
Position
Date and Signature



1.3. The Machinery (Safety) Regulations 2008

- The Declaration of Conformity, delivered with the crane contains (1):
- Business name and full address where the crane is manufactured (2):
Factory addresses:
Hiab Cranes S.L.U. Pol. Ind. Malpica, calle E, 86 50016 Zaragoza, Spain
Cargotec Poland Sp. z o. o. Ul. Metalowa 2, 73-102 Stargard, Poland
Hiab Italia S.r.l. Via IV Novembre 12, 40061 Minerbio (BO), Italy
- Description and identification of the loader crane (3):
Mark
Type: see chapter Identification of the crane.
Serial number
Manufact. year
Declaration of which provisions the loader crane fulfils.
- Name and address of the person authorised to compile the technical file (4):
Name
Address
- Identity and signature of the person who drawn up the declaration (5):
Name
Position
Date and Signature

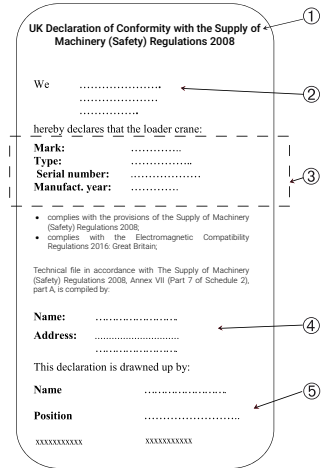

UK Declaration of Conformity with the Supply of Machinery (Safety) Regulations 2008

We ②

hereby declares that the loader crane:

Mark: ③
Type:
Serial number:
Manufact. year:

• complies with the provisions of the Supply of Machinery (Safety) Regulations 2008.
• complies with the Electromagnetic Compatibility Regulations 2016 Great Britain.

Technical file in accordance with The Supply of Machinery (Safety) Regulations 2008, Annex VII (Part 7 of Schedule 2), part A, is compiled by:

Name: ④
Address:

This declaration is drawn up by:

Name ⑤
Position
XXXXXXXXXX XXXXXXXXXXXX



1.4. Indications in the Operator's Manual

What must you do and not do?

The following indications are used in the Operator's Manual:



DANGER

Danger to life for yourself or to bystanders.
Follow the instructions carefully!

**WARNING**

Danger of injury to yourself or to bystanders, or danger of serious damage to the crane or other objects.

Follow the instructions carefully.

**CAUTION**

Hazard for the crane or crane components. Follow the instructions carefully.

Important:

If actions are numbered, do them in numerical order!

1. Do this
2. Do that
3.

**NOTE**

Extra information that can prevent problems.

**TIP**

Tip to make the work easier to carry out.

The symbol for reference to a component in an illustration.

(1) Refers to a component in an illustration.

[option]: Indication for parts that are not standard for the crane, but are optional. Not all options are available for your crane.

Illustrations used in this manual are for guidance only, and the illustrations are provided to help identify the general area of a crane/installation referenced in the text.

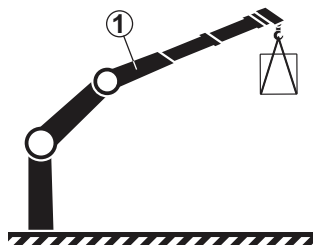
**DANGER**

Only persons with the requisite knowledge and experience with cranes may use the crane. Never operate the crane when you are sick, tired, under the influence of medicines, alcohol, or other drugs.

- Take the delivery instructions from your authorised service workshop, or receive instruction from an experienced person from your own company before you start to operate your crane.

- Make sure that you comply with the regulations of the country in which you use the crane (for example, certificate, safety helmet, and other personal protection devices).



DANGER

- Carry out yourself only the service and maintenance work you have the requisite knowledge and experience of.
- All other maintenance work may only be carried out by an authorised service workshop.
- Make sure that every defect is rectified immediately, according to the instructions.
- Follow the instructions exactly!
- Do not adjust/replace safety hydraulic/electrical components on the crane, as you can cause dangerous accidents. Only an authorised service workshop can do these actions.
- All other work to rectify faults must be performed by personnel in an authorised service workshop!

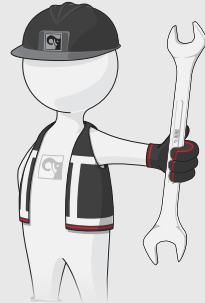

WARNING

- Never clean the electronic system, plastic components, signs, or bearings with a high-pressure jet cleaner. It could cause damage.
- Never expose the electronic system to high electrical voltages. This could damage the control system.
- Never immerse the controller in water or other liquid. This will make the controller unusable.

If your crane is equipped with interchangeable equipment and/or optional crane components (JIB, hoist, rotator, etc.):

- The operation of the crane with interchangeable equipment and/or optional crane components can differ from the operation as described in this manual.
- You should therefore study the Operating Manual for the interchangeable equipment and/or optional crane components carefully before you use the crane.
- Take particular note when placing the crane into or out of the transport position.

2. Structure and parts of the crane

2.1. Main groups

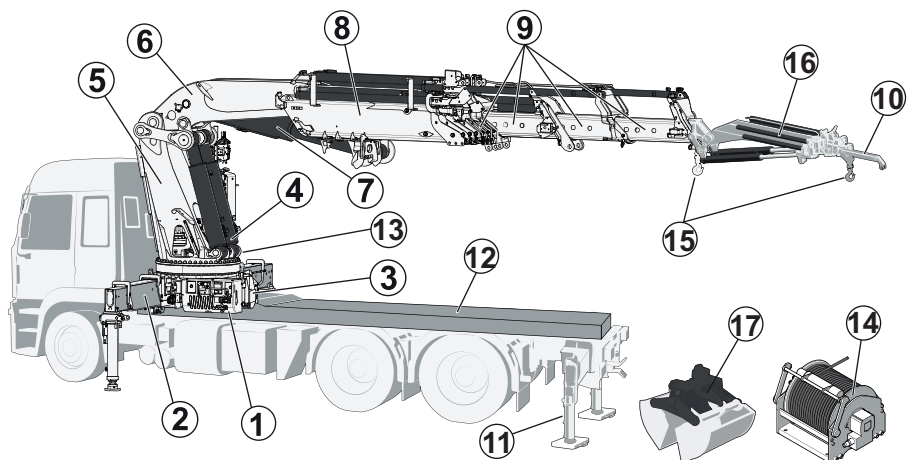

This crane consists of the following main groups:

- | | | |
|-------------------------------|--------------------------------|--|
| (1) Control station | (6) 1st boom | (11) Auxiliary stabilisers (incl. front) |
| (2) Stabiliser system | (7) 2nd boom cylinder | (12) Subframe |
| (3) Base / Three-point bridge | (8) 2nd boom | (13) Oil tank |
| (4) 1st boom cylinder | (9) Boom extensions | (14) Hoist [option] |
| (5) Column | (10) Manual extension [option] | 9 th extension [option] |

Interchangeable equipment (e.g. grapple, clamshell bucket, pallet clamp, etc.), intended to be used on loader cranes can be attached depending on your crane configuration. Please refer to the operator's manual for the equipment.

Some examples:

- (15) Hook [option]
- (16) JIB [option]
- (17) Interchangeable equipment [option]

2.2. Crane base with column and slewing system

The crane base, column, and slewing system consist of the following components:

Crane base (1) with one of the following:

- a stabiliser beam (2)
- stabiliser beam + a subframe incorporated to the base [option]
- a subframe incorporated to the base and the V-Stab (2') stabiliser system [option]
- a subframe incorporated to the base and the CroSStab (2'') stabiliser system [option]

Column (3) fitted to the crane base.

Continuous slewing system (4) composed of a slewing bearing and 1 or 2 hydraulic slewing motors.

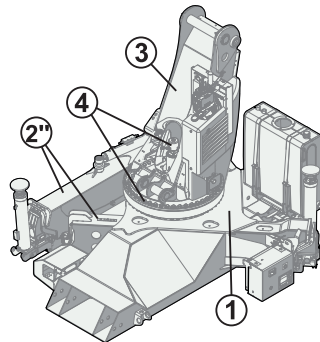
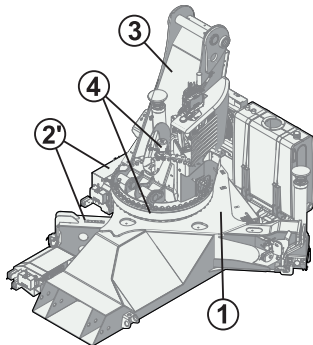
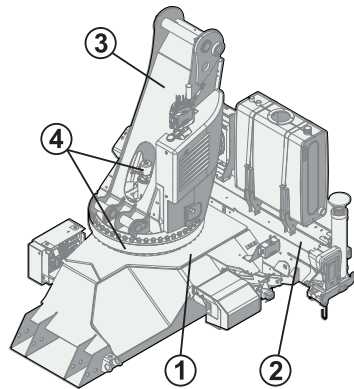
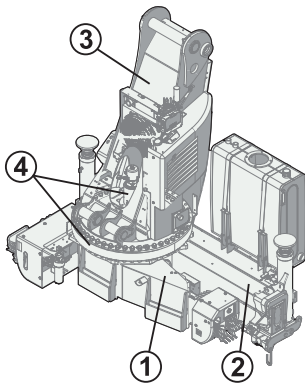

2.3. Stabiliser system

EFFER cranes (except stationary mounted) have two stabiliser extensions and two stabiliser legs. Auxiliary stabiliser systems may be needed. The stabiliser system consists of:

- (1) Stabiliser beam
- (2) Stabiliser extensions
- (3) Stabiliser legs
- (4) Stabiliser locking devices
- (5) Extra support plates

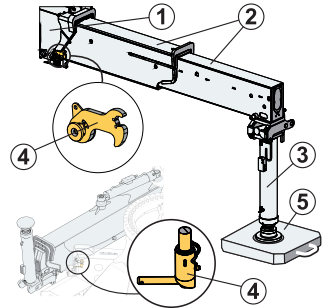

2.4. Boom system

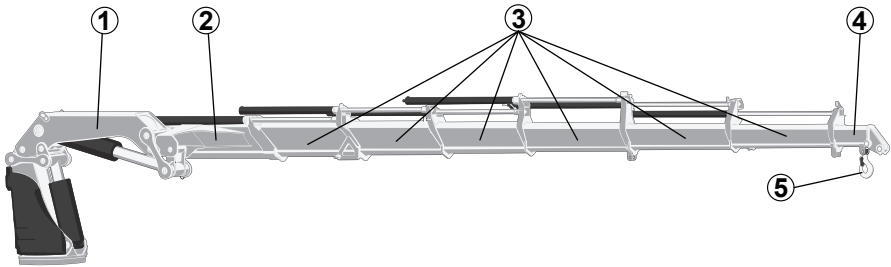

The boom system consists of the following main parts:

- (1) 1st boom
- (2) 2nd boom
- (3) Hydraulic extensions:
The length of the hydraulic extension depends on the type of crane.
- (4) Manual extensions [option]

And optional interchangeable equipment such as:

- (5) Hook [option]
- Pallet fork, Grapple, Rotator, etc... [option]

Manual extensions [option]

The manual extension is slid by hand into the hydraulic extension.

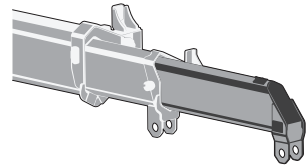

The 9th extension [option]

If installed, and depending on the crane model, the 9th extension extends automatically after the 8th extension or it is activated by a button on the controller.

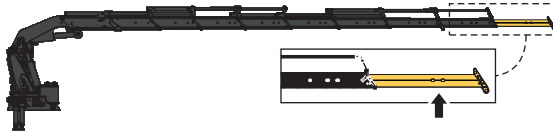

Hoist [option]

The hoist is an optional crane component which permits load handling without any or only limited boom movement. An obvious advantage is that the hoist makes it possible to handle loads far below ground level.

Lifting and lowering is achieved by winding/unwinding the rope. A number of auxiliary components are needed, such as intermediate pulleys and a hook pulley. As an option, a snatch block can be installed to multiply the lifting capacity.

The hoist consists of the following components:

- (1) Pressure roller
- (2) Switch (for rope-end-monitoring)
- (3) Rope
- (4) Load sensor
- (5) Electronic box
- (6) Motor
- (7) Hydraulic valve

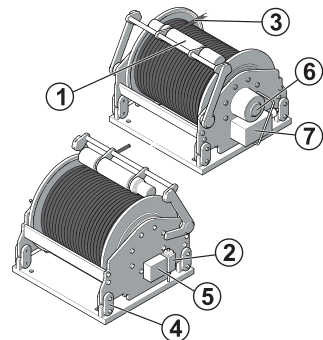

JIB [option]

The JIB is an additional, folding, lifting device that extends the crane boom. Use the JIB to be able to reach further.

The JIB consists of the following components:

- (1) JIB boom
- (2) JIB cylinder
- (3) JIB extension
- (4) JIB extension cylinder
- (5) JIB manual extension [option]
- (6) JIB support / JIB long support [option]

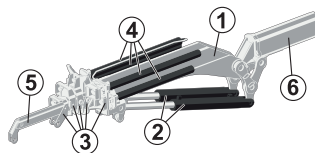

Reversible raised hook extension [option]

Short extension that allows to raise/lower the attachment point of the hook.

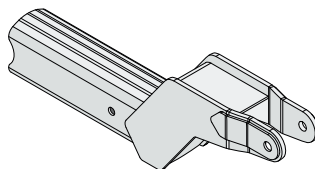

Hooks [option]

Different hooks can be mounted depending on the crane model.



DANGER

Never exceed the maximum permissible loading of the hook.

Lifting accessories [option]

Equipment placed between the holding device of lifting machinery and the load is considered as a lifting accessory.



2.5. Operating system - hydraulic components

The operating system consists of the following hydraulic components:

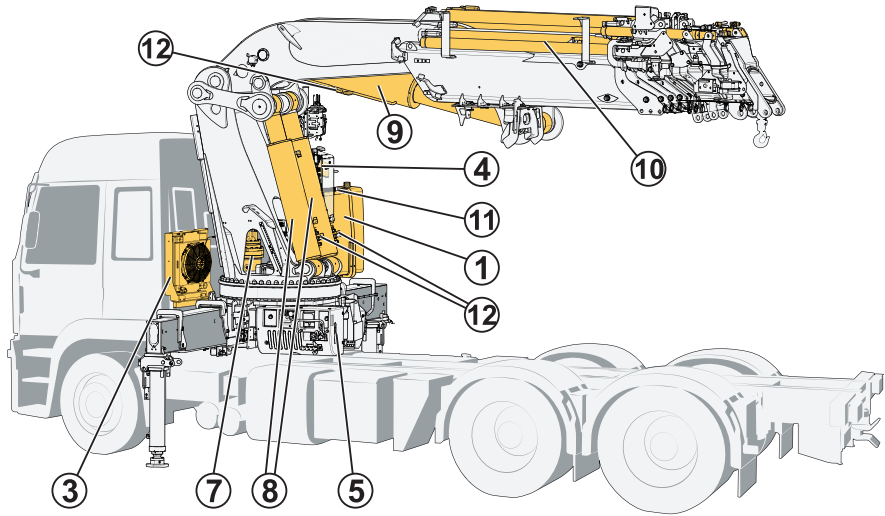

(1) Oil tank	(5) Stabiliser control valve	(11) Return filter
Hydraulic pump	Hydraulic hoses and lines	(12) Load holding valve
(3) Oil cooler	(7) Slewing cylinders / Slewing motors	Pressure filter
(4) Main control valve	Actuators: (8) 1st boom cylinder (9) 2nd boom cylinder (10) Extension cylinder/s	

2.6. LHV Load holding valves

All cylinders are equipped with load-holding valves as a safety device. After a crane movement, they hold the crane in position, also in the unlikely event of a burst hose.

If there is a leak or a component fractures, such as a pipe, hose or coupling, the load-holding valves will stop the booms from collapsing down, even when the hydraulic system is switched off, and you operate a particular crane lever.

To operate a hydraulic cylinder equipped with a load holding valve, an opening pressure is required.

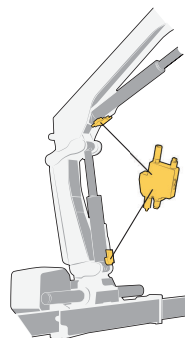

DANGER

It is not permitted to manipulate these devices because you can cause serious accidents.

Only an authorised service workshop can do the servicing, replacement and/or repair of these valves.

2.7. Description of the crane

The loader cranes EFFER 685-955-1405 are compact, fully hydraulically operated goods cranes and fulfil the European Machinery Directive requirements specified in the standard EN 12999.

Stress class HC1-S1-HD5 according to EN 12999.

Maximum lifting capacity:

- EFFER 685 = 60.21 tonne metres
- EFFER 955 = 76.4 tonne metres
- EFFER 1405 = 100 tonne metres

The crane is supplied in many versions from:

- EFFER 685-3S (reach 10.31 metres) to EFFER 685-9S (reach 23 metres)
- EFFER 955-4S (reach 11.68 metres) to EFFER 955-9S (reach 22.94 metres)
- EFFER 1405-4S (reach 10.95 metres) to EFFER 1405-9S (reach 22.04 metres)

The control valve HAWE, the controller SCANRECO and the Progress 3.0 safety system are standard equipment on this model.

The crane type and the manufacturer are marked on the serial number plate.



NOTE

The exact technical information for your crane is shown in the Technical Data.

2.8. Available configurations

Manual extensions	available in combinations:
1 manual extension in crane	685 3S/4S/5S/6S + 1 955 4S/6S/7S + 1
Reversible raised hook extension	685 5S/6S + JIB 6S HD* 955 6S/7S/8S 955 8S + JIB 6S 1405 8S 1405 6S+ JIB 6S 1405 7S/8S + JIB 6S HD 1405 9S + JIB 6S
*HD: Heavy duty	



NOTE

Other manual extensions in crane are available for non-CE markets.

JIBs	available in combinations:
9K (JIB088K)	685 8S + JIB 4S
9C (JIB140C)	685 4S/5S + JIB 4S 685 6S + JIB 4S/6S HD* 955 7S + JIB 6S 955 8S + JIB 4S/6S 1405 9S + JIB 6S
D (JIB260D)	955 6S + JIB 4S/6S HD* 955 7S + JIB 6S HD* 1405 6S + JIB 6S 1405 7S/8S + JIB 6S HD*
*HD: Heavy duty	

NOTE

Manual extensions in JIB are available for non-CE markets.

2nd JIB	JIBs	available in combinations:
A (JIB030A)	D (JIB260D)	1405 8S + JIB 6S HD* + 2nd JIB 2S
*HD: Heavy duty		

Hoists	available in combinations:
1900/2500 daN	685 3S/4S/5S/6S/8S/9S 685 4S/5S + JIB 4S - JIB140C 685 6S + JIB 4S/6S HD* - JIB140C 685 8S + JIB 4S - JIB088K 955 4S/6S/7S/8S/9S 955 7S + JIB 46S - JIB140C 955 8S + JIB 4S/6S - JIB140C 955 6S + JIB 4S/6S HD* - JIB260D 955 7S + JIB 6S HD* - JIB260D 1405 4S/6S/7S/8S/9S 1405 6S + JIB 6S - JIB260D 1405 7S/8S + JIB 6S HD* - JIB260D 1405 9S + JIB 6S - JIB140C
2750/3600 daN	955 4S/6S/7S/8S/9S 955 4S + JIB 4S - JIB260D 955 6S + JIB 4S/6S HD* - JIB260D 955 7S + JIB 6S HD* - JIB260D 1405 4S/6S/7S/8S/9S 1405 6S + JIB 6S - JIB260D 1405 7S/8S + JIB 6S HD* - JIB260D
3500/4500 daN	685 3S/4S/5S/6S/8S/9S 955 4S/6S/7S/8S/9S
4500/5700 daN	955 4S/6S/7S/8S/9S 1405 4S/6S/7S/8S/9S
Snatch block (not compatible with JIBs)	available in combinations:
2 lines pull	all combinations
4 lines pull	955 4S/6S/7S/8S/9S 1405 4S/6S/7S/8S/9S
2750/3600 daN	1405 4S/6S/7S/8S/9S

Hoists	available in combinations:
*HD: Heavy duty	

3. Safety precautions and warnings

3.1. Operating conditions

You may use the crane **ONLY** if:

- You are outdoors or in a space with sufficient ventilation.
- The mean wind velocity is less than 10.7 m/sec (approx. 38 km/h or 24 mph). **Refer to the wind speed tables.**
- Operational temperature range is between -20°C and +40°C.



DANGER

- **Do not use** the crane in a confined space because you could suffocate from the exhaust gases from the vehicle.
- **Never** use the crane in a high wind or storm. When the mean wind velocity exceeds 10.7 m/sec (approx. 38 km/h or 24 mph), the crane will behave unpredictably. **Never** use the crane during a thunderstorm.
- **Never** use the crane at temperatures below -30°C (-22°F), as the steel's properties deteriorate below this temperature.



WARNING

- At temperatures below 0°C (32°F), do not touch the operating levers during the first few minutes.
- In cold weather, the wear on the hydraulic system is greater than at normal working temperatures.

In cold weather, start the crane as follows:

- Engage the power take-off at low rpm.
- Allow the system to idle for a few minutes.
- Operate the stabiliser legs up and down to reach an oil temperature between 10°C and 15°C. Make sure that the temperature is between these values on the controller display.



3.2. Wind conditions

The force of the wind causes stress on the structure independently of its direction.

The main factors that have an effect on the strength of the wind acting on the crane/load are:

1. Wind speed
2. Load shape
3. Working height



NOTE

For further information, refer to the tables at the end of the chapter:

- **TABLE A** shows the Beaufort scale and the permitted wind average speed over 10 minutes at a height of 10 metres.
- **TABLE B** shows the permitted wind speed for operating heights over 10 metres related to the wind gust speed in 3 seconds.

3.2.1. Wind speed

The permitted wind conditions depend on the position of the boom system.

Operation with the boom system above 45° (X area):

- The maximum Beaufort grade is 5a.
- The maximum average wind speed (in 10 minutes) is 36 km/h.
- The maximum wind gust speed (in 3 seconds) is 50 km/h.

Operation with the boom system below 45° (Y area):

- The maximum Beaufort grade is 5.
- The maximum average wind speed (in 10 minutes) is 38 km/h.
- The maximum wind gust speed (in 3 seconds) is 53 km/h.

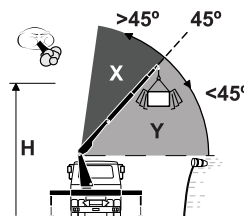

NOTE

Use an anemometer for crane operation over 20 m height.

3.2.2. Load shape

The downwind area of the lifted load can cause an unwanted effect on the behaviour of the crane. Also, the shape and weight of the lifted load can have a greater effect on the forces involved.

Shape: different shapes have different wind effects. For example, a cylindrical shape load has a different wind resistance than a rectangular panel shape load.

Weight: a heavy load has a smaller effect by the wind force compared to a lighter load.

The main factors that have an effect on the operating conditions are:

• **Cw - Drag factor**

This factor is related to the wind effect on the lifted load shape. The factor changes depending on the real lifted load shape:

- **Cw = 2.4** (for unknown shapes).
- **Cw = 2** (for parallelepiped/cube shape loads).
- **Cw = 1** (for cylindrical shape loads).
- **Cw = 0.4** (for special loads).

• **P - Load**

This is the load value to lift in tonnes (t).

• **Ap - Downwind load area**

This value is the downwind area of the load to lift in m².

The operator must do this calculation before lifting operations to determine the maximum permitted wind speed:

1. Calculate the ratio between the load (P) and the downwind load area (Ap):

$$\frac{P}{A_p}$$

- a. If it is 2 or more than 2, refer to the TABLE A and TABLE B to lift the load.
- b. If it is less than 2, go to the next step.

2. Calculate the wind speed reduction coefficient (Cr):

$$Cr = \sqrt{\frac{P \cdot 1.2}{A_p \cdot Cw}}$$

- a. If Cr is 1 or more than 1, refer to the TABLE A and TABLE B to lift the load.
- b. If Cr is less than 1, go to the next step.

3. You must decrease the permitted wind speed value ('V_{table}'), shown in TABLE A and TABLE B, by multiplying it by the reduction coefficient (Cr).

$$V_{max} = V_{table} \cdot Cr$$

Example of the calculation:

Load data	Wind conditions
<ul style="list-style-type: none"> • Shape: cylindrical load • Diameter (D) = 3 m • Load height (h) = 3 m • Weight (P) = 2 t 	<p>Values in the tables ('V_{table}') for a height operation (H) of 10 m:</p> <ul style="list-style-type: none"> • Average speed = 36 Km/h • Gust speed = 50 Km/h
<p>First of all, calculate the main factors Cw and Ap:</p> <ul style="list-style-type: none"> • Cw = 1 • Ap = D * h = 3 * 3 = 9 m² <p>Then:</p> <ol style="list-style-type: none"> 1. Calculate the ratio between the load (P) and the downwind load area (Ap): 	

$$\frac{P}{Ap} = \frac{2}{9} = 0.2$$

As it is less than 2, go to the next step.

2. Calculate the wind speed reduction coefficient (Cr):

$$Cr = \sqrt{\frac{P \cdot 1.2}{Ap \cdot Cw}} = \sqrt{\frac{2 \cdot 1.2}{9 \cdot 1}} = 0.5$$

As it is less than 1, go to the next step.

3. You must decrease the permissible wind speed value (V_{table}), shown in TABLE A and TABLE B, by multiplying it by the reduction coefficient (Cr).
- Average speed:
 $V_{max} = V_{table} \cdot Cr = 0.5 \cdot 36 = 18 \text{ km/h}$
 - Gust speed:
 $V_{max} = V_{table} \cdot Cr = 0.5 \cdot 50 = 25 \text{ km/h}$

Conclusion:

The maximum average speed and gust speed to lift the load to the desired height must be less than the values shown in TABLE A and TABLE B.

3.2.3. Working height (H)

The wind speed increases according to the height (H).

To avoid exceeding the maximum permitted wind speed at the operating height desired, refer to TABLE B to know the maximum permitted ground wind speed.



NOTE

Use an anemometer to know the real speed on the ground below 10 m.

Example:

If the maximum permitted wind gust speed cannot exceed 25 km/h and the operating height is 50 meters, the maximum wind speed measured on the ground (below 10 meters) must not exceed 17 km/h.

3.2.4. TABLE A: Beaufort scale

Permitted wind speed for operating heights below 10 m

Wind Force	Average wind speed (*)				Characteristics
	m/s	km/h	mph	Wind type	
0	0.0 - 0.2	< 1	< 1	Calm	Calm, smoke rises vertically or nearly vertically.
1	0.3 - 1.5	1 - 5	1 - 3	Slight breeze	Wind direction recognisable from smoke plumes. The wind begins to be noticeable

Wind Force	Average wind speed (*)				Characteristics
	m/s	km/h	mph	Wind type	
2	1.6 - 3.3	6 - 11	4 - 7		on the face, while leaves begin to rustle and weather vanes can start to move.
3	3.4 - 5.4	12 - 19	8 - 12	Moderate wind	Leaves and twigs in continuous movement. Small branches begin to move. Dust and paper begin to move over the ground.
4	5.5 - 7.9	20 - 28	13 - 18		
5a	8.0 - 10.1	29 - 36	19 - 22		Intermediate conditions between 4 and 5.
5	10.2 - 10.7	37 - 38	23 - 24	Fairly strong wind	Small leaved branches make swaying movements; crested waves form on lakes and canals.
6	10.8 - 13.8	39 - 49	25 - 31	Strong wind	Large branches move; you can hear the wind whistling in telephone wires; umbrellas can only be held with difficulty.
7	13.9 - 17.1	50 - 61	32 - 38	Severe wind	Entire trees move; the wind causes difficulty when you walk into it.
8	17.2 - 20.7	62 - 74	39 - 46	Stormy wind	Twigs break off, and walking is difficult.
9	20.8 - 24.4	75 - 88	47 - 54	Storm	Causes superficial damage to buildings (chimney pots, roof tiles, and TV antennae are blown off).
10	24.5 - 28.4	89 - 102	55 - 63	Severe storm	Uprooted trees; considerable damage to buildings etc (occurs infrequently on land).
11	28.5 - 32.6	103 - 117	64 - 72	Very severe storm	Causes extensive damage (occurs very infrequently on land).
12	> 32.6	> 118	> 73	Hurricane	



IMPORTANT

Wind force	Permitted boom system position and crane configuration
5a	Boom system in any position (crane in service and out of service)
5	Boom system below 45° from the horizontal (cranes in service)
6	Boom system below 45° from the horizontal (crane without load and out of service)



NOTE

- (*) Speed according to EN 13000. Beaufort scale.
- Refer to the manual of the anemometer for more information about the precise method of measurement.
- Refer to Table B for crane/load heights over 10 meters (H > 10m).

3.2.5. TABLE B - Conversion wind speed

For operating heights over 10 metres related to the wind gust speed (in 3 seconds).

WIND SPEED AS A FUNCTION OF ELEVATION							
Beaufort grade	0	1	2	3	4	5a	5 (*)
Average wind speed (km/h) (over 10 minutes at a height of 10 metres)							
	1	5	11	19	28	36	38
Height	Wind gust speed (km/h) (in 3 seconds)						
10	1.0	7.6	15	27	39	50	53
20	1.1	8.1	17	29	42	54	57
30	1.1	8.5	17	30	44	56	60
40	1.2	8.7	18	31	45	58	61
50	1.2	8.9	18	31	46	59	63
60	1.2	9.1	19	32	47	61	64
70	1.2	9.3	19	33	48	62	65



NOTE

- (*) Wind condition only for the boom system below 45° (Y area).
- Conversion to different measurement units:
 - 1 km/h = 0.2778 m/s
 - 1 km/h = 0.6214 mph

3.3. Definition of this loader crane

Usage of the crane

The EFFER loader crane is used to lift and move loads in the working area permitted by the load plate and the load diagram. The cranes are normally mounted on a vehicle but they can also be mounted on a fixed base plate. The crane can be equipped with a number of lifting accessories/ interchangeable equipment.

Permitted/forbidden use of the loader crane

Permitted duties:

- Loading and unloading cargo from/on vehicles
- Lifting and moving loads from vehicles
- Handling loads with lifting accessories/interchangeable equipment* intended to be used on loader cranes.

*As specified in the documents for the equipment.

Forbidden duties (unless the loader crane is specially prepared for a certain duty following authorisation from Hiab):

- Installing the crane on ships or floating structures
- Continuously using the crane as a production crane in assembly lines, foundries...
- Handling loads, working with submerged boom systems or accessories, in strong currents such as rivers
- Applying pressure downwards
- Pushing/pulling with the boom system against any type of obstacle (wall, ground...)
- Transferring loads of unknown weight to the crane
- Using the JIB upside down (please always refer to the Operator's Manual for your JIB to see what is allowed)
- Putting loads on structures if you do not know their resistance
- Lifting a mass that is partially loaded or attached to another equipment/structure/element

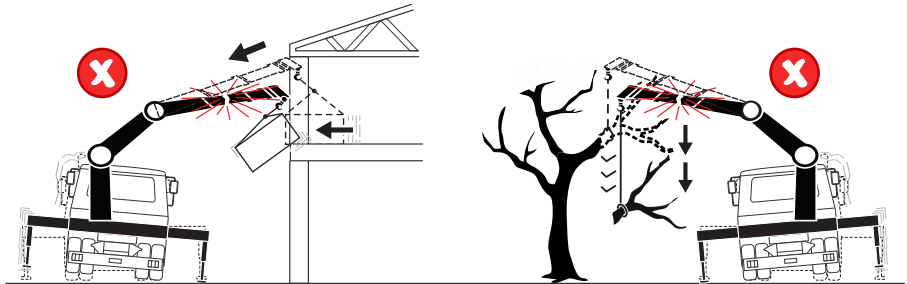

CAUTION

There is a risk of tipping the truck and/or damaging the crane, the load or other structures inside the working area.

- Lifting people
- Using a personnel basket (as the crane must be certified as a MEWP crane by a notified body). Please always refer to the MEWP's Operator's Manual.



DANGER

Lifting people with a crane is never allowed unless it is a MEWP crane. When working in a personnel basket, both feet must have contact with the floor of the basket. Standing on boxes or ladders in the basket can lead to injury or death.

3.3.1. Noise declaration

The following values for emitted noise may be taken as general and conservative values for ordinary installations of loader cranes on normal diesel engine powered trucks. Declared dual-number noise emission values in accordance with ISO 4871:

- Emitted A-weighted sound power level for basic loader cranes in accordance with ISO 3744: LwA = 103 dB (Uncertainty: KwA = 2 dB).
- Emitted A-weighted sound power level for loader cranes with hoist in accordance with ISO 3744: LwA = 107 dB (Uncertainty: KwA = 2 dB).
- A-weighted sound pressure level at loader crane control stations in accordance with ISO 11201: LpA = 95 dB (Uncertainty: KpA = 4 dB).

3.3.2. Signs on the crane

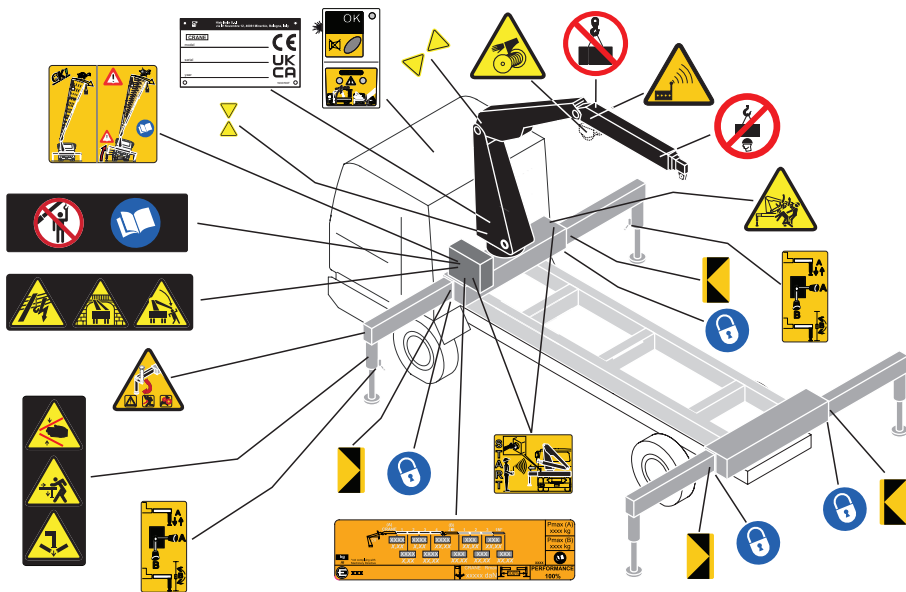

3.3.3. Maximum load

Lifting capacity

Your crane has a certain lifting capacity, expressed in kNm or tm. This lifting capacity is also known as the load moment. The lifting capacity is: the payload at hook multiplied by the outreach in metres that the crane can operate at different positions. The lifting capacity of your crane determines the maximum load your crane may lift within its working zone. However take careful note; the greater the operating radius of the crane, the lower the lifting capacity will be because of the weight of the boom system itself. The load plate and the load diagram on your crane show the maximum loads you may lift in the operating reach of your crane.



DANGER

- Overloading could result in damage to the crane or in the worst case, personal injury or death
- Never increase a hanging load, since that may cause a load holding valve to open and/or the vehicle to turn over.
- Never use the crane with the Progress system switched off.



NOTE

The lifting capacity indicated in the standard crane and crane + JIB load chart does not include the weight of the hose reel, winch, grapple, exchange solenoid valves, manual extensions and any other accessories fitted on the boom system.

Load plate

On the plate is the maximum weight that you may lift at a given outreach, with the 1st boom in the optimum position. In the Technical Data, you will find these values for your crane.

- (A) The maximum capacity of the crane.
- (B) The maximum capacity of the JIB (if fitted).
- (C) The maximum load that the stabiliser leg can apply to the ground.
- (D) The position of the stabiliser extensions according to the load plate.

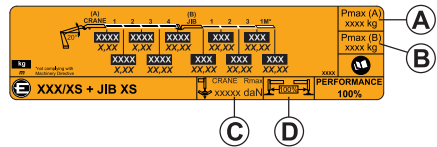

NOTE

Align the yellow arrows signs located on the column and on the 1st boom to reach the maximum load values as the load plate shows.

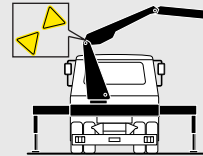

Optimum position

The weight that your crane can lift will be determined by:

- Stability test of your crane on the vehicle.
- Stabiliser extensions positioned and legs pressed to ground.
- The reach at which you are working and the optimum position of the boom.
- The optimal position for your crane is on the load plate.



DANGER

Never exceed the maximum weight on the load plate.

Load diagram

The load diagrams show the maximum loads your crane / JIB (if fitted) / hoist (if fitted) may lift in the entire working zone (manual extensions excluded). The load diagram drawing will also be found in the Technical Data.

The white area is the working zone of the crane.

The load curves show the maximum load that may be lifted at a given outreach and height. For a given maximum load, the possible working zone is to the left of the load curve. The lifting capacity for some cranes is limited in the high lifting area.

Sometimes to lift the maximum loads, you must apply a special hook or a locking device of the extensions. A mark (*, ■, ●, ▲) in the load diagram next to the capacity value indicates where this is necessary.

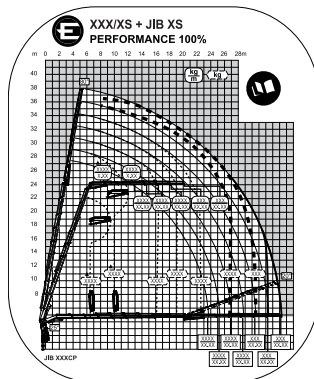

*	Lifting by fixed hook.
■	With a special hook.
■	Maximum load of cranes / JIB limited by maximum hook coupling and/or connection capacity.
●	Maximum load that can be lifted by mechanically locked extensions.
▲	2nd boom and/or JIB not more than -30° below the horizontal. (For 2nd boom/JIB angles greater than -30° , boom extensions must be mechanically locked). For the crane EFFER 1000, this value is -20° .



NOTE

When the feature HSS is activated, the maximum performance could be reduced in vertical positions from the values shown in the load diagram. Deactivate this feature to avoid this situation.



WARNING

Be careful when handling loads in the high lifting area, thus the load/tool does not come into contact with the boom system.

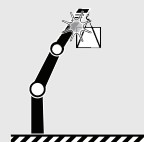



WARNING

Never operate the hydraulic extensions against a solid object when the 1st boom is completely lifted. Do not try to push or compress loads when the 1st boom is fully lifted, as this could cause damage to the 1st boom cylinder.

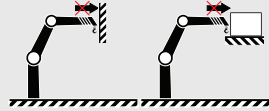

3.3.4. Maximum load moment

If your crane has reached the maximum load moment (lifting capacity), Progress gives a warning and locks any crane movement that will increase the load moment. This is known as the maximum limit situation.

In this situation, only the following movements are allowed:

- crane slewing (only one slewing direction is allowed to go out from the low stability area)
- 1st boom lifting (not allowed if the max performance limit is reached in a low stability area)
- 2nd boom lowering (allowed only if the 2nd boom angle is less than 30°)
- 2nd boom lifting
- extend the boom extensions (allowed only if the 2nd boom angle is under -45°)
- retract the boom extensions
- JIB lowering (allowed only if the 2nd boom Jib is positioned below the horizontal)
- JIB lifting
- hoist lowering

Lifting the load

Make sure that you always have the work in clear view. If you cannot see the load properly, you could cause a fatal accident or serious damage.

Sling length

Always attach the load using the shortest possible sling. The angle between the legs of the sling must not exceed 120°. The maximum working load, (usually known as the working load limit (WLL) in standards) of a multi-legged sling for general purposes, is calculated by multiplying the WLL of a single leg by a mode factor (refer to the table).

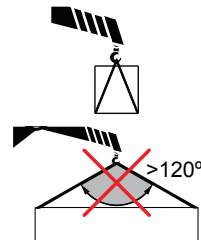

Max angle to the vertical of any sling leg (degrees)	Mode factor two legged sling	Mode factor three and four legged sling
0-45	1.4	2.1
45-60	1.0	1.5

If the angle between the legs of the sling is more than 90°, do not hang the slings directly on the hook. Use a ring hanging from the hook to attach the sling.



NOTE

These instructions do not replace the instructions provided by the chain manufacturer.

Working close to the load

Always try to lift the load with the extension boom retracted, however not completely. The crane then has the greatest lifting capacity. Place the vehicle as close as possible to the load.



Working below ground level

If you have to load or unload below the level of the ground: keep the 1st boom angle to about 10° to 30° above the horizontal plane.



CAUTION

Do not operate the first boom down at the end of stroke (as in the picture).

In this position, cylinders could suffer overpressures or mechanical damages, and as a consequence, the load could fall and cause damage to the crane and/or the adjacent area or, in the worst case, personal injury or death.



Heavy loads

Lift heavy loads with the 2nd boom in the optimum position in relation to the 1st boom. For this, see the load plate on your crane.

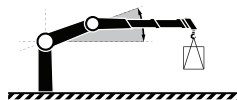

DANGER

Never exceed the maximum permissible loading of the hook.

Heavy loads cannot be handled with the boom straight.

Set the 2nd boom, so there is an angle in relation to the 1st boom.

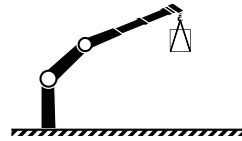

Heavy loads below the horizontal

It might be necessary to lock the boom extensions by a special pin. Unlock the boom extensions as soon as you finish this operation and do not leave the load below the horizontal line for a long time.

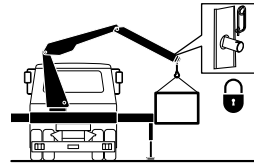

Loads at the extreme limit of the working zone

Also in this case, angle down the 2nd boom somewhat. Only use the 1st boom .



TIP

Make smooth crane movements: operate the crane with various functions simultaneously. In this way you will also prevent the hydraulic system heating up quickly.

3.4. Signals when using a crane



DANGER

- If it is not possible to see the load and the entire working area clearly, the crane operator must follow the instructions and signals given by a qualified person.
- The country-specific regulations for crane operator signals are to be used.

Signals in this manual give a number of standard signals that can be used.

Lift

Raised arm and index finger raised. Circular motion with the hand.



Lower

Arm pointing downwards and index finger down. Circular motion with the hand.

**Stop all crane movements / Hold the load in position**

Raise the open hand, with the palm clearly visible, and arm at shoulder height.

Keep the hand still.

**Emergency stop for all movements by the crane**

Raise the hands and the arms to an oblique angle.

**Very short movement**

Place the hands a very short distance apart, with the palms facing each other. The hands may be held either horizontally or vertically. The next movement may be: Lift, lower, move the lifting gear, change the reach, or turn.



Change the reach

Signal with your hands.

- Sideways movement outwards with both hands. Thumbs outwards.
- Sideways movement inwards with both hands. Thumbs inwards.

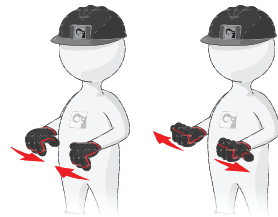

Turn in the direction indicated

Indicate the direction with the hands.

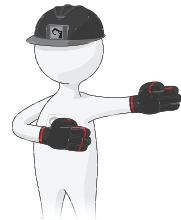

Open the tool

Extend the arms at shoulder height, with the palms facing downwards.

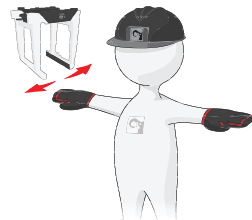

Close the tool

Move both hands close together.

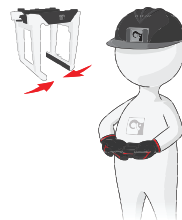

Lift the open tool a little

Extend both arms at shoulder height, with the palms facing upwards. Make vertical movements with both arms outstretched.

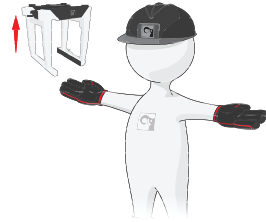
**Keep the tool in position briefly**

Raise the hand drooping slightly, with the fist clenched.



3.5. Use of the crane

Starting crane operation



DANGER

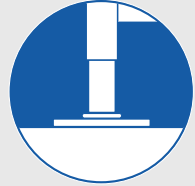

- Make sure that you comply with the regulations of the country in which you use the crane (for example, certificate, safety helmet, and other personal protection devices).
- Check that the ground is sufficiently flat and firm.
- Verify that the ground is not uneven. Be careful with sewers, cellars, excavations etc.
- To make sure that the vehicle stays in its position, always engage the parking brake and place chocks under the wheels.
- Lower the stabiliser legs only on to a flat and firm surface.
- Do not lower the stabiliser legs on the edge of an embankment, soft shoulder, slope etc.
- Make sure that you can see the stabiliser legs and stabiliser extensions when you are operating them.
- The stabiliser legs must not sink in! Use support plates that are large and firm enough for your crane. The plates must not bend because of the load weight.
- Verify that the support plates do not sink as you gradually lift the load.



DANGER

- Do not stand in front of the hydraulically operated stabiliser legs when you are operating them!
- Never use the stabiliser legs as a parking brake, since the vehicle could start to slide.
- Slide the stabiliser extension, on both sides of the vehicle, completely out if possible. Then lower the stabiliser legs for support.
- Never operate the stabiliser legs/ extensions if there is a load suspended from the crane.



**WARNING**

- Use low force when you put the stabiliser legs on the ground.
- Do not raise the vehicle with the stabiliser legs! If you do, you can cause damage to the stabiliser legs.
- Check that the interchangeable equipment and lifting accessories are in good condition!

Interchangeable equipment is usually attached to the boom tip (e.g. JIB, hook, grapple, rotator, etc)

Lifting accessories are connected to the standard load hook (e.g. slings, chains, shackles etc).

**DANGER**

Do not stand in front of the boom system when operating the crane out of transport position.

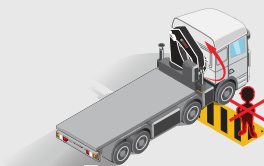
**3.5.1. Preparations for use****DANGER**

Make sure that there are no unauthorised persons within the operating range of your crane!

To mark the working area correctly, think about the space that the crane will need to lift the load (direction of the lift, size of the load).

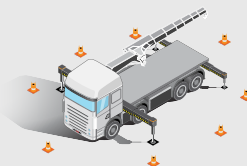
**CAUTION**

- Put on your vehicle's warning lights.
- Make sure that the parked truck does not block emergency exits, pedestrian roads or no-parking zones unless you have permission.
- Make sure that both the truck and the crane do not block the visibility of important signs for other users of the area (for example, road signs).



DANGER

- If a part of the crane comes in contact with an electricity line, you will be electrocuted!
- Always keep the following minimum distances between the crane and overhead electricity lines, unless otherwise prescribed by national rules.

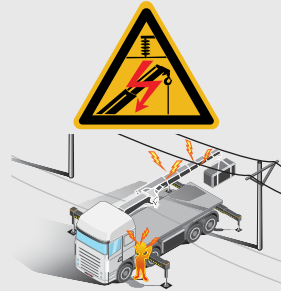

Minimum distance between crane and overhead electricity lines		
Voltage (V)	Minimum distance to an insulated conductor	Minimum distance to an uninsulated conductor
<500 V	0.5 m	2 m
500-40000 V	1.5 m	4 m
>40000 V	2.0 m	6 m
Voltages are found:		
up to 500 V:		to buildings
500-40000 V:		trams, trains
over 40000 V:		power transmission



DANGER

When you go into the control station (high-seat, cabin, platform) remove all jewellery, loose clothing, or other hanging items from your body (for example, rings, scarfs, bracelets...). Jewellery, loose clothes, and other hanging items can be caught in some parts of the crane.



DANGER

When you go into or out from the control station, use only handles and supports on the crane that were specifically made to help the operator to go into or out from the control station.

**WARNING**

Make sure that you know the position of all the emergency stop buttons on your crane and on the controller.

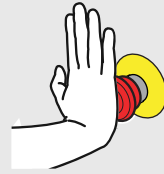
**3.5.2. Crane operation****DANGER**

Your crane has a control system.

The control system will help you to work safely. Nevertheless, you remain responsible for the safe use of the crane!

Therefore, always work according to the operating instructions!

In an emergency situation, push immediately any of the emergency stop buttons. This will stop all crane movements and prevent the free movement of the load.



DANGER

- Keep checking that there are no unauthorised persons within the operating reach of the crane!
- Make sure that you can always see the load!
- If your view of the load is not sufficient, obey the instructions and signals given by a qualified person.
- See the list of signals. Make sure that you and the person assisting you know these signals.
- Pay attention to the safety of the person giving the signals!
- Never walk or stand under a suspended load!
- During operation, never stand below the boom system or load!
- Do not slew the crane, nor lift the first boom, nor lift the second boom into their ends positions at full speed. This can damage the crane.
- Always stay away from moving parts during operation.
- Make sure that the load is attached correctly to the tip of the crane before you start to lift.





WARNING

- Never push a load along the ground, or the vehicle's load space, with the extension boom. This can cause damage to the boom system. This will lead to expensive repairs.
- Never use the extension boom as a jack. This could damage the slewing bearings and the connection between the crane column and the crane base.
- Always lift the load from the ground before you start to slew. Do not tow the load over the ground. This can damage the boom system.
- If you are working with loads in restricted spaces (for example, windows):
Check that the boom system can move up and down freely.
The boom system will bend somewhat, when loading and unloading the crane.
- If the boom system is in a high position (first boom above 70°), do not allow the boom to lower at full speed. The crane could go into an uncontrolled movement.
- Be careful when handling loads in the high lifting area, thus the load/tool does not come into contact with the boom system.

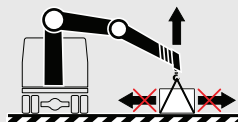

CAUTION

- Operate the crane using smooth and gentle lever movements.
- If a cylinder is at its end position, free the operating lever. Otherwise overheating can occur.
- If the cabin area and/or the stabiliser area are not defined, you must be very careful to avoid hitting them and causing an accident during the crane operation.



TIP

To prevent damage to your crane, we recommend that you do not leave the load hanging on the hook for a long time. Always leave the (load/tip of the crane) resting on a stable surface before a break or park the crane.

3.5.3. Driving with the crane



DANGER

- Never move/drive the vehicle if there is a load suspended from the crane.
- Before you move the vehicle:
Check that there is no pump flow to the main control valve. The PTO or power supply must be disengaged. The operating system must be switched off!
- Pay attention to the width and height of the crane in the transport position. The crane must stay within the width of the truck.
- Make sure the stowed crane and its equipment cannot fall, hit bridges, tunnels, other vehicles etc.
- Pay attention to overhead power lines! Make sure that no part of the crane ever comes in contact with overhead power lines.

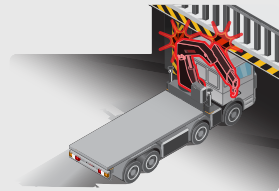
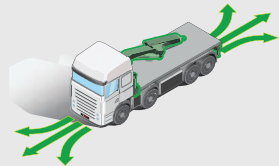

NOTE

- For further instructions, refer to the vehicle's manual(s).
- Make sure that you always obey local traffic rules when driving with a crane.

3.5.4. Use of lifting accessories and interchangeable equipment



DANGER

- Only use interchangeable equipment intended to be used on loader cranes as specified in the documents for the equipment.
- When using lifting accessories, follow the instructions supplied with the equipment!
- Watch out for hazards!
- Never try to adjust lifting accessories when you are working on the crane!

After lifting accessories and/or interchangeable equipment have been fitted:

1. Check that they are securely fixed.
2. Only after this, should you use your crane.

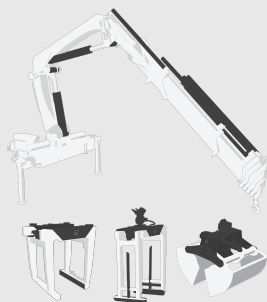

WARNING

Always insert the locking pin in the shaft for all the attachments on the tip of the crane (hook, top-roller, pulleys...).

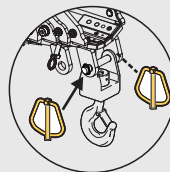

WARNING

If you attach/detach equipment to/from the tip of the crane and the boom system is not in horizontal position, stay away to avoid getting caught between the boom extensions as it is normal that they can move towards each other.



WARNING

- Be careful that your fingers do not get trapped.
- Dirt can damage the hydraulic system:
 - Clean the couplings, when connecting and disconnecting interchangeable equipment with hydraulic connections.
 - Always use the plastic cover protections on the hydraulic connections when disconnecting them.

3.5.5. Use of demountable cranes



DANGER

- Make sure that there are no unauthorised persons in the immediate vicinity of the crane. When mounting/demounting the crane on/from the vehicle, people can suffer fatal crushing injuries!
- After setting up, verify that the crane is properly locked!



WARNING

Be careful when mounting/demounting the crane on/from the vehicle as rough handling can seriously damage the crane or the vehicle.

3.5.6. Ending crane operation



DANGER

Always end crane operation as follows:

- After use, always place the crane in the transport position!
- Withdraw the stabiliser legs and stabiliser extensions.
- Check that the locking mechanisms are properly locked.
- Switch off the operating system.
- Disengage the PTO or power supply after work.
- If you drive with the PTO or power supply engaged, this will cause serious damage to the PTO/gearbox combination.
- Only after doing the above, you can drive the vehicle away.

4. The control system

4.1. Control System Progress 3.0

Progress control system is an electronic device that allows you to work safely with the crane.

The control system:

- Monitors the crane operation and prevents unsafe actions.
- Adjust the speed in certain working conditions.
- Monitors truck stability according to the position of the stabiliser system.
- Makes operation easier.
- Makes troubleshooting easier.

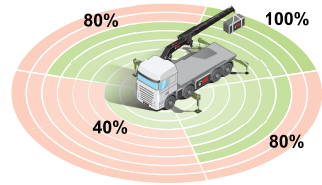

Crane version	Control valve	Control System	Controller
685 CE 955 CE 1405 CE	HAWE	Progress 3.0 (with/without SENSE [option])	Scanreco Scanreco HD



NOTE

The control system provides a large number of functions. Certain features are standard, others are options.

4.2. How the control system works

On the crane, there are various sensors and indicators that send signals about the crane load, position, and movements to a central microprocessor. The microprocessor then decides how the crane can be operated and stops prohibited movements, and adjust the speed according to the following:

- Angular position of the crane boom system
- Position of the stabiliser extension and ground support
- Value of the load applied to the hook
- Number of simultaneous movements requested
- Speed of the functions set with the controller.

Fault monitoring

If there is a fault in the control system, it will give an immediate warning.

Depending on the fault, some crane movements could be blocked until the fault is corrected. When the fault is important, the use of the crane is blocked completely.



DANGER

Never try to repair the control system yourself. Repairs may only be made by an authorised service workshop!

4.3. Components of Progress 3.0

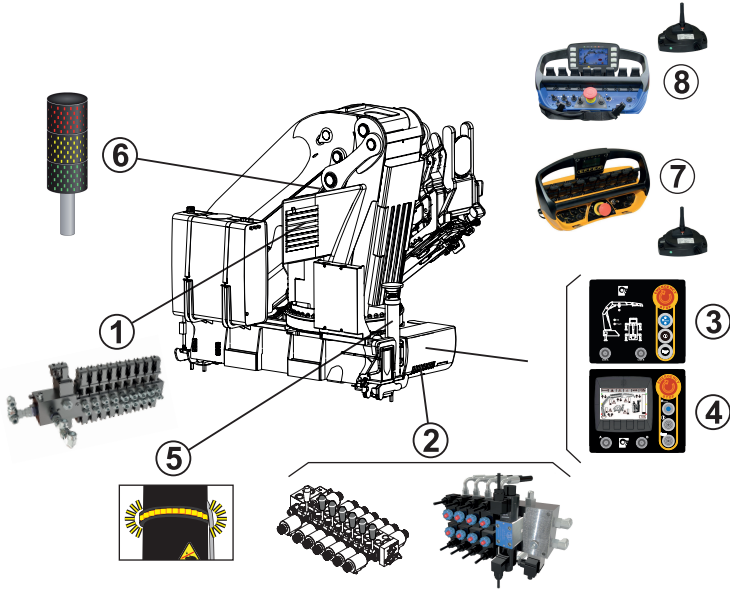

(1) Main control valve	(4) User interface with display panel [option]	(7) SCANRECO controller [option]
(2) Stabiliser control valve	(5) Stabiliser leg lamp [option]	(8) SCANRECO HD controller [option]
(3) User interface with LEDs [option]	(6) Warning lamp	

4.4. Standard symbols and functions of the crane

These symbols can be shown:

- On the control valve levers.
- On the controller (if delivered).



NOTE

For normal operation, you will use a controller. You can read about the symbols displayed on it in the dedicated section of this operator's manual.

By default, the symbol on the controller corresponds to the positive movement of the levers. To operate the opposite movement of that symbol, move the lever in the opposite direction.

Always operate the lever according to the function on the symbol sign.

Basic crane symbols and functions

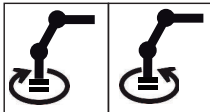
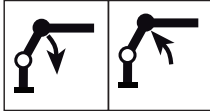
SYMBOLS	FUNCTIONS
	Slewing
	First boom

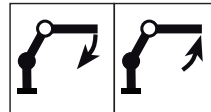
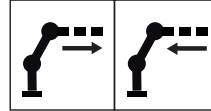
SYMBOLS	FUNCTIONS
	Second boom
	Hydraulic extensions

Extra symbols and functions (if delivered)

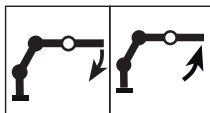
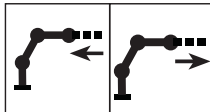
SYMBOLS	FUNCTIONS
	JIB cylinder
	JIB extensions

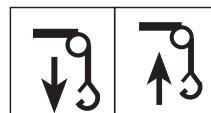
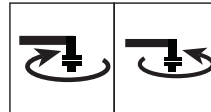
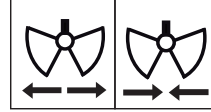
SYMBOLS	FUNCTIONS
	Hoist
	Rotator
	Grapple

4.5. Main control valve

An Effer remote-controlled crane cannot be operated from the main control valve, but only through a controller. Thus, the main control valve becomes the control station only for emergency operation (refer to the section “Emergency operation” for more information).

The speed of a function corresponds to the extent of the lever movement, regardless of the load and other functions, as long as the oil flow is sufficient. When the oil flow is insufficient, one or more functions might reduce their speed.

When the controller is used, the oil flow is allocated by means of automatic flow sharing.

In the inlet side, there is also the HPCO (High Pressure Carry Over), a deviating element that sends the oil to the crane or to the stabiliser valves block.

4.6. Different stabiliser control valves

Different stabiliser control valves that you can find on the cranes:

- Stabiliser control valves with emergency screws.
- Stabiliser control valves with emergency levers.

An Effer remote-controlled crane cannot operate the stabiliser system from the stabiliser control valve, but only through a controller. Thus, the stabiliser control valve becomes the control station only for emergency operation (refer to the section “Emergency operation” for more information).

4.7. User Interface with LEDs [option]



NOTE

The type of interface available on your crane depends on its configuration.

Buttons:

- **(A)** ON/OFF button. You hear a sound when you activate it.
- **(B)** Emergency stop button
- **(C)** Reset LED
- **(D)** Horn (manual activation)
- **(P)** Crane cylinders pressure LEDs
- **(S)** Stabiliser system cylinders status/position
- **LED OK:**
 - Green light on: the crane is ready to work.
 - Green light flashing: the crane is not ready to work.
- **LED Fault:**
 - Red light on: there is a fault.

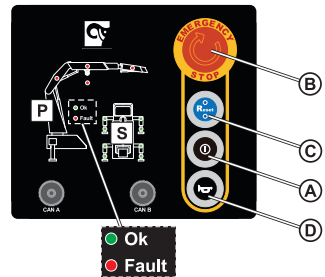



4.7.1. Indicator LEDs on the User Interface





NOTE

When you switch the control system on, an automatic LED test is done.
All the LEDs are illuminated to detect the presence of defective LEDs.

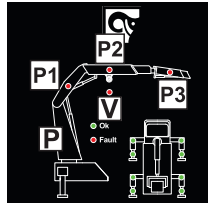
	LEDs flashing slowly 	LEDs flashing fast 	LEDs steady 
Crane: (P1), (P2), (P3)	90% of max. performance	100% of max. performance	Overloaded
Hoist: (V)	90% of max. performance	100% of max. performance	-



	LEDs flashing slowly 	LEDs flashing fast 	LEDs steady 
Stabiliser extensions: (S1-a), (S2-a), (S3-a), (S4-a)	Extended below 50%	Extended over 50%	Extended 100%
Stabiliser legs: (S1-b), (S2-b), (S3-b), (S4-b)	-	-	Set to the ground

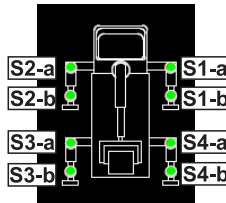

4.8. User interface with the display panel [option]



NOTE

The type of interface available on your crane depends on its configuration.

Buttons:

- (A) ON/OFF button. You hear a sound when you activate it.
- (B) Emergency stop button
- (C) Reset LED
- (D) Horn (manual activation)
- (E) LEDs
- (P) Display panel

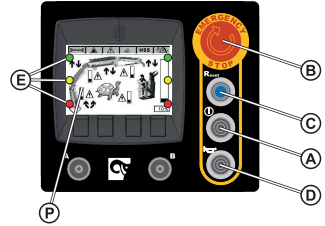

4.8.1. Display panel







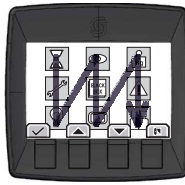

The display panel provides the operator with information on the crane status, features active, and errors.

How to navigate the display panel

General functions/icons	
	<p>Push one of the four function buttons to start.</p> <p>Every available option will appear on the top of these buttons on the screen.</p>
	<p>Access to the main menu display.</p>
	<p>Toggle between options.</p> <p>NOTE: A selected item appears with a darker background, while a non-available item has a lighter colour.</p>
	<p>Confirm or access a submenu.</p>
	<p>Go back.</p>
	<p>Option only available for service personnel. If needed, contact an Effer authorised workshop.</p>

Main menus on the display panel







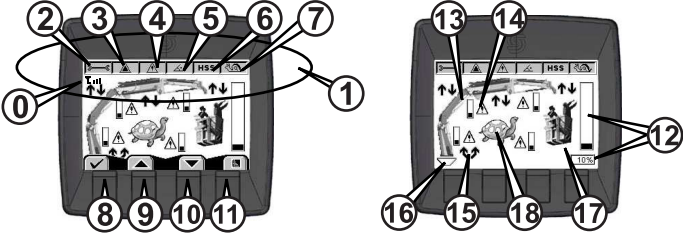

	<p>Access time counters:</p> <ul style="list-style-type: none"> - Lifetime: total time the crane was active. - Current time and date. 		<p>Data history (service personnel only).</p>
	<p>Access maintenance:</p> <ul style="list-style-type: none"> - Dirty oil filter info: total time + last 5 times of operation with clogged filter. - Oil filter changed: date. - High temperature info: total time + last 5 times of operation with high temperature (>80°). - Last service (service personnel only). - System by-pass: total time + last 5 times of operation with disabled safety features. 		<p>Screen/page options:</p> <ul style="list-style-type: none"> - Date/time - Date format - Languages (English/Italian) - Brightness - Contrast - Unit of measure
	<p>Crane settings:</p> <ul style="list-style-type: none"> - Working light on the boom system: ON/OFF. - Password setting (for emergency operation and service personnel). - Utilities (speed/hoist setting, manual/remote, stabilisers movement, emergency function). 		<p>Liftable weight:</p> <p>Current weight on the hoist or radio hook.</p>
	<p>Info system:</p> <ul style="list-style-type: none"> - Geometric blocks status. - Pressure and angle values. - Crane consensus info (service personnel only). - Input/output status of the system control units. 		<p>Warning/errors:</p> <p>If a warning/error is active, it shows:</p> <ul style="list-style-type: none"> - The total number - The code - A brief description <p>NOTE: If more than one warning/error is active, the screen shows each one every 2 seconds</p>
			<p>Movement management:</p> <p>Shows the use of the levers according to the movement percentage allowed by the control system.</p>

Main display for stabiliser system operation

<p>(0) RADIO SIGNAL</p> <p><i>Indicates the level of the radio signal.</i></p>	<p>(12) STABILISER EXTENSIONS POSITION</p> <p><i>Indicates the position of the stabiliser extensions in percentage (%).</i></p>
<p>(1) CRANE STATUS BAR</p>	<p>(13) STABILISER ROTATION POSITION [option]</p> <p><i>Indicates the angular position.</i></p>
<p>(2) MAINTENANCE ALERT</p> <p><i>Indicates that maintenance inspection is needed (the buzzer makes 4 beeps every 20 minutes).</i></p>	<p>(14) CRANE STABILISER LEGS STATUS</p> <p><input type="checkbox"/>: stabiliser legs not set on the ground. <input checked="" type="checkbox"/>: stabiliser legs set on the ground.</p>
<p>(3) ERROR ALERT</p> <p><i>Serious error symbol.</i></p>	<p>(15) ALLOWED MOVEMENT ARROWS</p> <p>: movements allowed. : movements not allowed.</p>
<p>(4) WARNING ALERT</p> <p><i>Generic warning symbol.</i></p>	<p>(16) REAR AUXILIARY STABILISER LEGS STATUS</p> <p><input type="checkbox"/>: stabiliser legs not set on the ground. <input checked="" type="checkbox"/>: stabiliser legs set on the ground.</p>
<p>(5) TIPPING LIMIT ALERT [option]</p>	<p>(17) FRONT AUXILIARY STABILISER LEGS STATUS</p> <p><input type="checkbox"/>: stabiliser legs not set on the ground. <input checked="" type="checkbox"/>: stabiliser legs set on the ground.</p>
<p>(6) MENU ACCESS ENABLING</p>	<p>(18) TRUCK LEVELLED STATUS [option]</p>
<p>(8) CONFIRMATION or MENU button</p>	
<p>(9) ARROW “UP” button</p>	
<p>(10) ARROW “DOWN” button</p>	
<p>(11) PREVIOUS PAGE button</p>	

Main display for crane operation

	
<p>(0) RADIO SIGNAL <i>Indicates the level of the radio signal.</i></p>	<p>(11) PREVIOUS PAGE button</p>
<p>(1) CRANE STATUS BAR</p>	<p>(12) CRITICAL PRESSURE BAR <i>Indicates the percentage (%) of pressure inside the most critical cylinder.</i></p>
<p>(2) MAINTENANCE ALERT <i>- Indicates that maintenance inspection is needed (the buzzer makes 4 beeps every 20 minutes). - Indicates (if activated) cabin/operator protection system.</i></p>	<p>(13) WORKING PRESSURE BAR <i>Indicates the percentage (%) of pressure inside the cylinder of each single movement.</i></p>
<p>(3) ERROR ALERT <i>Serious error symbol.</i></p>	<p>(14) WARNING OR ERROR ALERT <i>Indicates that the pressure in the lifting cylinder is 90% or more of the permitted one.</i></p>
<p>(4) WARNING ALERT <i>Generic warning symbol.</i></p>	<p>(15) ALLOWED MOVEMENT ARROWS : movements allowed. T: movements reaching the end of the stroke. : movements not allowed.</p>
<p>(5) ANGULAR LIMIT ALERT <i>Angular movement limitation alert.</i></p>	<p>(16) SLEWING OPERATION ALERT : slewing full speed operation. : slewing reduced speed operation.</p>
<p>(6) HSS ACTIVE <i>Boom extension regenerating active.</i></p>	<p>(17) USED ACCESSORY ALERT <i>Symbol representing the accessory used: MEWP, Hoist, Grapple, 2nd JIB.</i> </p>
<p>(7) SPEED REDUCTION ACTIVATED</p>	<p>(18) AUTOMATIC SLOWDOWN ALERT <i>- Without symbol: full speed. - With symbol: slowdown speed active.</i></p>
<p>(8) CONFIRMATION or MENU button</p>	
<p>(9) ARROW "UP" button</p>	
<p>(10) ARROW "DOWN" button</p>	

4.9. Lamps on the stabiliser legs [option]

A lamp on each stabiliser leg is used to warn the surrounding about ongoing activity, by amber light indication.

System ON: the stabiliser leg lamps light up.



4.10. Warning lamp on the column

If necessary, the system sends both visual and audible signals through a warning lamp, red (1), yellow (2), and green (3) on the column with a horn (4).

In all EFFER remote-controlled cranes the green lamp lights to alert that the crane is in operation mode.

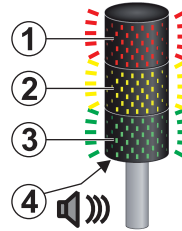

Explanation of the warning light symbols:

Blinking light	
Steady light	

Explanation of the horn symbols:

Single sound		Quick intermittent sound	
Double sound		Slow intermittent sound	
Continuous sound		Nearly continuous sound	

4.11. SCANRECO controller

The SCANRECO controller system consists of:

- a controller unit with buttons/selectors and levers/ joysticks
- a receiver
- an emergency cable
- two batteries
- a battery charger and its accessories
- a belt/shoulder strap



The controller normally communicates with the crane through the receiver via radio, but it can also be used with a cable (when the batteries are discharged or when the use of radio frequencies is forbidden).



CAUTION

- Use the support strap for safe operation.
- Never leave the remote unattended.
- Disconnect it and store it in a safe place when not in use.



NOTE

- For safety reasons, and to minimise battery consumption, the controller automatically turns off after 5 minutes of inactivity.
- To have a correct communication between the controller and the crane system, the controller cannot be more than 100 meters away from the crane without large obstacles in between.

4.11.1. Buttons, selectors and LEDs

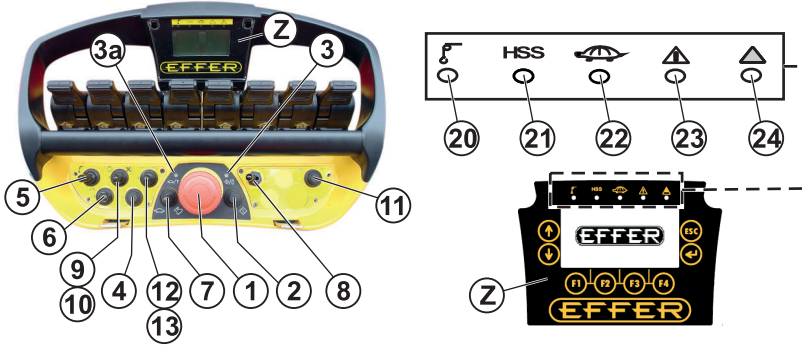





<p>(1) Emergency stop button.</p>	<p>(4) Selector/button for additional equipment [option].</p>	<p>(8) Operation selector mode:</p> <ul style="list-style-type: none"> • Left: CRANE mode (CRANE) • Right: STABILISER SYSTEM mode (STAB) • Centre [option]: (TRUCK WALLS)
<p>(2) Button:</p> <ul style="list-style-type: none"> • Activate the controller. • Reset: push it to reset warnings and alarms. • Horn 	<p>(5) Selector for additional equipment:</p> <ul style="list-style-type: none"> • Left: Hoist • Right: additional equipment 	
<p>(3) LED for battery status:</p> <ul style="list-style-type: none"> • On: remote on and the battery is charged. • Flashing: the battery must be replaced. 	<p>(6) Speed selector mode:</p> <ul style="list-style-type: none"> • Left: reduced speed • Right: HSS • Centre: standard speed 	<p>(9) Truck engine on.</p>
		<p>(10) Truck engine off.</p>
<p>(3a) LED for radio connection:</p> <ul style="list-style-type: none"> • Flashing: the transmission is bad. 	<p>(7) Speed adjustment:</p> <ul style="list-style-type: none"> • 5 positions based on preset values. 	<p>(11) Lights ON/OFF, activation of special features for some models (i.e. 7th or 9th extension with cylinder inside the extension, etc...)</p> <p>(12) Rpm increase.</p> <p>(13) Rpm decrease.</p>

LEDs

(20)	Fixed green LED: hoist is active. Flashing green LED: hoist is active with automatic rope movement enabled (AWC).	(23)	Fixed yellow: warning due to three possible causes: - max. geometric configuration reached. - close to the max. crane performance limit. - stabiliser not set on to the ground. For further information about the warnings present, go to the menu (F3).
(21)	Fixed yellow LED: HSS is active.		
(22)	Blinking green: automatic max. speed reduction during the operation.	(24)	Fixed red: alarms. For further information about the alarms present, go to the menu (F3).

Buttons for the display (Z)

	Arrow keys to move inside the display (move between options, select new pages).	 ESC button: exit any page.	 ENTER button: confirm button.
		Multifunctional button: push to access data. <ul style="list-style-type: none"> • F1: Settings • F2: Visualisations • F3: Warnings/Alarms • F4: Oil temperature and fan(s) speed 	

Locking the controller:

Push the emergency button.

Unlocking the controller:

1. Release the emergency button.
2. Push and hold for at least two seconds the button (2) to activate the controller. The lights (3) will turn on.

4.11.2. Displays

The display shows information about the operation of the crane, options selected, and errors.



NOTE

You might have different images on your screen depending on the configuration of your crane.



NOTE

- Use the buttons on the sides of the controller display to select the desired icon and to navigate between the different displays (that you access after selecting an icon).
- Use the ENTER button to confirm the selection.
- Use the ESC button to exit the selection.

Stabiliser displays

When you lift up and turn the selector (8) to STAB, the 'STAB ALLOW' or 'STAB RECOVERY ALLOW' display is shown. After a few seconds, the display changes into the stabiliser status displays according to the crane configuration.

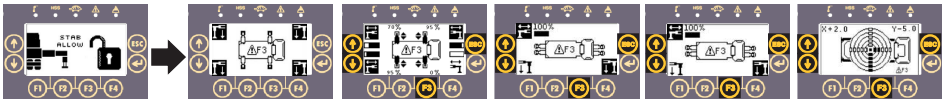





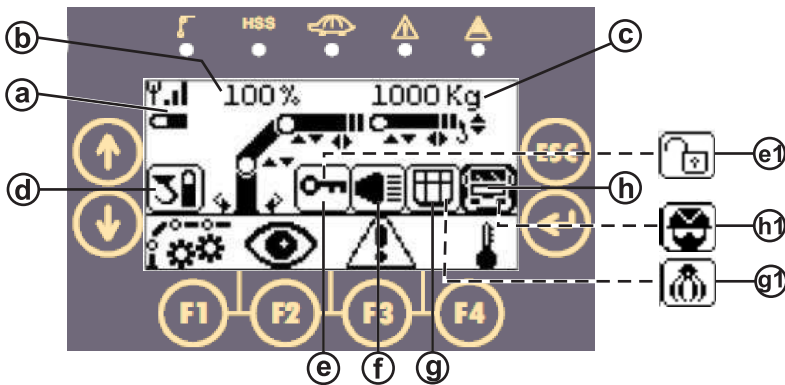

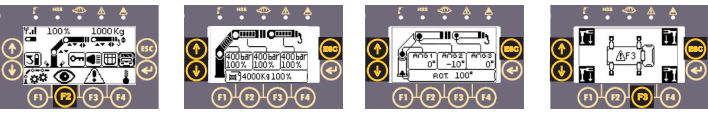

Crane displays

When you lift up and turn the selector (8) to CRANE mode on the controller, the main display is shown. It shows the crane configuration and the movements permitted with the respective arrows.

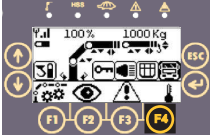

(a)	Battery status	(f)	Lights enabled [option]
(b)	Limit load percentage	(g)	MEWP mode [option]
(c)	Weight detected [option]	(g1)	Rotator/grapple mode [option]
(d)	Radio hook battery status [option]	(h)	Cabin protection enabled [option]
(e)	Not in use	(h1)	Operator protection enabled [option]
(e1)	Progress bypass enabled		

<p>F1: Settings</p> 	<p>Set the hoist pulls on the tip of the crane (n. of winch shots/lines) or set the radio hook according to the hook installed.</p>  <ul style="list-style-type: none"> - Push [F1] to set the hoist pulls on the tip of the crane (n. of winch shots). Change the number with the arrows and confirm with the ENTER button. - Push [F2], [F3] or [F4] to set the radio hook according to the hook installed. Confirm the selection with the ENTER button.
<p>F2: Visualisations</p> 	<p>View all the information related with the crane and stabiliser legs status.</p>  <ul style="list-style-type: none"> - Actual percentage of the max. lifting pressure permitted. - Pressure on the lifting cylinders. - Angles of the lifting booms. Position of the column and the boom system. - If a 2nd JIB is applied to the JIB, on pressing the down arrow button only the information related to the 2nd JIB will be displayed. - Hoist weight lifted. - Stabiliser legs set or not set on to the ground. - Push [F3] to go directly to the warning/alarms display.
<p>F3: Warnings/ Alarms</p> 	<p>View all the warnings and alarms status.</p> 

<p>F4: Oil temperature/ Fan(s)</p> 	<p>View the oil temperature and fan(s) speed. Push [F3] to go directly to the warning/alarms display.</p>  
---	---

Display when an emergency button is pushed

If you push an emergency stop button, the display will show an appropriate message.

If you push the emergency stop button on the controller, the controller display will turn off.



Depending on the control station where you push the button, you will see a different image on the display (Box A (main panel), MEWP). If the crane is on stand-by, push and release one of the emergency stop buttons for operation.

Communication error

During the crane operation, this page may be displayed to indicate the loss of radio communication between the transmitter and the receiver of the controller



4.11.3. Standard functions and symbols













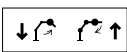

NOTE

The function corresponding to each lever depends on the configuration of the specific crane. The following tables are examples.

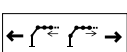
Crane

Lever/ Joystick	Component	Lever/Joystick position		Movement
(A)	Slewing		1	clockwise slewing
			2	counterclockwise slewing

Lever/ Joystick	Component	Lever/Joystick position		Movement
(B)	1st boom	 	1 2	down (folding) up (unfolding)
(C)	2nd boom	 	1 2	down (folding) up (unfolding)
(D)	Hydraulic extensions	 	1 2	out (extracting boom extensions) in (retracting boom extensions)
(E)	JIB cylinder [option]	 	1 2	down (folding) up (unfolding)
(F)	JIB extensions [option]	 	1 2	out (extracting JIB extensions) in (retracting JIB extensions)
(G)	Hoist [option]	 	1 2	rope down rope up

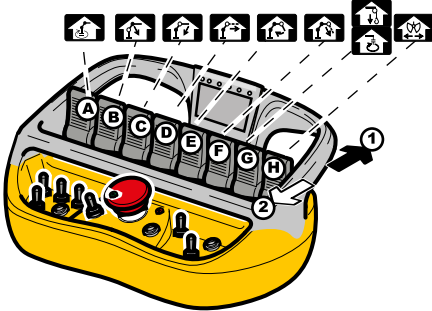
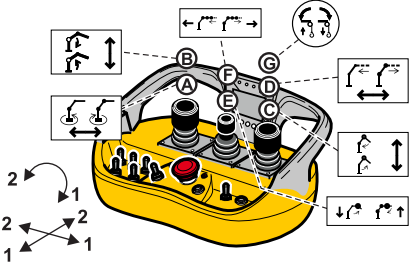
Lever/ Joystick	Component	Lever/Joystick position	Movement
	Rotator [option]		1 clockwise rotation 2 counterclockwise rotation
(H)	Grapple [option]		1 grapple (opening/closing) 2 grapple (opening/closing)
			











Stabiliser system (rear cabin installation)

Lever/ Joystick	Component	Lever/Joystick position	Movement		
(A)	Right crane stabiliser		H + A1/A2 out/in (stabiliser extension)		
			G + A1/A2 down (CW) / up (CCW) (stabiliser leg)		
(B)	Left crane stabiliser		H + B1/B2 out/in (stabiliser extension)		
			G + B1/B2 down (CW) / up (CCW) (stabiliser leg)		
(B)	Left crane stabiliser (CroSStab option)		H + B1/B2 out/in (stabiliser extension)		
			G + B1/B2 down (CW) / up (CCW) (stabiliser leg)		
(C)	Left auxiliary stabiliser		H + C1/C2 out/in (stabiliser extension)		
			G + C1/C2 down/up (stabiliser leg)		
(D)	Right auxiliary stabiliser		H + D1/D2 out/in (stabiliser extension)		
			G + D1/D2 down/up (stabiliser leg)		
(E)	Front/rear auxiliary stabilisers [option]		H + E1/E2 out/in <table border="1" style="display: inline-table; vertical-align: middle;"> <tr><td>H in 1 Front</td></tr> <tr><td>H in 2 Rear</td></tr> </table>	H in 1 Front	H in 2 Rear
			H in 1 Front		
H in 2 Rear					
G + E1/E2 down/up <table border="1" style="display: inline-table; vertical-align: middle;"> <tr><td>G in 1 Front</td></tr> <tr><td>G in 2 Rear</td></tr> </table>	G in 1 Front	G in 2 Rear			
G in 1 Front					
G in 2 Rear					
(F)	CroSStab [option]		F + B1 rotation out		
			F + B2 rotation in		
(G)	Stabiliser leg		<p>In position 1 or 2, activates the stabiliser leg movements.</p> <p>Use then the levers from (A) to (E) to operate the desired stabiliser extension in the desired direction 1 or 2.</p>		
(H)	Stabiliser extension		<p>In position 1 or 2, activates the stabiliser extension movements.</p> <p>Use then the levers from (A) to (E) to operate the desired stabiliser extension in the desired direction 1 or 2.</p>		
			<p>CW: clockwise rotation of stabiliser leg.</p> <p>CCW: counterclockwise rotation of stabiliser leg.</p>		

Stabiliser system (rear body installation)

Lever/ Joystick	Component	Lever/Joystick position	Movement	
(A)	Left crane stabiliser		H + A1/A2	out/in (stabiliser extension)
			G + A1/A2	down (CW) / up (CCW) (stabiliser leg)
(B)	Right crane stabiliser		H + B1/B2	out/in (stabiliser extension)
			G + B1/B2	down (CW) / up (CCW) (stabiliser leg)
(B)	Right crane stabiliser (CroSStab option)		H + B1/B2	out/in (stabiliser extension)
			G + B1/B2	down (CW) / up (CCW) (stabiliser leg)
(C)	Right auxiliary stabiliser		H + C1/C2	out/in (stabiliser extension)
			G + C1/C2	down/up (stabiliser leg)
(D)	Left auxiliary stabiliser		H + D1/D2	out/in (stabiliser extension)
			G + D1/D2	down/up (stabiliser leg)
(E)	Front/rear auxiliary stabilisers [option]		H + E1/E2	H in 1 Front
				H in 2 Rear
			G + E1/E2	G in 1 Front
				G in 2 Rear
(F)	CroSStab [option]		F + B1	rotation out
			F + B2	rotation in
(G)	Stabiliser leg		In position 1 or 2, activates the stabiliser leg movements. Use then the levers from (A) to (E) to operate the desired stabiliser extension in the desired direction 1 or 2.	
(H)	Stabiliser extension		In position 1 or 2, activates the stabiliser extension movements. Use then the levers from (A) to (E) to operate the desired stabiliser extension in the desired direction 1 or 2.	
			<p>CW: clockwise rotation of stabiliser leg.</p> <p>CCW: counterclockwise rotation of stabiliser leg.</p>	

Stabiliser system with joystick (rear cabin installation)

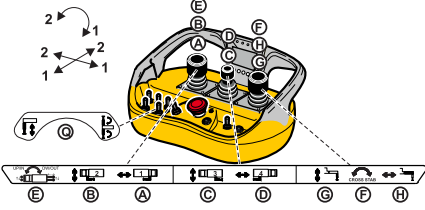
Joystick	Component	Joystick position	Movement			
(A)	Right crane stabiliser		H + A1/A2	out/in (stabiliser extension)		
			G + A1/A2	down (CW) /up (CCW) (stabiliser leg)		
(B)	Left crane stabiliser		H + B1/B2	out/in (stabiliser extension)		
			G + B1/B2	down (CW) /up (CCW) (stabiliser leg)		
(B)	Left crane stabiliser (CroSStab option)		H + B1/B2	out/in (stabiliser extension)		
			G + B1/B2	down (CW) /up (CCW) (stabiliser leg)		
(C)	Left auxiliary stabiliser		H + C1/C2	out/in (stabiliser extension)		
			G + C1/C2	down/up (stabiliser leg)		
(D)	Right auxiliary stabiliser		H + D1/D2	out/in (stabiliser extension)		
			G + D1/D2	down/up (stabiliser leg)		
(E)	Front/rear auxiliary stabilisers [option]		G + E1/E2	out/in <table border="1" data-bbox="860 699 1021 778"> <tr> <td>G in 2 Front</td> </tr> <tr> <td>G in 1 Rear</td> </tr> </table>	G in 2 Front	G in 1 Rear
			G in 2 Front			
G in 1 Rear						
G + E1/E2	down/up <table border="1" data-bbox="860 778 1021 858"> <tr> <td>G in 2 Front</td> </tr> <tr> <td>G in 1 Rear</td> </tr> </table>	G in 2 Front	G in 1 Rear			
G in 2 Front						
G in 1 Rear						
(F)	CroSStab [option]		F + B1	rotation out		
			F + B2	rotation in		
(G)	Stabiliser leg	 	In any position, activates the stabiliser leg movements.			
			Use then the levers from (A) to (E) to operate the desired stabiliser extension in the desired direction 1 or 2.			
(H)	Stabiliser extension		In any position, activates the stabiliser leg movements.			
			Use then the levers from (A) to (E) to operate the desired stabiliser extension in the desired direction 1 or 2.			
			<p>CW: clockwise rotation of stabiliser leg.</p> <p>CCW: counterclockwise rotation of stabiliser leg.</p> <p>Selector (Q): activates/deactivates stabiliser legs movements for tilting or up/setting them to the ground.</p>			

4.11.4. Battery and battery charger

Battery

We recommend that you have a spare controller battery, already charged, to avoid machine downtime. A fully charged battery provides approximately 8 hours of use (at 25°C, 77°F) and the voltage level is approximately 7.2 V. When the battery is about to be out of power an indicator LED (3) on the controller flashes and you hear a beep for three times. Replace the battery within 5 minutes.

Battery charger

Connect the battery charger in a protected environment, preferably in the cab.

1. Connect the battery charger to the power supply using the cable provided.
2. The red LED (1) turns on.
3. Place the battery in the charger.
4. The green LED (2) flashes slowly during recharging and has a steady light when the battery is fully charged.



NOTE

The charging time is approximately 3 hours.

Charging the battery in the controller with the cable

Operating ambient temperature for charging: Battery = 0°C to + 45°C (32°F to 113°F).

When the serial cable is connected, the battery inside the controller will automatically recharge.

1. Push the emergency stop button on the crane and on the controller.
2. Insert the battery.
3. Connect the serial cable to the receiver.
4. Release the emergency stop button located on the crane and on the controller. The controller is ready to use, turn it on if needed.



NOTE

The charging time is approximately 12-14 hours.



CAUTION

- Charge the battery when it is out of power.
- Do not leave the battery without charging it for more than six months.
- Keep the battery and its contacts clean.

**NOTE**

A charged battery is a concentrated energy source. Never store a charged battery in a toolbox or similar where there is a risk of a short circuit because of contact with metal components. Refer to local regulations to discard used batteries.

4.12. SCANRECO HD controller

The SCANRECO HD controller system consists of:

- a controller unit with buttons/selectors and levers
- a receiver
- an emergency cable
- two batteries
- a battery charger and its accessories
- a belt/shoulder strap



The controller normally communicates with the crane through the receiver via radio, but it can also be used with a cable (when the batteries are discharged or when the use of radio frequencies is forbidden).

**CAUTION**

- Use the support strap for safe operation.
- Never leave the remote unattended.
- Disconnect it and store it in a safe place when not in use.

**NOTE**

- For safety reasons, and to minimise battery consumption, the controller automatically turns off after 5 minutes of inactivity.
- To have a correct communication between the controller and the crane system, the controller cannot be more than 100 meters away from the crane without large obstacles in between.

4.12.1. Buttons, selectors and LEDs

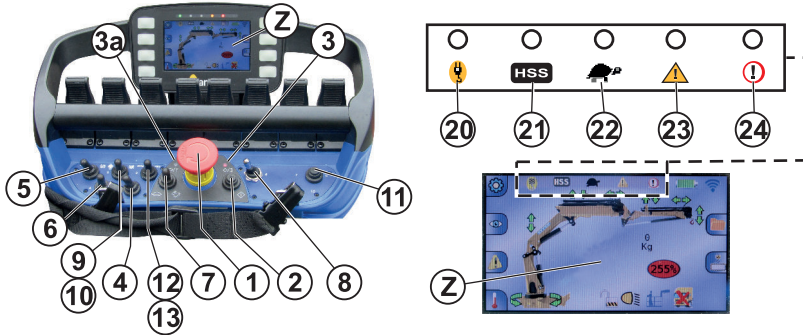









<p>(1) Emergency stop button.</p>	<p>(4) Selector/button for additional equipment [option].</p>	<p>(8) Operation selector mode:</p> <ul style="list-style-type: none"> • Left: CRANE mode (CRANE) • Right: STABILISER SYSTEM mode (STAB) • Centre [option]: (TRUCK WALLS)
<p>(2) Button:</p> <ul style="list-style-type: none"> • Activate the controller. • Reset: push it to reset warnings and alarms. • Horn 	<p>(5) Selector for additional equipment:</p> <ul style="list-style-type: none"> • Left: Hoist • Right: additional equipment 	<p>(9) Truck engine on.</p> <p>(10) Truck engine off.</p>
<p>(3) LED for battery status:</p> <ul style="list-style-type: none"> • On: remote on and the battery is charged. • Flashing: the battery must be replaced. 	<p>(6) Speed selector mode:</p> <ul style="list-style-type: none"> • Left: reduced speed • Right: HSS • Centre: standard speed 	<p>(11) Lights ON/OFF, activation of special features for some models (i.e. 7th or 9th extension with cylinder inside the extension, etc...)</p> <p>(12) Rpm increase.</p>
<p>(3a) LED for radio connection:</p> <ul style="list-style-type: none"> • Flashing: the transmission is bad. 	<p>(7) Speed adjustment:</p> <ul style="list-style-type: none"> • 5 positions based on preset values. 	<p>(13) Rpm decrease.</p>

LEDs

(20)	Fixed green LED: hoist is active. Flashing green LED: hoist is active with automatic rope movement enabled (AWC).	(23)	Fixed yellow: warning due to three possible causes: - max. geometric configuration reached. - close to the max. crane performance limit. - stabiliser not set on to the ground. For further information about the warnings present, go to the menu (F3).
(21)	Fixed yellow LED: HSS is active.		
(22)	Blinking green: automatic max. speed reduction during the operation.	(24)	Fixed red: alarms. For further information about the alarms present, go to the menu (F3).

Buttons for the display (Z)

 	Arrow keys to move inside the display (move between options, select new pages).		ESC button: exit any page.		ENTER button: confirm button.
   		Multifunctional button: push to access data. <ul style="list-style-type: none"> • F1: Settings • F2: Visualisations • F3: Warnings/Alarms • F4: Oil temperature and fan(s) speed 			

Locking the controller:

Push the emergency button.

Unlocking the controller:

1. Release the emergency button.
2. Push and hold for at least two seconds the button (2) to activate the controller. The lights (3) will turn on.

4.12.2. Displays

The display shows information about the operation of the crane, options selected, and errors.



NOTE

You might have different images on your screen depending on the configuration of your crane.



NOTE

- Use the buttons on the sides of the controller display to select the desired icon and to navigate between the different displays (that you access after selecting an icon).
- Use the ENTER button to confirm the selection.
- Use the ESC button to exit the selection.

Stabiliser displays

When you lift up and turn the selector (8) to STAB, the 'STAB ALLOW' or 'STAB RECOVERY ALLOW' display is shown. After a few seconds, the display changes into the stabiliser status displays according to the crane configuration.

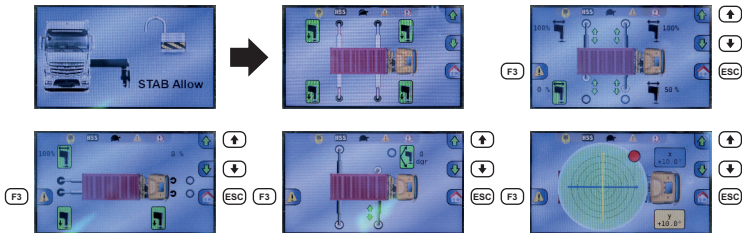

Crane displays

When you lift up and turn the selector (8) to CRANE mode on the controller, the main display is shown. It shows the crane configuration and the movements permitted with the respective arrows.

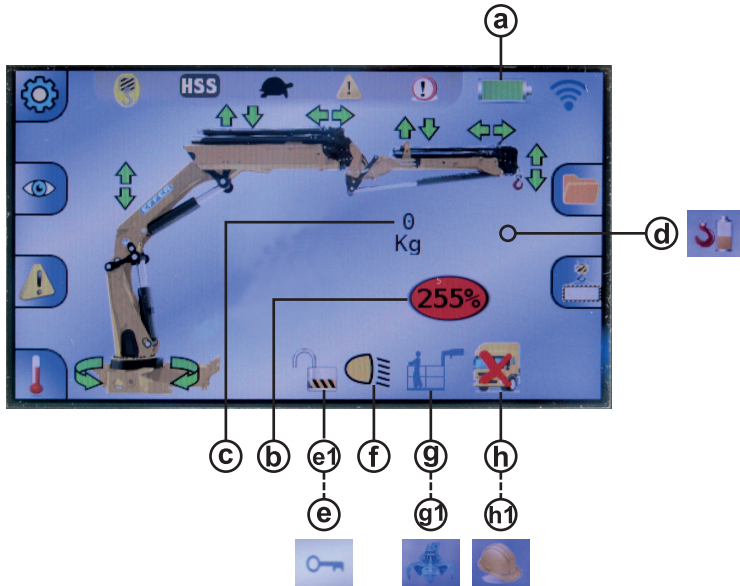



(a)	Battery status	(f)	Lights enabled [option]
(b)	Limit load percentage	(g)	MEWP mode [option]
(c)	Weight detected [option]	(g1)	Rotator/grapple mode [option]
(d)	Radio hook battery status [option]	(h)	Cabin protection enabled [option]
(e)	Not in use	(h1)	Operator protection enabled [option]
(e1)	Progress bypass enabled		

F1: Settings

Set the hoist pulls on the tip of the crane (n. of winch shots/lines) or set the radio hook according to the hook installed.

- Push [F1] to set the hoist pulls on the tip of the crane (n. of winch shots). Change the number with the arrows and confirm with the ENTER button.

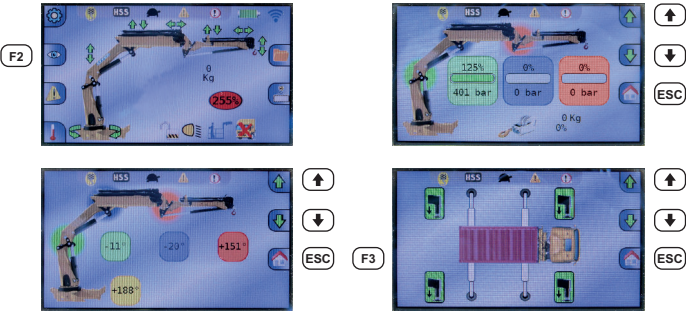
- Push [F2], [F3] or [F4] to set the radio hook according to the hook installed. Confirm the selection with the ENTER button.

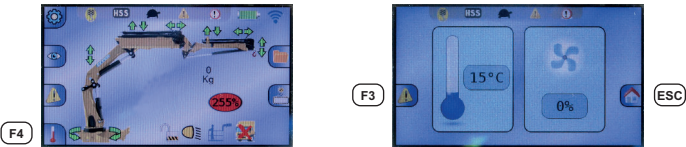
<p>F2: Visualisations</p>	<p>View all the information related with the crane and stabiliser legs status.</p>  <ul style="list-style-type: none"> - Actual percentage of the max. lifting pressure permitted. - Pressure on the lifting cylinders. - Angles of the lifting booms. Position of the column and the boom system. - If a 2nd JIB is applied to the JIB, on pressing the down arrow button only the information related to the 2nd JIB will be displayed. - Hoist weight lifted. - Stabiliser legs set or not set on to the ground. - Push [F3] to go directly to the warning/alarms display.
<p>F3: Warnings/ Alarms</p>	<p>View all the warnings and alarms status.</p> 
<p>F4: Oil temperature/ Fan(s)</p>	<p>View the oil temperature and fan(s) speed. Push [F3] to go directly to the warning/alarms display.</p> 

Display when an emergency button is pushed

If you push an emergency stop button, the display will show an appropriate message.

If you push the emergency stop button on the controller, the controller display will turn off.



Depending on the control station where you push the button, you will see a different image on the display (Box A (main panel), MEWP). If the crane is on stand-by, push and release one of the emergency stop buttons for operation.

Communication error

During the crane operation, this page may be displayed to indicate the loss of radio communication between the transmitter and the receiver of the controller















4.12.3. Standard functions and symbols



NOTE





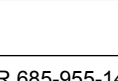

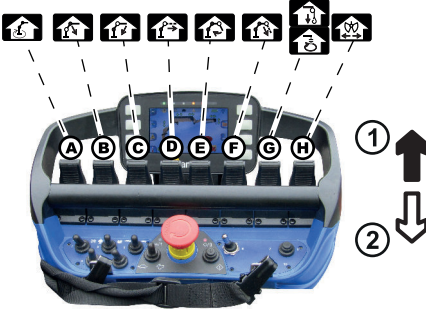

The function corresponding to each lever depends on the configuration of the specific crane. The following tables are examples.

Crane

Lever/ Joystick	Component	Lever/Joystick position	Movement
(A)	Slewing		1 clockwise slewing
			2 counterclockwise slewing
(B)	1st boom		1 down (folding)
			2 up (unfolding)
(C)	2nd boom		1 down (folding)
			2 up (unfolding)
(D)	Hydraulic extensions		1 out (extracting boom extensions)
			2 in (retracting boom extensions)
(E)	JIB cylinder [option]		1 down (folding)
			2 up (unfolding)
(F)	JIB extensions [option]		1 out (extracting JIB extensions)
			2 in (retracting JIB extensions)
(G)	Hoist [option]		1 rope down
			2 rope up
	Rotator [option]		1 clockwise rotation
			2 counterclockwise rotation

Lever/ Joystick	Component	Lever/Joystick position	Movement
(H)	Grapple [option]		1 grapple (opening/closing) 2 grapple (opening/closing)
			

Stabiliser system (rear cabin installation)

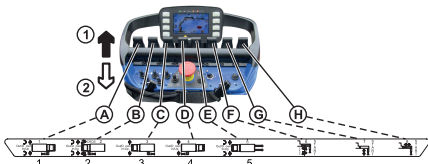
Lever/ Joystick	Component	Lever/Joystick position	Movement			
(A)	Right crane stabiliser		H + A1/A2	out/in (stabiliser extension)		
			G + A1/A2	down (CW) / up (CCW) (stabiliser leg)		
(B)	Left crane stabiliser		H + B1/B2	out/in (stabiliser extension)		
			G + B1/B2	down (CW) / up (CCW) (stabiliser leg)		
(B)	Left crane stabiliser (CroSStab option)		H + B1/B2	out/in (stabiliser extension)		
			G + B1/B2	down (CW) / up (CCW) (stabiliser leg)		
(C)	Left auxiliary stabiliser		H + C1/C2	out/in (stabiliser extension)		
			G + C1/C2	down/up (stabiliser leg)		
(D)	Right auxiliary stabiliser		H + D1/D2	out/in (stabiliser extension)		
			G + D1/D2	down/up (stabiliser leg)		
(E)	Front/rear auxiliary stabilisers [option]		H + E1/E2	out/in <table border="1" style="display: inline-table; vertical-align: middle;"> <tr> <td>H in 1 Front</td> </tr> <tr> <td>H in 2 Rear</td> </tr> </table>	H in 1 Front	H in 2 Rear
			H in 1 Front			
H in 2 Rear						
G + E1/E2	down/up <table border="1" style="display: inline-table; vertical-align: middle;"> <tr> <td>G in 1 Front</td> </tr> <tr> <td>G in 2 Rear</td> </tr> </table>	G in 1 Front	G in 2 Rear			
G in 1 Front						
G in 2 Rear						
(F)	CroSStab [option]		F + B1	rotation out		
			F + B2	rotation in		
(G)	Stabiliser leg		In position 1 or 2, activates the stabiliser leg movements. Use then the levers from (A) to (E) to operate the desired stabiliser extension in the desired direction 1 or 2.			
(H)	Stabiliser extension		In position 1 or 2, activates the stabiliser extension movements. Use then the levers from (A) to (E) to operate the desired stabiliser extension in the desired direction 1 or 2.			
			<p>CW: clockwise rotation of stabiliser leg.</p> <p>CCW: counterclockwise rotation of stabiliser leg.</p>			

Stabiliser system (rear body installation)

Lever/ Joystick	Component	Lever/Joystick position	Movement				
(A)	Left crane stabiliser		H + A1/A2	out/in (stabiliser extension)			
			G + A1/A2	down (CW) /up (CCW) (stabiliser leg)			
(B)	Right crane stabiliser		H + B1/B2	out/in (stabiliser extension)			
			G + B1/B2	down (CW) /up (CCW) (stabiliser leg)			
(B)	Right crane stabiliser (CroSStab option)		H + B1/B2	out/in (stabiliser extension)			
			G + B1/B2	down (CW) /up (CCW) (stabiliser leg)			
(C)	Right auxiliary stabiliser		H + C1/C2	out/in (stabiliser extension)			
			G + C1/C2	down/up (stabiliser leg)			
(D)	Left auxiliary stabiliser		H + D1/D2	out/in (stabiliser extension)			
			G + D1/D2	down/up (stabiliser leg)			
(E)	Front/rear auxiliary stabilisers [option]		H + E1/E2	out/in	H in 1 Front H in 2 Rear		
				G + E1/E2	down/up	G in 1 Front G in 2 Rear	
			(F)		CroSStab [option]		F + B1
				F + B2			rotation in
(G)	Stabiliser leg		In position 1 or 2, activates the stabiliser leg movements. Use then the levers from (A) to (E) to operate the desired stabiliser extension in the desired direction 1 or 2.				
(H)	Stabiliser extension		In position 1 or 2, activates the stabiliser extension movements. Use then the levers from (A) to (E) to operate the desired stabiliser extension in the desired direction 1 or 2.				
			<p>CW: clockwise rotation of stabiliser leg.</p> <p>CCW: counterclockwise rotation of stabiliser leg.</p>				

4.12.4. Battery and battery charger

Battery

We recommend that you have a spare controller battery, already charged, to avoid machine downtime. A fully charged battery provides approximately 8 hours of use (at 25°C, 77°F) and the voltage level is approximately 7.2 V. When the battery is about to be out of power an indicator LED (3) on the controller flashes and you hear a beep for three times. Replace the battery within 5 minutes.

Battery charger

Connect the battery charger in a protected environment, preferably in the cab.

1. Connect the battery charger to the power supply using the cable provided.
2. The red LED (1) turns on.
3. Place the battery in the charger.
4. The green LED (2) flashes slowly during recharging and has a steady light when the battery is fully charged.

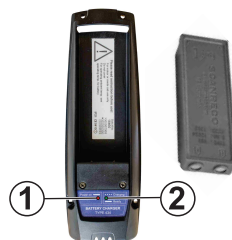

NOTE

The charging time is approximately 3 hours.

Charging the battery in the controller with the cable

Operating ambient temperature for charging: Battery = 0°C to + 45°C (32°F to 113°F).

When the serial cable is connected, the battery inside the controller will automatically recharge.

1. Push the emergency stop button on the crane and on the controller.
2. Insert the battery.
3. Connect the serial cable to the receiver.
4. Release the emergency stop button located on the crane and on the controller. The controller is ready to use, turn it on if needed.



NOTE

The charging time is approximately 12-14 hours.



CAUTION

- Charge the battery when it is out of power.
- Do not leave the battery without charging it for more than six months.
- Keep the battery and its contacts clean.

**NOTE**

A charged battery is a concentrated energy source. Never store a charged battery in a toolbox or similar where there is a risk of a short circuit because of contact with metal components. Refer to local regulations to discard used batteries.

4.13. High seat [option]

The high seat is on the upper part of the column. Use the ladder to access the high seat.

**DANGER**

When you go into or out from the control station, use only handles and supports on the crane that were specifically made to help you as the operator to go into or out from the control station.

**WARNING**

- Do not exceed the maximum weight (150 kg).
- Always stabilise the vehicle with the stabiliser system before going into the high seat.
- Always unfold the boom system without slewing the crane before going into the high seat.
- Use all the safety devices available in the high seat before operating the crane.
- For safety reasons, it is necessary to sit down on the seat to operate the controls.
- Always push the stop button on the controller before leaving the high seat.

**How to adjust the controller on the high seat**

1. Put the controller in its holder (1).
2. Adjust and lock the position of the controller with the locking devices (2), (3), and (4).

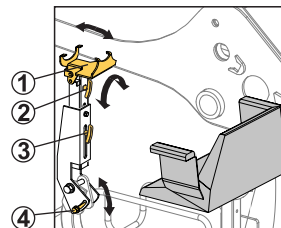

5. Starting crane operation

5.1. Starting operations

Put the vehicle on a flat, firm, and stable surface.



IMPORTANT

To avoid sudden movements of the vehicle and damages to the stabiliser system, the vehicle must be completely levelled in any direction ($\alpha=0^\circ$) with the crane in transport position and the boom system folded before starting any operation.

To determine the inclination of the truck, check the spirit level on the crane. When the bubble is in the middle of the gauge, the crane is in horizontal position.

The vehicle inclination (α) during crane operation must **not be more than 3°** when working with the boom system below 30° .

The vehicle inclination (α) during crane operation must **not be between 0° and 1°** when working with the boom system above 30° .

If these values are exceeded, unintentional crane movements can occur.

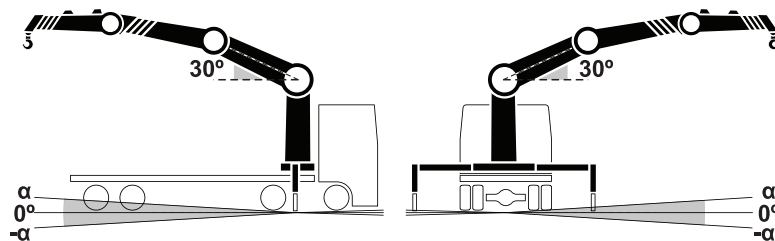
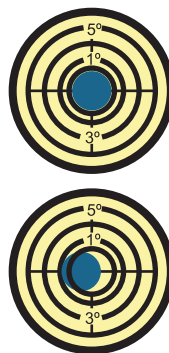

CAUTION

- Remember to operate the crane into and out of the transport position with the vehicle completely levelled.
- Activate the parking brake and place chocks under the wheels to prevent vehicle movement.

Engage the PTO

1. Activate the parking brake and place chocks under the wheels to prevent vehicle movement.
2. Engage the PTO (Power Take Off) and bring the vehicle engine to the correct rpm.



NOTE

- Rpm too high: the oil in the hydraulic system might overheat.
- Rpm too low: during crane operation, the vehicle engine could stall.
- The maximum rpm may depend upon a governor on your PTO combination.



CAUTION

Close the driver's cab to prevent access to unauthorised persons.

Start the control system

The operating levers must be in neutral position before you start.

The control system starts automatically when the PTO is engaged. If this feature is not activated, push the ON/OFF button  on the User Interface **(A)** and activate the control system.

- The light on the reset LED **(C)** will flash while the system is checking itself and stop flashing when the system is ready to start the operation.
- The green and yellow lights will blink on the display panel.
- The green light will blink on the column lamp.

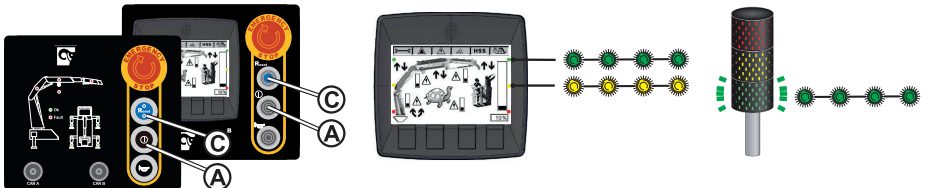

- If the system is equipped with the stabiliser LED lights, these will also come on.



Start the controller

Fasten the controller to a waist belt, or shoulder-/neck strap, in the most comfortable operating position. The emergency stop button should be on the right-hand side.

SCANRECO - SCANRECO HD

1. To activate the controller, pull out the emergency stop button by turning it clockwise.
2. Push button (1) 'On-Off/Reset'.

The LED (2) becomes steady when the controller is active and LED (3) flashing green indicates a correct radio communication between the transmitter and the receiver.

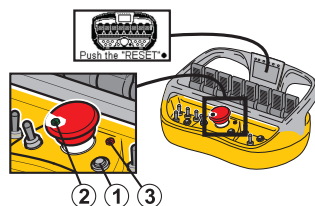

NOTE

When all the emergency buttons are released, a message pops up on the screen to 'PRESS RESET' or 'PUSH THE RESET'.

3. Push button (1) again.



NOTE

When the reset button is pressed, the buzzer emits a short sound and all the signal lamps light up for a few seconds.

5.2. Set the stabiliser system

To ensure the maximum stability of the vehicle, all the stabiliser extensions and legs must be fully extended and set to the ground without lifting the wheels from the ground.

- **Cranes with Progress:**

Progress is a system based on four stability areas (Right, Left, Front, Rear) where the lifting capacity and the width of the areas change in relation to how much the stabiliser extensions are extended and the installation.

When the stabiliser extensions are not fully extended, the lifting capacity is optimised by the Progress feature to ensure the maximum stability of the vehicle.

On a crane with Progress, the position of the crane stabiliser extensions is detected proportionally by the Progress system to calculate the stability. But the position of the auxiliary stabiliser extensions is not detected proportionally to calculate the stability, but only some preset values are detected.

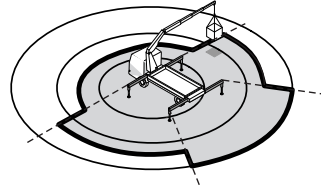

- **Cranes with Progress and SENSE:**

Progress and SENSE is a system that calculates the stability in each point of the working area. It changes the performance in relation to how much the stabiliser extensions are extended and the installation.

When the stabiliser extensions are not fully extended, the lifting capacity is optimised point by point by the Progress and SENSE feature to ensure the maximum stability of the vehicle.

On a crane with Progress and SENSE, the position of both, crane stabiliser extensions and auxiliary stabiliser extensions, is detected proportionally by the feature SENSE to calculate the stability.

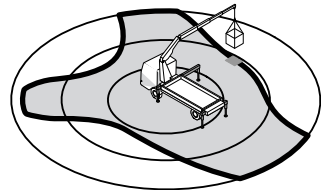

WARNING

If your vehicle has a front and/or a rear auxiliary stabiliser system [option], with one or two legs, make sure that all legs are correctly set to the ground before you start operating the crane to get maximum performance.

5.2.1. Stabiliser system and ground conditions

Always:

- Make sure that the ground can support the load that the stabiliser leg imposes on the ground. (*)
- Make sure that the ground is not undermined.
- If the ground is not sufficiently compact and resistant, add an extra support plate under the stabiliser legs.
- Use the extra support plates that are large and firm enough for your crane model.

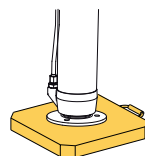

The maximum permitted ground inclination under the stabiliser leg plate is 5°.



(*) The maximum load that the stabiliser leg can apply to the ground is:

Crane model	Max. reaction (R _{max}) [daN]	Pressure (*1) [MPa]	Plate area [m ²]	Standard plate dimensions (*2) (*3) [m]
175.2	7100	3.13	Disk: 0.0227	NOT NECESSARY
215	11900	3.78	Disk: 0.0314	
265	14800	1.65	Disk: 0.09	0.3 x 0.3
315	14800	1.65		
395	19000	2.11		
525	18945	2.10		
685	23000	2.55		
955	25500	2.83		
1000	32000	3.55		
1405	28000	3.11		
1855	33500	3.72		
2055	36500	1.01		
2255	42000	1.17		
2655	48000	3.1	Disk: 0.15	NOT NECESSARY

(*1) Pressure on the ground surface.

(*2) Plate dimensions according to the standard EN 12999-2011 (P<4 MPa). Standard supply.

(*3) The same plates for crane stabiliser legs must be provided for auxiliary stabiliser legs.



NOTE

- For crane models which the pressure applied on the ground by the stabiliser leg plates is more than 4Mpa (40kg/cm²), extra support plates (only CE cranes) are provided as standard.
- The load plate shows the maximum force that the stabiliser legs can apply to the ground.

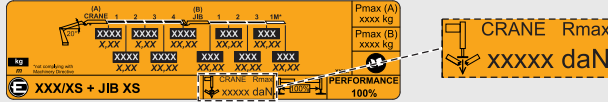

- There is a plate on the auxiliary stabiliser legs which shows the maximum force that the stabiliser legs can apply to the ground.

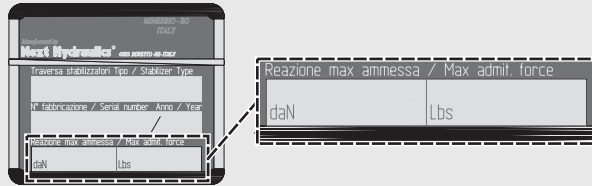

DANGER



Verify that the extra support plates do not bend or sink into the ground.

Do not lower the stabiliser legs on the edge of an embankment, soft ground, hollows, etc... Lower the stabiliser legs only onto a flat, firm, and stable surface.



WARNING

If a stabiliser leg detaches from the extra support plate during operation, you must verify that the leg goes back correctly to the centre of the support plate. If not, there is a risk of tilting the vehicle or damaging the stabiliser legs.

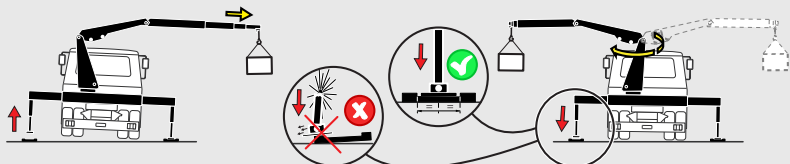



NOTE

During crane operation, if two stabiliser legs detach from the ground, the Progress system stops the crane movements automatically. Retracting the boom extensions is the only movement allowed until the stabiliser legs are properly set on the ground again.

5.2.2. Activate the stabiliser system

Remote-controlled stabiliser system:

1. Lift up and turn the selector (V) to 'STAB' on the controller.
The green and yellow lights on the display panel and the column lamp will blink when the stabiliser system operation is active.

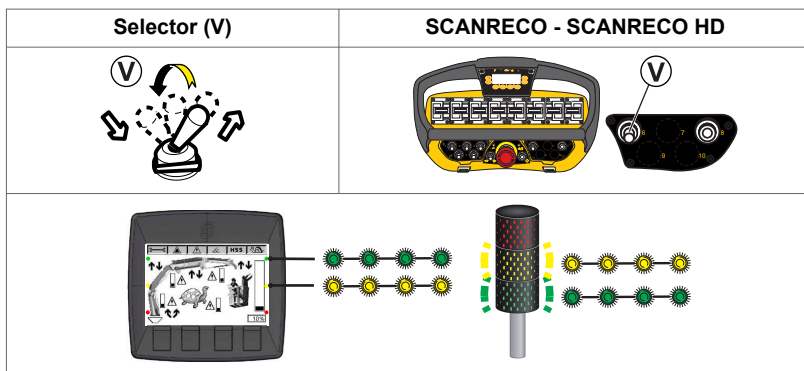

2. Move to the side of the crane where you want to start the operation.
3. Make sure that you have full view of the stabiliser system, and push the timed button that is on the same side of each stabiliser extension/leg.



NOTE

The button will light up during operation of the stabiliser system on that side. If the time expires before you finish the operation, push it again.

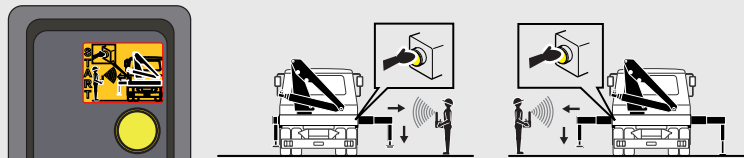



WARNING

- Do not let another person push the timed button.
- You must always have a clear view of the stabiliser system when operating.
- Do not push the timed button on one side of the vehicle and then move to the opposite side and move the stabilisers.

4. Activate the related levers on the controller.



NOTE

To avoid that the stabilisers move accidentally, you can only operate them with a double-action control:

- Push and hold the related lever to activate the stabiliser function.
- Pull the lever for the stabiliser extension/leg movement.

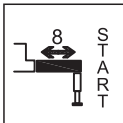
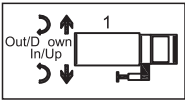
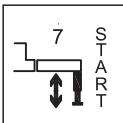
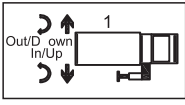
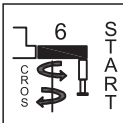
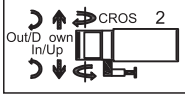
	SCANRECO - SCANRECO HD	
Stabiliser extensions		
Stabiliser legs		
Rotating stabiliser (CroSStab)		



NOTE

With Progress system:

- You can operate the stabiliser system in all directions only if the message '**STAB ALLOW**' is visible on the controller display.
- You can operate the stabiliser leg downwards if the message '**STAB RECOVERY ALLOW**' is visible on the controller display.
- You cannot operate the stabiliser system if the message '**STAB LOCK**' is visible on the controller display.

5.2.3. Extend the stabiliser extensions



WARNING

If your crane has tiltable stabiliser legs, always operate the tiltable stabiliser leg against the stabiliser extension before extending the stabiliser extension.

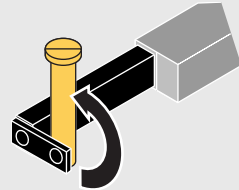

The procedure of setting the crane and auxiliary [option] stabiliser extensions differs depending on the type of stabiliser extensions. Repeat the instructions for the stabiliser extension(s) on the other side of the vehicle.

Hydraulically controlled stabiliser extensions

1. Move the stabiliser locking device **(A)** up, put reference **(B)** on pin **(C)** as shown in the picture.

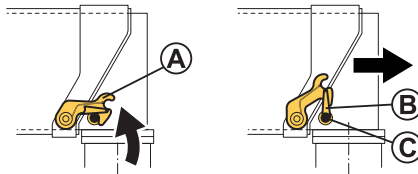

2. Lift up and move the selector **(V)** to 'STAB' mode on the controller.
3. Push the timed button that is on the same side.
4. Extend the stabiliser extensions with the levers on the controller depending on your crane configuration.



DANGER

Do not stand in front of the hydraulically operated stabiliser extensions when you are operating them!

5. For a complete extraction, stop when you see the coloured strip on the extension.



CAUTION

- If you have multi-stage stabiliser extensions, verify that the larger section tube is completely out (marked by a yellow reference) before extracting a smaller section. If not, repeat the extraction.
- If you retract the stabiliser extensions to change the position of the stabiliser legs, it may be necessary to retract the stabiliser extensions completely to keep the sequence, larger extensions completely extended before the smaller ones.

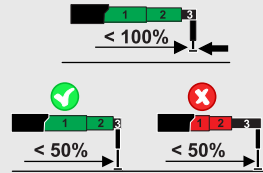

CroSStab stabiliser system

1. Unlock the rotation stabiliser locking device (**E**).
2. Lift up and move the selector (**V**) to 'STAB' mode on the controller.
3. Push the timed button that is on the same side.
4. Rotate the stabiliser extension (**S**) to the desired angle position.

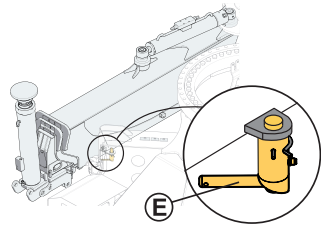

CAUTION

- Do not extend the stabiliser extension (**S**) until you have completed the stabiliser extension rotation.
- During the stabiliser extension rotation, you must stay in a safe area and make sure that there are no other persons within the rotation area.

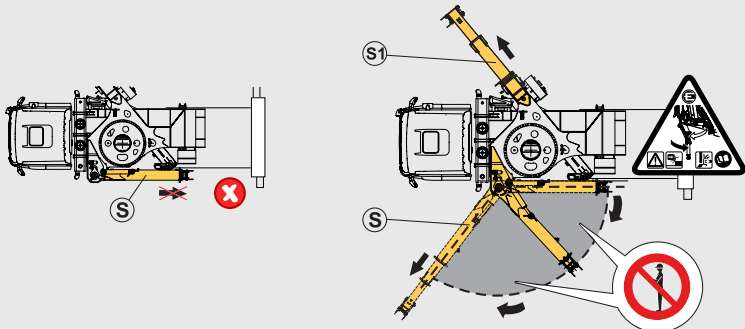

5. Move the stabiliser locking device (A) up, put reference (B) on pin (C) as shown in the picture.

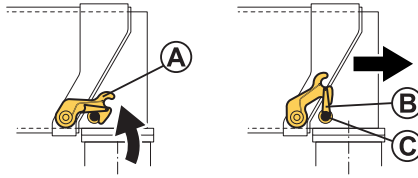

6. Extend the stabiliser extensions (S) and (S1) with the levers on the controller depending on your crane configuration.



DANGER

Do not stand in front of the hydraulically operated stabiliser extensions when you are operating them!

7. For a complete extraction, stop when you see the coloured strip on the extension.



CAUTION

- If you have multi-stage stabiliser extensions, verify that the larger section is completely out (marked by a yellow reference) before extracting a smaller section. If not, repeat the extraction.
- If you retract the stabiliser extensions to change the position of the stabiliser legs, it may be necessary to retract the stabiliser extensions completely to keep the sequence, larger extensions completely extended before the smaller ones.

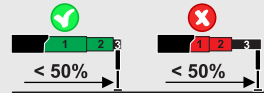
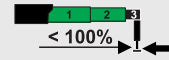



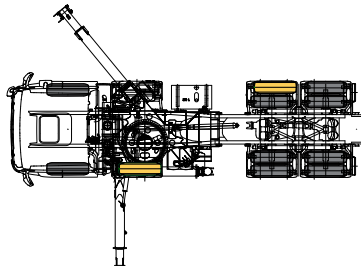

8. Make sure that chocks are placed in the right position for the CroSStab stabiliser system. Put four chocks under the wheels as shown in the figure (2 chocks under the wheel of the stabiliser rotation and 2 chocks under the wheel on the axle on the opposite side).

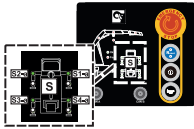

Stabiliser extensions status:

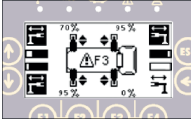
The percentages of the stabiliser extension extended are shown in the Display panel and on the controllers.

User Interface with LEDs	Display panel	SCANRECO	SCANRECO HD
			

5.2.4. Set the stabiliser legs

The procedure of setting the crane and the auxiliary [option] stabiliser system differs depending on the type of stabiliser system. Repeat the instructions for the stabiliser leg(s) on the other side of the vehicle.



WARNING

Take care not to lower the stabiliser leg onto your foot.



DANGER

Always ensure that the stabiliser legs and stabiliser extensions are in working position and securely locked.



NOTE

At the end of the operation, do a check of the levelling of the vehicle with the spirit level. If necessary, adjust the stabiliser system.

Stabiliser legs status:

- Stabiliser legs not set on the ground (1).
- Stabiliser legs set on the ground (2).

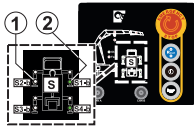
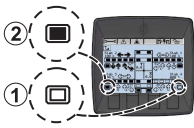
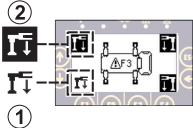
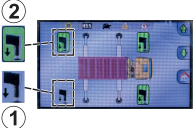
User Interface with LEDs	Display panel	SCANRECO	SCANRECO HD
			

Put the extra support plates

- Put the extra support plates under the stabiliser leg plates (if necessary).

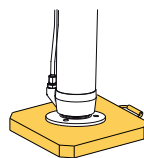

DANGER

Do a check that the support plates do not bend or sink into the ground!

Non-tiltable stabiliser legs

- Make sure that the stabiliser extensions are extended.
- Put the extra support plate (1) onto the ground (if necessary).
- Operate the stabiliser leg downwards until it is set to the ground.

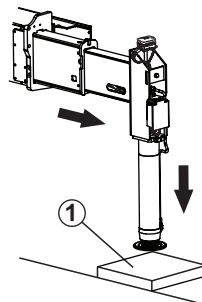

Hydraulically-controlled tiltable stabiliser legs (180°)



DANGER

Stay away from the tilting area of the stabiliser leg.

When the leg turns, there is a risk of injury.

Always keep your hands away from the moving parts during this operation.

Make sure the tilting mechanism remains unlocked during the complete tilting.

1. Make sure that the stabiliser extension is extended and you can rotate the stabiliser leg freely.
2. Tilt the stabiliser leg:
 - a. Turn the lever **(A)** vertically to activate the tilting movement.
 - b. Operate the stabiliser leg against the stabiliser extension.
 - c. Remove the cotter pin and pin **(B)**.
3. Turn the leg from the controller. Make sure that you have full control of the movement to avoid risk of injury.
4. Insert the pin **(B)** again in the tilting mechanism when reaching the working position. Lock the pin with the cotter pin.
5. Move the lever **(A)** to the horizontal position.
6. Put the extra support plate (if necessary) onto the ground.
7. Set the stabiliser leg on the ground.
8. Turn the lever **(A)** vertically.

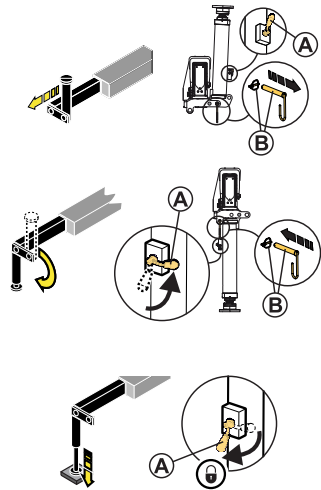

WARNING

- Always do a check that the stabiliser legs and the stabiliser extensions are in the correct position and that the tilting mechanism is locked in the working position.
- Remember that the valve lever of the stabiliser leg has two positions:
 - In the horizontal position **(A)**, it activates the stabiliser leg up/down movements.
 - In the vertical position **(B)**, it activates the stabiliser leg tilting movement.

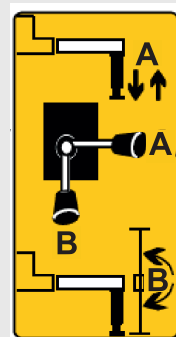

5.3. Operate the boom system out of transport position



WARNING

- A crane with interchangeable equipment and/or optional crane components can differ from the operations described in this section. For this reason, study the operating instructions for any interchangeable equipment and/or optional crane components carefully.
- Always make sure that the stabiliser extensions and legs are in working position and securely locked before operating the boom system out of the parking position. Otherwise, the message 'CRANE LOCK' will appear on the controller display.
- We recommend that you do these operations slowly or use the option for reduced speed.

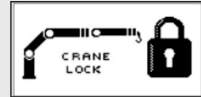

DANGER

- With remote-controlled cranes, stay in a safe area while the boom system is moving.
- If the crane is equipped with a high seat with the controller, operate the boom system out of transport position from the ground.



5.3.1. Boom deployment assistance with Progress

Progress prevents the operator to move the 2nd boom and extensions in the wrong direction when operating the crane into or out of transport position.

• Operating the crane to transport position:

When the angle β is $>135^\circ$ between the horizontal and 2nd boom, the system does not allow to raise the 2nd boom or to move extensions out/in.

• Operating the crane out of transport position:

When the angle β is $<135^\circ$ between the horizontal and 2nd boom, the 2nd boom and extensions can move without any restrictions.

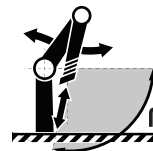
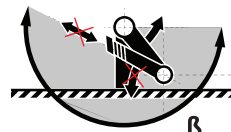

5.3.2. Operate the boom system

1. Remove the safety pin that locks the 1st boom (if installed).
2. Activate the controller by lifting up and moving the selector (V) to 'CRANE' mode.

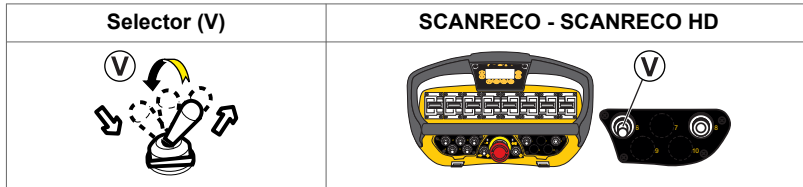

3. Operate the 2nd boom against the 1st boom (1) to raise it from its rest position on the column.
4. Retract the extensions (2).



CAUTION

Do these operations slowly to prevent damage to the crane.

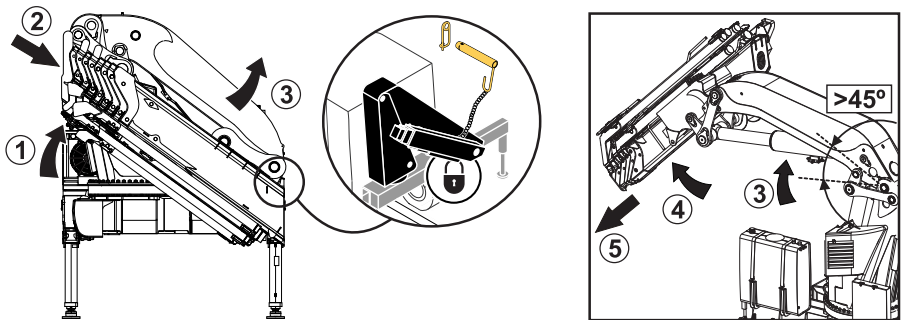

5. Raise the 1st boom (3) of about 45°.
6. Raise the 2nd boom (4) until you have enough space to safely open the JIB (if installed).
7. Slew the crane to the working position.
8. If needed, extend the crane boom extensions (5).

6. During operation

6.1. Features

The control system provides a large number of features. Certain features are standard, others are options.

6.1.1. MAX boom elevation (tipping)

This feature allows the 2nd boom and the JIB to reach a greater alignment in relation to the previous boom or extension.

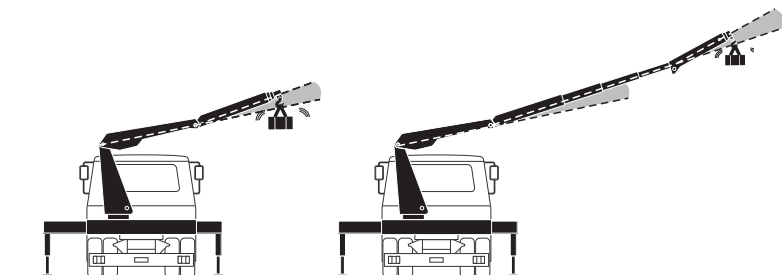

- **2nd boom tipping check**

The 2nd boom can tip in relation to the 1st boom. When the 2nd boom goes beyond a 30° angle, the system emits a single sound. The movements blocked by the load limiter vary according to the 2nd boom angle.

If the 1st boom is moved to the max vertical position when the 2nd boom is in tipping position, the system blocks the lifting movement when the 2nd boom reaches a verticality of approximately 80° (max verticality).

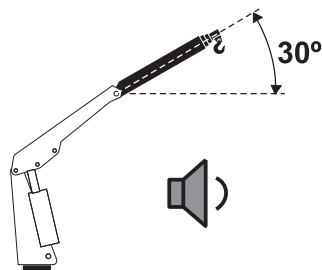

• JIB tipping check

The JIB can tip in relation to the 2nd boom. When the JIB goes beyond the alignment with the 2nd boom, the system emits a double sound, both raising and lowering the JIB.

When the JIB is in tipping position, if the crane booms are in the max. verticality position, the system blocks the lifting movements when the JIB reaches a 50° verticality (Max. verticality allowed under the JIB position). The displays show the crane movements blocked.

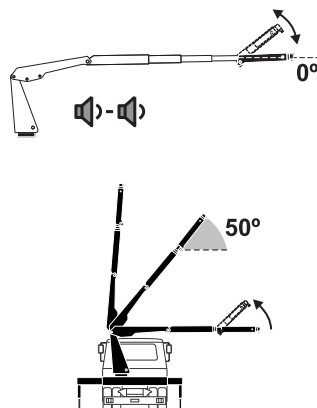

NOTE

The configuration with the basic crane in completely vertical position is possible only if the JIB is not in tipping position.

6.1.2. MAX speed limitation (automatic slow-down)

This feature is managed by Progress and keeps the operation safe and efficient in one or more of the following conditions.

• Safe operation with the crane in vertical position (2nd boom over 50° till the max verticality) when:

- working with the crane boom system in vertical position to prevent sudden movements that could damage the load and the crane.
- operating a quick lowering movement starting from the vertical boom system position (the load could hit the boom and the descent could become not easy to control, compromising the load stability).
- operating quick slewing movements with the boom extensions fully extended in vertical positions.
- extending quickly the boom extensions.
- having lateral deflection on the boom system over 70° more than 3°.

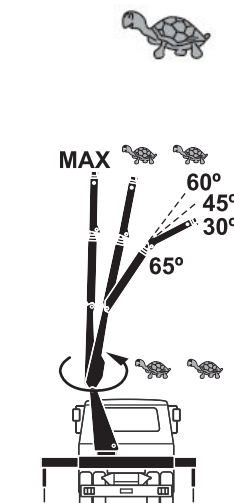



NOTE

The lateral deflection sensor (if installed) blocks the crane movements causing side swaying on the last boom extension, and the warning message 'B4 010' appears on the controller display. To solve it, operate the crane to the transport position and level the vehicle completely. If the error does not disappear, go to an authorised service workshop.



NOTE

When working in vertical position, the load swinging can generate a not-real overload detection. In these cases, push the reset button to continue with crane operations.

- **When heavy loads are applied to the crane** to avoid over-pressures.
- **With flow sharing** to allow simultaneous crane movements.
- **When there is a need to limit the maximum crane hook speed to prevent damage to the crane or the load.**
- **When working with the “MAX boom elevation”** to avoid overturning the vehicle. The 2nd boom can go against the 1st boom, when the 2nd boom goes over a 30° angle, you will have different warnings on the crane.

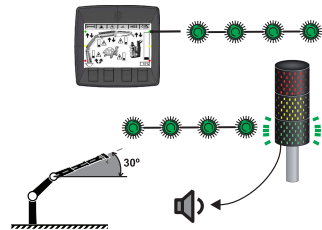

WARNING

When the conditions that activate the automatic slow-down are no longer detected, the crane speed automatically increases.



NOTE

When the maximum speed is reduced by Progress for safety reasons (despite any activated feature), the green light blinks.



6.1.3. Snail feature

This feature reduces the speed of your crane when you need precision or small movements.



NOTE

- The display panel on the User Interface allows the operator to select a specific speed for each movement of this feature.
- The User Interface with LEDs does not allow the operator to select a specific speed for each movement of this feature. Contact an authorised service workshop for more information.

Speed setting on the display panel

1. Go to the 'Crane settings' menu on the display panel and select 'Utilities', 'Speed setting' and 'Snail parameters'.
2. Move the arrows buttons to select the parameter you need to change. The field selected blinks.
3. Push the 'SEL' button. The new screen shows the current parameter value.
4. Increase or decrease the percentage of the speed with the arrows buttons.
5. Push the 'SEL' button to confirm the new parameter value.
6. If needed, repeat this procedure to change other parameter values.

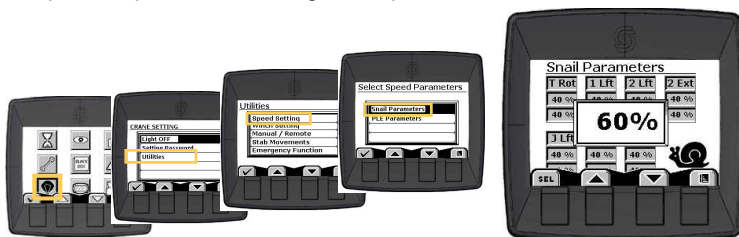

6.1.4. HSS High Speed System [option]

This feature increases the boom extension speed of the crane.

To achieve the maximum pushing power and reach the lifting load capacity shown in the load diagram, deactivate HSS.

Active and deactivate this feature from the selector on your controller.

6.1.5. Controlling the crane speed with the controller SCANRECO - SCANRECO HD

When you turn the speed selector, all levers must be in neutral position.

NOTE

The crane speed always depends on the crane functions you are using and how many crane functions you operate at the same time.

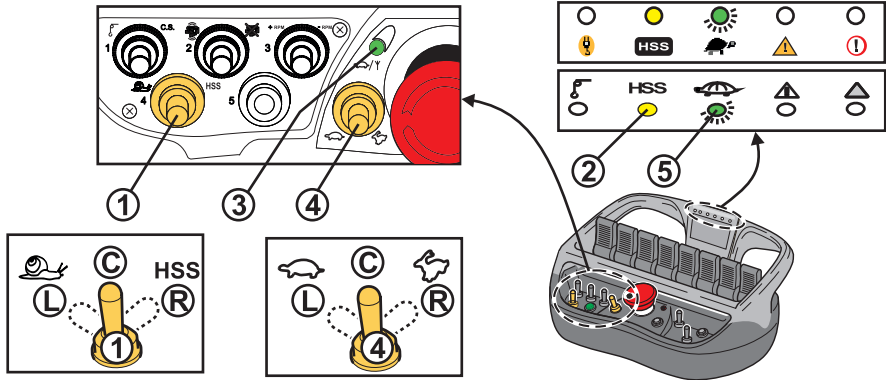

- To activate the feature HSS, turn the selector (1) to the HSS symbol (R). The yellow light (2) is on when the feature is active.
- To activate the snail feature and reduce the speed, turn the selector (1) to the snail (L). The green light (3) blinks indicating the set of selected snail speed (refer to the note below).

NOTE

With the snail feature activated, move the selector (4) to the left for a maximum of five times to adjust the crane's reduced speed. These five reductions are from 100% to 60%, 50%, 40%, 30% and 20%.

Green LED (3)	Indication
Not lit	0 to 100% reduced speed
1 blink every three seconds	0 to 60% speed
2 blink every three seconds	0 to 50% speed
3 blink every three seconds	0 to 40% speed
4 blink every three seconds	0 to 30% speed
5 blink every three seconds	0 to 20% speed

WARNING

- If you turn the selector to the (R) position, the crane returns to the reduced speed (100%).
- If you push the emergency stop button on the controller, the last speed selected will be active when you start the controller again.

- To deactivate both features, turn the selector (1) to centre position (C).

**NOTE**

When the maximum speed is reduced by Progress for safety reasons (despite any activated feature), the green light blinks (5).

6.1.6. Pump flow sharing

When operating several functions simultaneously, the pump flow may not be sufficient. The pump flow sharing system, controlled by Progress, will take over, reducing the speed of all operated functions. Uncontrolled movements are thus avoided, and smooth simultaneous operation is achieved. Progress adjust the quantity of the oil that needs to be reserved for each single function.

6.1.7. Automatic oil temperature detection

The Progress system detects the oil temperature with a sensor on the oil cooler.

- When the oil reaches 40°C, the oil cooler starts running at the minimum speed that gradually increases up to the maximum speed when the oil reaches 60°C.
- When the oil reaches 70°C, the system generates a warning 'WN 017 Wrn – OilTempHigt'.
- When the oil reaches 80°C, the system gives a visual warning 'WN 027 Wrn – OilTempTooHi' and a sound warning, but it does not stop the crane.

**NOTE**

Green light on the display panel blinks when the oil cooler is activated.

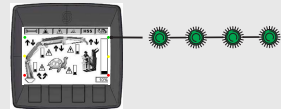
**6.1.8. Radio hook [option]**

A device on the hook detects the weight of the load attached to the hook and shows the value in Kg on its display and the controller display. On the controller display, the value is shown as an alternative to the value detected on the hoist if the hoist is not in use.

**NOTE**

The safety calculations of Progress for the moment limiter do not include this value. Also, the value detected cannot be used for commercial purposes.

To recharge the device that transmits the detected weight, connect it to the cigarette lighter socket in the truck cabin.

6.1.9. VS Virtual Shield [option]

This feature protects the truck cabin from the movements of the boom system when operating the crane.

It is integrated in the control system, and it uses a sensor on the slewing system and boom angle sensors to detect the position of the crane.

It creates a virtual cage around the area where the truck cabin stands.

This feature is active only if an Effer authorised workshop enables it.

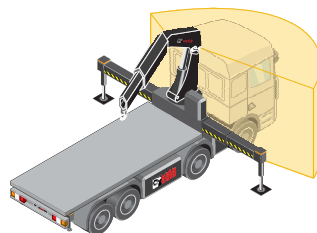

6.1.10. OVS Operator Virtual Shield [option]

OPS is a system that protects the operator from the movements of the boom system when operating the crane.

It is integrated in the control system, and it uses a sensor on the slewing system and boom angle sensors to detect the position of the crane.

It creates a protected area where the boom system cannot operate.

This feature is active only if an Effer authorised workshop enables it.

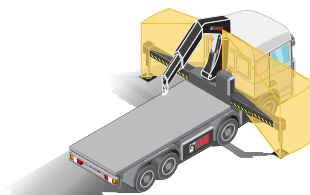

6.1.11. Integration of a removable ballast and/or counterweight

The Progress system allows the use of a ballast (see figure **A**) and, with SENSE [option], also of a removable counterweight (see figure **B**).

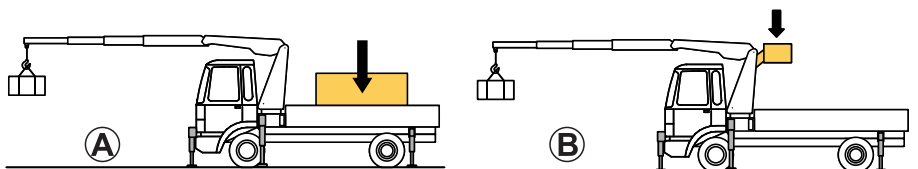

To tell Progress that you are using a ballast/counterweight, activate the detection with the related selector. When the system recognises correctly the ballast/counterweight, you will hear a double beep sound.

When the system recognises the presence of these accessories, it automatically increases the performance based on values defined and calculated by the installer.





WARNING

- The ballast/counterweight must be of the type and in the position established and calculated by the installer.
- There is danger of overturning and risk of serious accidents if the ballast/counterweight or the location are different from the instructions from the installer.



NOTE

The assembly of the kit and the setup of this feature are the sole responsibility of the installer.

6.1.12. FPI Flow Power Increase

This feature automatically provides extra power by reducing the speed smoothly when working close to the rated capacity. When the load decreases, normal speed is restored.

6.1.13. Stand-by feature

With the crane system on, if you do not move any lever for a certain amount of time, Progress and the controller change to stand-by mode.

Restart the crane operation using the controller:

1. Push the emergency stop button of the controller.
2. Release the emergency stop button.
3. Push the 'RESET' button.

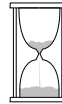

NOTE

- The active features before the stand-by mode will still be active when you restart the crane operation.
- When the crane idle time reaches 8 hours, the whole system automatically switches off. You need to start it again to use the crane.

6.1.14. Progress - Stability control device

Progress allows you to work safely with the crane by reducing the crane lifting capacity, even if the stabiliser system is not fully extended. The performance of the crane depends on the stabiliser extensions position that the system detects.

The position of the **crane stabiliser extensions** is detected proportionally by Progress to calculate the stability.

<p>All positions detected:</p> <ul style="list-style-type: none"> • From 0% to 100% 	<p>Single CroSStab, 3 positions detected:</p> <ul style="list-style-type: none"> • Tab 1: from 3° to 88° • Tab 2: from 88° to 92° • Tab 3: from 92° to 123°

The position of the **auxiliary stabiliser extensions** is not detected proportionally by Progress to calculate the stability.

<p>2 positions detected:</p> <ul style="list-style-type: none"> • 0% • 100% 	<p>3 positions detected:</p> <ul style="list-style-type: none"> • From 0% to 50% = 0% • From 50% to 98% = 50% • From 98% to 100% = 100%

The complete crane operating area is subdivided into four sectors and their width varies according to the extension of the stabiliser extensions. Progress manages

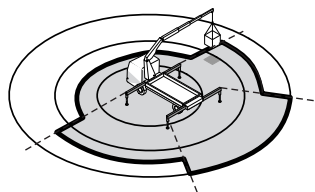

the performance in these four sectors and takes into account the most unfavourable situation in each sector.



NOTE

- If your vehicle has a front and/or rear auxiliary stabiliser system [option], with one or two legs, make sure that all legs are correctly set to the ground before you start operating the crane to get maximum performance.
- If the stabilisers are extended with a different percentage, the system will set the performance of the most unfavourable sector.
- Before starting the crane operation, the system carries out stability checks and fixes the performance depending on the truck weight and dimensions.

• **Standard stabiliser system**

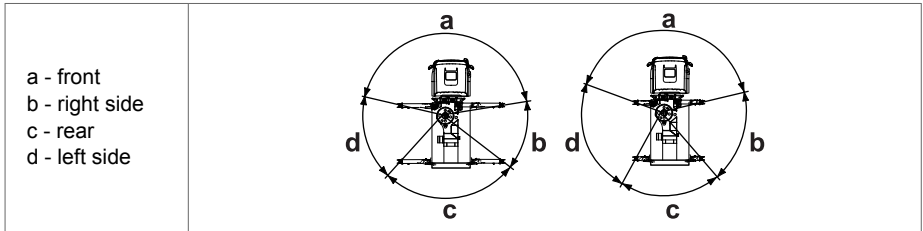

• **CroSStab stabiliser system**

On the CroSStab configuration, the left crane stabiliser extension is able to rotate up to approximately 120°. This configuration allows a higher lifting capacity of the crane in the front operating sector (**A**) compared to a crane with a standard stabilisers system (**a**).

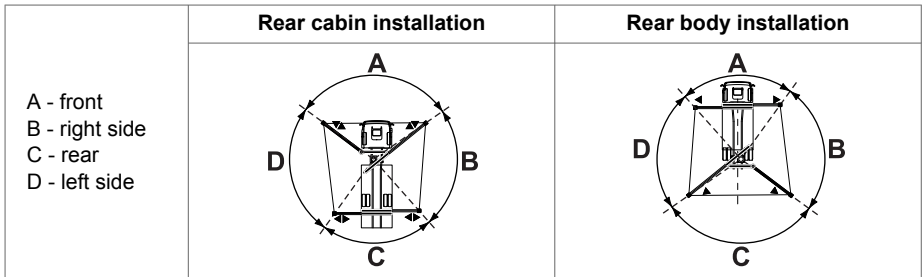

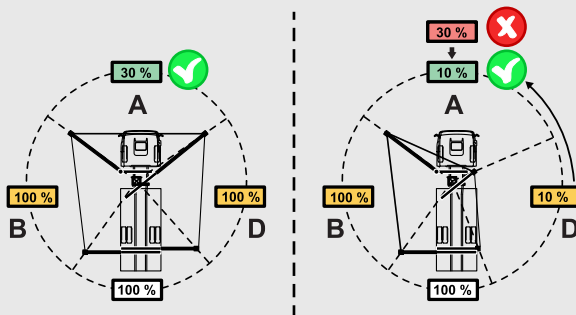

NOTE

The performance in the front sector (A) may be reduced automatically by the system depending on the performance that the crane has on the right (B)/left (D) sector. If the performance in the right/left sector is less than the performance in the front sector, the front sector performance will be reduced according to the smallest performance in the right/left sector.

6.1.15. SENSE [option]

Progress equipped with the SENSE feature detects the position of the stabiliser extensions. This optimises the crane lifting capacity in relation to the vehicle's stability.

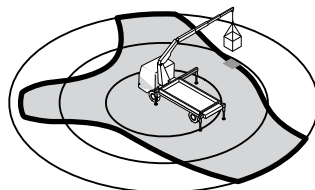
The lifting capacity curve will be the most favourable if all the stabilisers are fully extended. If this is not possible due to the limited space available, the lifting capacity curve will be reduced for the stability of the vehicle. SENSE calculates and manages the performances on 360 different areas: one for each degree of the crane slewing area.



The position of both, **crane stabiliser extensions** (standard and CroSStab) and **auxiliary stabiliser extensions**, are detected proportionally by Progress to calculate the stability.

All positions detected: <ul style="list-style-type: none"> • From 0% to 100% 	All positions detected: <ul style="list-style-type: none"> • From 0° to 123°



NOTE

According to the real stability of the vehicle and the load applied, the SENSE device could limit progressively the lifting capacity starting from 60° of the 2nd boom.

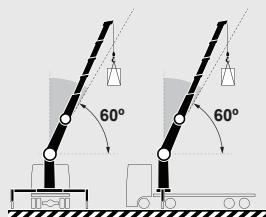

WARNING

Despite the safety feature, always operate the crane with gentle and slow movements in the most unfavourable areas (where the lifting capacity and stability diagram have a sudden change (T)) to avoid overturning. For example, do not operate oscillating loads or slew the crane with high speed.

Effer considers as misuse of the crane:

- positioning on an unstable base.
- sudden movements of the crane with or without oscillating loads.
- excessive lowering speed from the vertical position with simultaneous increase of the load outreach.
- excessive slewing speed of the crane towards unfavorable areas.

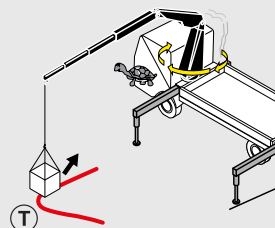

The SENSE diagrams

After the installation on the truck, the installer prints unique stability and load diagrams for each crane.

Performance stability diagram

The EFFER software creates a stability diagram, each coloured curve shows the crane's stable area and the maximum performance with stabiliser extensions in different outreach positions. The more you extend your stabiliser extensions, the more stability and crane's performance you will get.

The diagram shows 10 different sectors surrounding the crane and each sector is a percentage referred to the lifting performance. A percentage of 90 indicates that the available working pressure in the 1st boom cylinder is reduced to 90% in this sector.

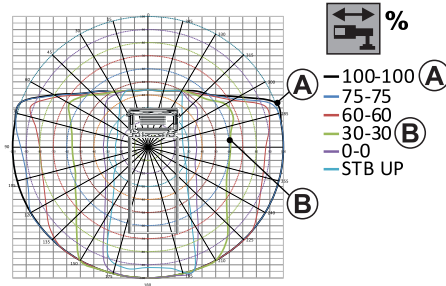

Rated capacity stability diagram

The EFFER software creates different capacity diagrams with the stabiliser extensions in different positions (represented in the icon). For cranes with JIB, other capacity diagrams will be automatically generated.

The software calculates three loads represented by the three coloured curves. These loads are represented by the position of the crane in each sector (degrees) and also by the outreach of the boom extensions (meters).

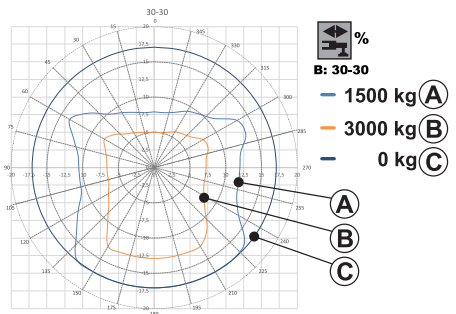
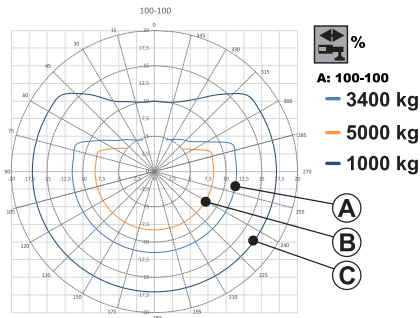

NOTE

Contact your authorised service workshop to request these diagrams for other loads.

Load chart

In this type of diagram, the lifting performance is indicated in a table. Each percentage (%) of the stabiliser extension corresponds to a specific load (kg) that you can lift at a specific outreach (m) with the specific boom.

LOAD TABLE AT FIXED PERFORMANCES									
LOAD CHART	4 boom	4 boom	4 boom	4 boom	4 boom	4 boom	4 boom	4 boom	4 boom
Load (%)	100%	75%	60%	30%	0%	100%	75%	60%	30%
100%	2000 kg	1500 kg	1000 kg	500 kg	0 kg	1500 kg	1000 kg	500 kg	0 kg
75%	1500 kg	1000 kg	500 kg	0 kg	0 kg	1000 kg	500 kg	0 kg	0 kg
60%	1000 kg	500 kg	0 kg	0 kg	0 kg	500 kg	0 kg	0 kg	0 kg
30%	500 kg	0 kg	0 kg	0 kg	0 kg	0 kg	0 kg	0 kg	0 kg
0%	0 kg	0 kg	0 kg	0 kg	0 kg	0 kg	0 kg	0 kg	0 kg

6.1.16. DLC-S Dynamic Load Chart [option]

The DLC-S allows:

a. **A simulation of the stabiliser system position to display the maximum liftable loads**





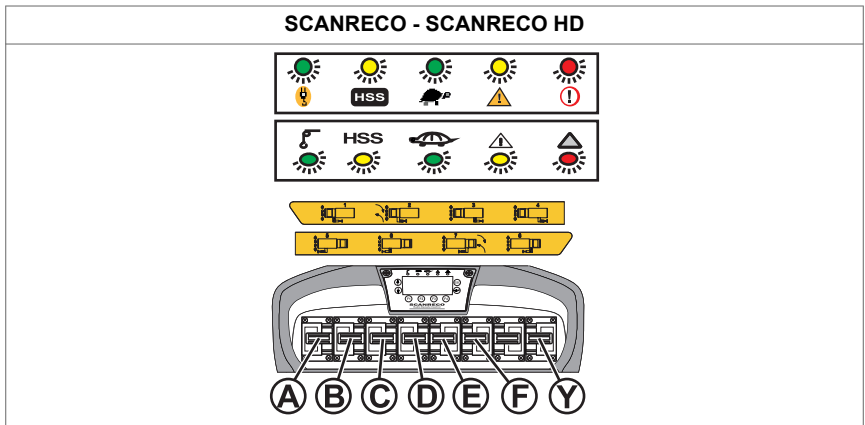

NOTE

This simulation can be activated either when the crane is in transport position or in working position.

1. Switch on the controller without push the reset button.
2. Move the last lever (**Y**) two times in any direction. LEDs on the upper part of the controller are flashing during this simulation mode.
3. Use the levers (**A**), (**B**), (**C**), (**D**) to simulate the extension of the stabiliser extensions. The stabiliser extension percentage value is shown.
4. Use the lever (**E**) if the front and/or rear auxiliary stabiliser system are present for simulation.
5. Use the lever (**F**) if the CroSStab is present for simulation.



The symbols on the corners of the displays show:

SCANRECO	Black background: stabiliser extension is extended 0%. Without background: stabiliser extension is extended >0%.	 
SCANRECO HD	Green background: stabiliser extension is extended 0%. Without background: stabiliser extension is extended >0%.	 

6. Use the lever (**Y**) to run the simulation calculation. During the calculation this symbol  is shown on the display.

7. Read the maximum liftable loads for the rotation current position of the crane on the display:

- The configuration version of the crane or crane + JIB.
- The load values depending on which extensions are extended and considering that they are in the horizontal position.
- The real rotation angle (e.g. 180°).
- The angular variation (e.g. $+40^\circ / -40^\circ$) referred to the real position (e.g.

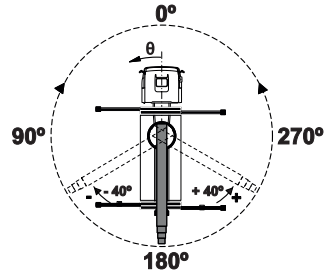

180°). Use the arrow keys on SCANRECO or +/- on SCANRECO HD to change this value increasing or decreasing 10° at a time. The values of the simulation will be automatically updated and displayed.

- The unit of measurement (for example, kg or lbt).

SCANRECO	SCANRECO HD																																																																																				
<p>CRN</p>	<p>CRN</p>																																																																																				
<p>CRN+JIB</p>	<p>CRN+JIB</p>																																																																																				
<table border="1"> <tr><td>0</td><td>35000</td><td>6</td><td>2000</td><td>kg</td><td>(e)</td></tr> <tr><td>1</td><td>20000</td><td>7</td><td>1000</td><td></td><td></td></tr> <tr><td>2</td><td>10000</td><td>8</td><td>900</td><td>C</td><td>(a)</td></tr> <tr><td>3</td><td>8000</td><td>9</td><td>200</td><td>R</td><td>(a)</td></tr> <tr><td>4</td><td>6000</td><td>10</td><td></td><td>N</td><td>(a)</td></tr> <tr><td>5</td><td>4000</td><td>11</td><td></td><td></td><td>(a)</td></tr> <tr><td colspan="5">Rot. 180 dgr</td><td>(d)</td></tr> <tr><td colspan="5"></td><td>(c)</td></tr> </table>	0	35000	6	2000	kg	(e)	1	20000	7	1000			2	10000	8	900	C	(a)	3	8000	9	200	R	(a)	4	6000	10		N	(a)	5	4000	11			(a)	Rot. 180 dgr					(d)						(c)	<table border="1"> <tr><td>0</td><td>1300</td><td>6</td><td></td><td></td><td>(b)</td></tr> <tr><td>1</td><td>1180</td><td>7</td><td></td><td></td><td>(b)</td></tr> <tr><td>2</td><td>1070</td><td>8</td><td></td><td></td><td>(b)</td></tr> <tr><td>3</td><td>900</td><td>9</td><td></td><td></td><td>(b)</td></tr> <tr><td>4</td><td>720</td><td>10</td><td></td><td></td><td>(b)</td></tr> <tr><td>5</td><td></td><td>11</td><td></td><td></td><td>(b)</td></tr> </table>	0	1300	6			(b)	1	1180	7			(b)	2	1070	8			(b)	3	900	9			(b)	4	720	10			(b)	5		11			(b)
0	35000	6	2000	kg	(e)																																																																																
1	20000	7	1000																																																																																		
2	10000	8	900	C	(a)																																																																																
3	8000	9	200	R	(a)																																																																																
4	6000	10		N	(a)																																																																																
5	4000	11			(a)																																																																																
Rot. 180 dgr					(d)																																																																																
					(c)																																																																																
0	1300	6			(b)																																																																																
1	1180	7			(b)																																																																																
2	1070	8			(b)																																																																																
3	900	9			(b)																																																																																
4	720	10			(b)																																																																																
5		11			(b)																																																																																

8. Use the levers on your controller as in step 3 to run other simulations following the previous steps.

9. Push the emergency stop button to exit the simulation mode.

b. Display of liftable loads based on a real stabilisation

- Extend the stabiliser extensions and set the stabiliser legs on the ground stabilising the vehicle according to your needs.
- Push the ENTER button on SCANRECO and **F6** on SCANRECO HD. The “DLC-S” screen appears on the controller’s display.

3. Read the maximum liftable loads for the rotation current position of the crane on the display:

- The configuration version of the crane or crane + JIB.
- The load values depending on which extensions are extended and considering that they are in the horizontal position.
- The real rotation angle (e.g. 180°).
- The angular variation (e.g. +40° / -40°) referred to the real position (e.g.

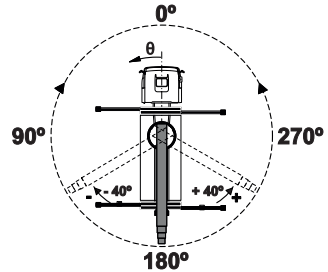

180°). Use the arrow keys on SCANRECO or +/- on SCANRECO HD to change this value increasing or decreasing 10° at a time. The values of the simulation will be automatically updated and displayed.

- The unit of measurement (for example, kg or lbt).

SCANRECO	SCANRECO HD																																																																																				
<p>CRN</p>	<p>CRN</p>																																																																																				
<p>CRN+JIB</p>	<p>CRN+JIB</p>																																																																																				
<table border="1"> <tr> <td>0_</td> <td>35000</td> <td>6_</td> <td>2000</td> <td>kg</td> <td>e</td> </tr> <tr> <td>1_</td> <td>20000</td> <td>7_</td> <td>1000</td> <td></td> <td></td> </tr> <tr> <td>2_</td> <td>10000</td> <td>8_</td> <td>900</td> <td>C</td> <td>b</td> </tr> <tr> <td>3_</td> <td>8000</td> <td>9_</td> <td>200</td> <td>R</td> <td>a</td> </tr> <tr> <td>4_</td> <td>6000</td> <td>10_</td> <td></td> <td>N</td> <td></td> </tr> <tr> <td>5_</td> <td>4000</td> <td>11_</td> <td></td> <td></td> <td></td> </tr> <tr> <td colspan="2">Rot. 180 dgr</td> <td colspan="2"></td> <td></td> <td>d</td> </tr> <tr> <td colspan="2"></td> <td colspan="2"></td> <td>+010</td> <td></td> </tr> </table>	0_	35000	6_	2000	kg	e	1_	20000	7_	1000			2_	10000	8_	900	C	b	3_	8000	9_	200	R	a	4_	6000	10_		N		5_	4000	11_				Rot. 180 dgr					d					+010		<table border="1"> <tr> <td>Rot. 180 dgr</td> <td>0_</td> <td>1300</td> <td>6</td> <td></td> <td></td> </tr> <tr> <td></td> <td>1_</td> <td>1180</td> <td>7</td> <td></td> <td></td> </tr> <tr> <td></td> <td>2_</td> <td>1070</td> <td>8</td> <td></td> <td></td> </tr> <tr> <td></td> <td>3_</td> <td>900</td> <td>9</td> <td></td> <td></td> </tr> <tr> <td></td> <td>4_</td> <td>720</td> <td>10</td> <td></td> <td></td> </tr> <tr> <td></td> <td>5_</td> <td></td> <td>11</td> <td></td> <td></td> </tr> </table>	Rot. 180 dgr	0_	1300	6				1_	1180	7				2_	1070	8				3_	900	9				4_	720	10				5_		11		
0_	35000	6_	2000	kg	e																																																																																
1_	20000	7_	1000																																																																																		
2_	10000	8_	900	C	b																																																																																
3_	8000	9_	200	R	a																																																																																
4_	6000	10_		N																																																																																	
5_	4000	11_																																																																																			
Rot. 180 dgr					d																																																																																
				+010																																																																																	
Rot. 180 dgr	0_	1300	6																																																																																		
	1_	1180	7																																																																																		
	2_	1070	8																																																																																		
	3_	900	9																																																																																		
	4_	720	10																																																																																		
	5_		11																																																																																		

- Push the button on SCANRECO or on SCANRECO HD to return to the display screen of the load values according to the real position.
- Push the button on SCANRECO or on SCANRECO HD to exit the screen.

6.2. Overload protection (Load limiter device)

6.2.1. Crane overload protection

Progress not only prevents overloading of the crane stopping specific crane movements when the maximum operating performance is reached, but it also controls the speed of the crane/hook tip.

This way, if more movements are carried out at the same time, the crane tip/hook speed does not exceed the safety values that would cause control problems during operation (MAX SPEED LIMITATION feature).



NOTE

For more information about the visual warning on the User interface with LEDs, refer to the content: "[Section 4.7.1: Indicator LEDs on the User Interface \(page 52\)](#)".

Thus, this is what can happen while you operate the crane:

- **The crane automatically slows down some movements even if no load is on the hook.**

This occurs automatically when:

- The crane reaches special configurations, for example when it approaches the crane boom max verticality or when the cylinder is reaching its end of stroke.
- You activate several simultaneous movements with the controller. As the available oil is proportionally distributed in the valve so that all movements receive enough oil (refer to the FLOW SHARING feature), the speed of the first active movements is reduced.

- **A movement in one direction is blocked** when the crane reaches the max allowed geometric configuration.

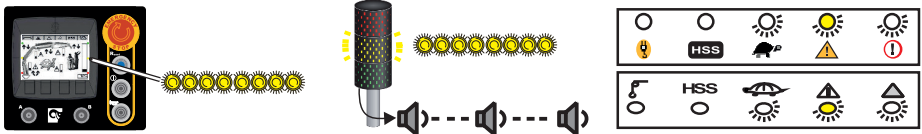

- **Slewing movements stopped.**

When operating the crane, Progress stops the slewing movements if the crane is about to go into an area where the vehicle stability is low.

Retract the boom extensions to be able to continue with the slewing operation.

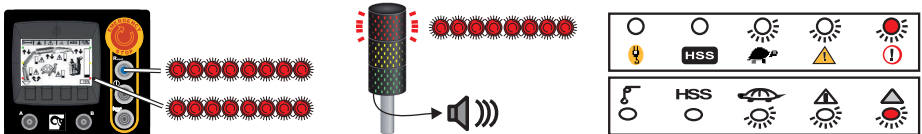

• **Crane with load on the hook.**

When the pressure inside a boom moving cylinder (1st boom, 2nd boom, JIB) approaches 70% of the max pressure allowed (max pressure = max crane performance), the slow-down begins.

- The green LED turns on and the turtle icon is shown.

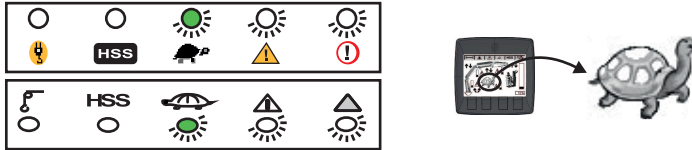

When you operate the crane and reach the 90% of the max performance:

- The yellow lamp on the column lights is flashing.
- A slowly intermittent sound is activated on the horn.
- The yellow LED goes on.

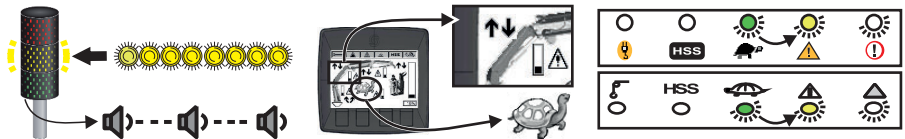

• **When 100% of the maximum permitted pressure is reached**, the system stops all functions that increase the pressure.

- On the column lamp, the red light is flashing.
- A quick intermittent sound is activated from the horn.
- On the display panel, the red light is flashing.
- On the User Interface, the red light of the reset LED is flashing.
- The yellow LED on the controller turns off and the red LED is flashing.

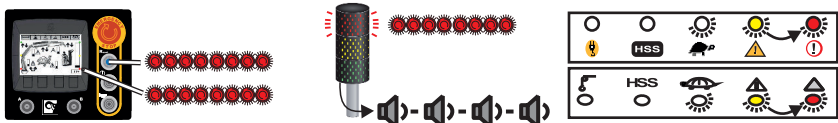

Unlocking crane movements in overload situations

If the maximum lifting capacity is reached, the system stops all crane movements that could worsen the stability. You can see on the display panel and on the controller which movements are not allowed (100% overload) and which are still permitted to correct the overload situation.

Display	SCANRECO	SCANRECO HD



NOTE

If you are in an overload situation where no movement is allowed, follow the procedure: "[Section 6.2.2: Release the overload protection \(page 116\)](#)".

6.2.2. Release the overload protection

If all functions have been blocked due to an overload situation, it is possible to temporarily release it and operate an appropriate crane function to correct the overload situation.

Proceed as follows:

1. Push the RESET button on the controller. The LED on the RESET button turns off, the LED on the controller becomes yellow, and the overload release is active in 10-second intervals.
2. Operate the crane using smooth and gentle movements to get the crane out of a locked position. During this time, you can operate only one function at a time and never the boom extension out.

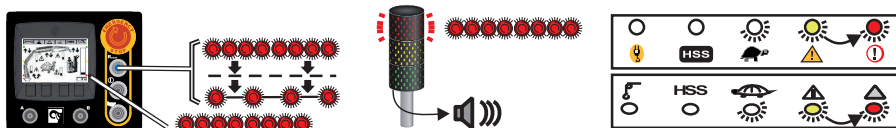

3. After a 10-second interval, the red lamp and the RESET button LED blink for 30 seconds (the waiting time).



NOTE

When operating the boom system/JIB over 70°, the waiting time is reduced to five seconds.

After this time, it is possible to operate another movement following the same procedure.



NOTE

The procedure described above can be repeated up to five times. After that, only the operation to retract the boom extensions is available.



WARNING

Only use the overload release to get the crane out of a locked position. Never use the overload release to overload the crane deliberately!



NOTE

In case of a crane breakdown, the use of the overload release will be part of the investigation. If the use of overload release is too excessive, it might affect the warranty.

6.3. Truck stability conditions

- If a stabiliser leg is no longer in contact with the ground, the system allows crane operation and shows a warning signal.

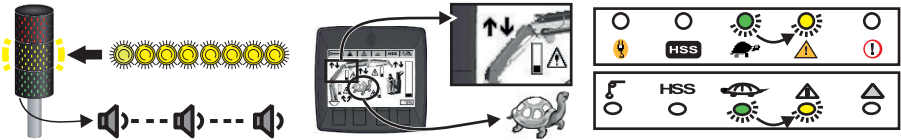

- If two stabiliser legs are no longer in contact with the ground, the system stops all crane movements that could worsen the stability. You can see on the display panel and on the controller which movements are not allowed and which are still permitted to correct the overload. Retract the boom extensions to get the crane out of a locked position (it is usually the only movement allowed in this case).

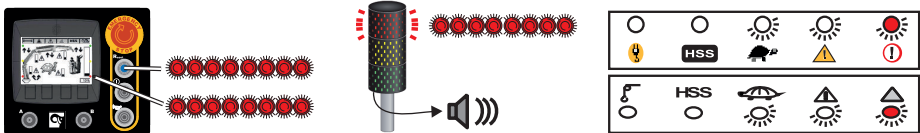

NOTE

The stabiliser legs overload is considered in the stability calculations.

6.4. Manual extensions [if installed]

Operation with manual extensions:

- Use the manual extensions only when you need the longest outreach, otherwise remove them.
- The manual extension load limits are controlled by Progress.



DANGER

- Do not stand in front of moving parts. They may eventually move and cause injuries.
- Before driving with the crane, make sure that you fully retract the manual extension and lock them correctly. Make sure that they stay within the width of the truck.



CAUTION

To prevent a safety risk and to get the maximum performance on the crane:

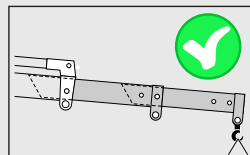
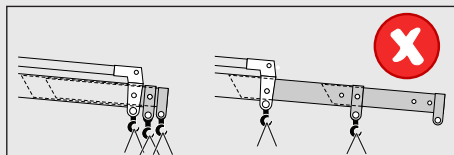
- You must always attach the load to the last extension.
- Never attach the load to an extension which has other extensions included inside it.

How to assemble and disassemble the manual extensions:

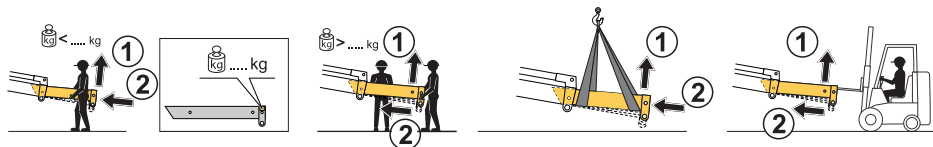
Select the correct lifting device according to the weight of the extension.

Assembly procedure:

1. Operate the hydraulic extension a small distance below the horizontal.
2. Slightly incline the manual extension (1) and insert it (2).
3. Align the holes in both extensions and lock the extensions with the locking pins and the locking shafts (A).
4. Repeat the same operation if you have more than one manual extension.

Dismantling procedure:

1. Operate the hydraulic extension a small distance below the horizontal.
2. Remove the locking pins and the locking shafts (A).
3. Raise the manual extension to avoid the stop (B), if installed, and slide it out carefully.
4. Repeat the same operation if you have more than one manual extension.

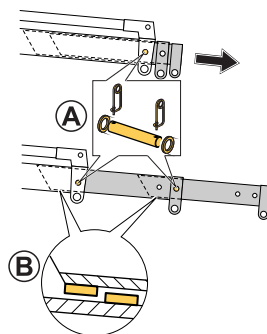



CAUTION

- Make sure that the manual extensions are always properly locked by the locking pins and the locking shafts **(A)**.
- Do these operations carefully to avoid damaging the stop **(B)**, if installed.
- If there is no stop **(B)**, you must extract the extension carefully because it could fall suddenly when you take it out.

To extend the manual extensions:

1. Put the boom system as close as possible to the horizontal position, but low enough to reach the extension by hand or with the lifting device.
2. Push the stop emergency button to stop the crane.
3. Remove the locking pins and the locking shafts **(A)**.
4. Fully extend the manual extension by hand.
5. Secure the manual extension with the locking pins and the locking shafts **(A)**.

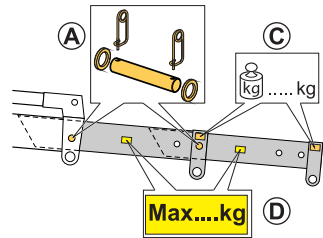

DANGER

- Make sure that the locking devices are properly locked.
- Each manual extension is marked with its own weight **(C)**.
- Each manual extension has a sign **(D)** for the maximum load that can be handled.
- Do not lift loads heavier than the values stated on the sign **(D)**.

To lift heavier loads than specified on the sign **(D)**, move the hook to the nearest hydraulic extension and refer to the load plate on the crane.

To retract the manual extensions:

1. Put the boom system as close as possible to the horizontal position, but low enough to reach the extension by hand or with the lifting device.
2. Push the stop emergency button to stop the crane.
3. Remove the locking pins and the locking shafts **(A)**.
4. Fully retract the manual extension by hand.
5. Secure the manual extension by locking the locking pins and the locking shafts **(A)**.



DANGER

Make sure that the locking devices are properly locked.

6.5. The 9th extension [option]

This feature is valid for cranes where the 9th extension does not extend automatically.

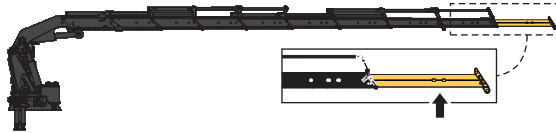

- The activation of this feature is only available from the remote control.
- To extend the 9th extension, the first four hydraulic extensions must be fully extended and the fifth extension must have started to be extended.
- When retracting the extensions, always retract the 9th extension first and then the rest of the extensions.



NOTE

The 9th extension has a separate hydraulic circuit, thus it works independently from the rest of the hydraulic extensions.

How to activate the feature:

To operate the crane extensions you have to move the lever (D) on the controller.

To activate the 9th extension operation you must activate the hydraulic circuit:

1. Press the button (R).
2. Operate the lever for the crane extensions (D).

SCANRECO - SCANRECO HD

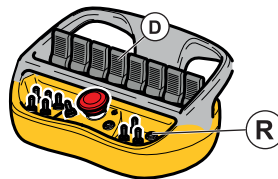

3. To retract the 9th extension, operate the lever for the crane extensions (D).



NOTE

To retract the 9th extension, you do not need to push the button/selector (R).



CAUTION

The HSS feature is not active for the 9th extension.

The operating speed of the 9th extension is lower than the speed of the rest of the crane extensions.

Emergency procedure when the controller has no power or is damaged

When there is no power or the controller is damaged, the 9th extension cannot be operated. Retract all crane extensions following the procedure in the chapter: "emergency operation".



CAUTION

Always contact an authorised service workshop after this operation, as they must restore the correct crane operation.

6.6. Hydraulic connections

6.6.1. Hydraulic couplings [option]

Hydraulic couplings allow a faster connection and disconnection of each hydraulic line.



WARNING

- Switch off the control system and the PTO before connecting or disconnecting the connectors.
- Always remove/attach first the electrical connection before the hydraulic connection.
- Keep the electrical and hydraulic protection caps and bypass in good conditions and store them in a safe place.

To connect the hydraulic couplings you must:

1. Switch off the control system.
2. Disengage the PTO.
3. Connect the respective hydraulic couplings taking care with the corresponding identification.

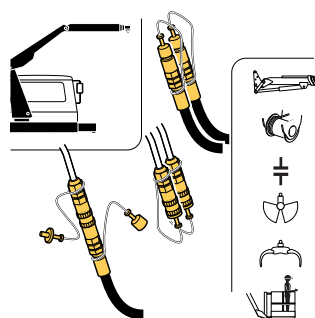

NOTE

To prevent damage, do not change the hydraulic couplings position.

4. Reconnect the PTO and switch on the system, if needed.
5. Do a functional test of all movements of the accessories to verify that there are no mistakes in the connections.

To disconnect the hydraulic couplings you must:

1. Switch off the control system.

2. Disengage the PTO.
3. Disconnect the hydraulic couplings, and protect them with protective caps.
4. Reconnect the PTO and switch on the system, if needed.
5. Operate the crane to verify that all functions work correctly.

6.6.2. Multi-connection hydraulic quick couplings (quickfaster) [option]

Hydraulic quick couplings allow the connection of several hydraulic lines at the same time.



WARNING

- Switch off the control system and the PTO before connecting or disconnecting the connectors.
- Always remove/attach first the electrical connection before the hydraulic connection.
- Keep the electrical and hydraulic protection caps and bypass in good conditions and store them in a safe place.

To connect the hydraulic couplings you must:

1. Switch off the control system.
2. Disengage the PTO.
3. Push the red button (B) to release the lever (A).
4. Turn the lever (A) and connect the hydraulic coupling (C).
5. Turn the lever (A) to its initial position. Make sure that the red button (B) locks the connection correctly.
6. Reconnect the PTO and switch on the system, if needed.
7. Operate the crane.

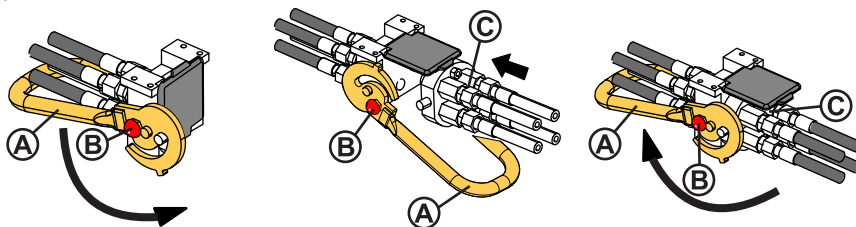

To disconnect the hydraulic couplings you must:

1. Switch off the control system.
2. Disengage the PTO.
3. Push the red button (B) to release the lever (A).
4. Turn the lever (A) and disconnect the hydraulic coupling (C).
5. Turn the lever (A) to its initial position. Make sure that the red button (B) locks the connection correctly.
6. Reconnect the PTO and switch on the system, if needed.
7. Operate the crane.

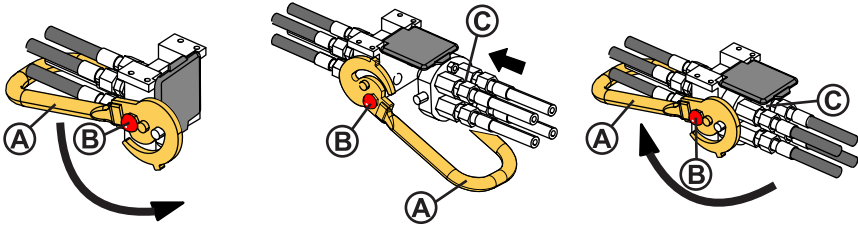

6.7. Electrical connections [option]

WARNING

- Switch off the control system and the PTO before connecting or disconnecting the connectors.
- Always remove/attach first the electrical connection before the hydraulic connection.
- Keep the electrical and hydraulic protection caps and bypass in good conditions and store them in a safe place.

To connect the accessory electrically you must obey the following procedures:

- With the JIB, lifting platform and hoist on the JIB, connect the plug (A) mounted on the JIB to the box (B) mounted at the end of the crane hydraulic extensions.
- With the rotator and the grab, connect the connector (A) directly to the box (B).
- With the hoist on the crane, plug the hoist connector into the pin (C).

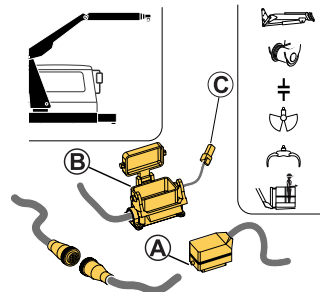
To disconnect the accessory electrically you must:

- Disconnect electrical connector plug (A) of the accessory from the socket (B) on the crane.
- With a hoist (with pulley on the crane), disconnect the connector and connect the electrical bypass on the cable (C) located on the crane.
- Insert the protection cap in the accessory electrical plug.

7. Ending crane operation

7.1. Operate the boom system into transport position



WARNING

A crane with interchangeable equipment and/or optional crane components can differ from the operations described in this section. For this reason, study the operating instructions for any interchangeable equipment and/or optional crane components carefully.



DANGER

- With remote controlled cranes, stay in a safety area while the boom system is moving.
- We recommend that you do these operations slowly or use the option for reduced speed.



7.1.1. Operate the boom system

1. Retract the extensions completely (1).



CAUTION

The extensions might not retract in sequence.

2. Raise the 1st boom (2) until the boom deployment assistance allows you to fold the 2nd boom or $\beta > 45^\circ$.
3. Slew the crane to the parking position. Verify that the yellow arrows signs (A) on the column and on the base are aligned.
4. Operate the 2nd boom against the 1st boom (3).



CAUTION

Be very careful not to cause damage to the slewing motors.

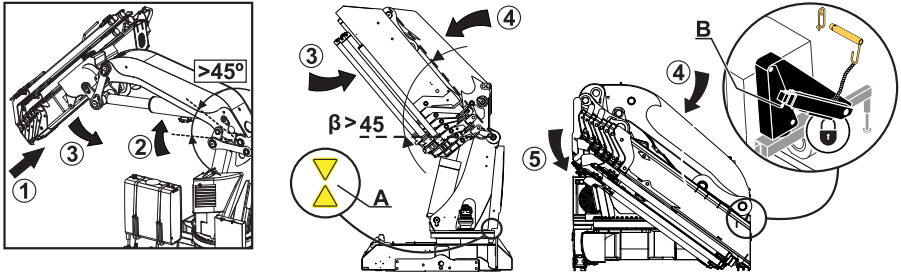

5. Lower the 1st boom completely (4) to the parking support of the base.



CAUTION

Do these operations slowly not to cause damage to the parking support.

6. Lightly operate the 2nd boom (5) against the parking support (B) of the column until it has contact with the support.



CAUTION

Take care not to cause damage to the 2nd boom and the support during these operations.

Do not apply too much force on the parking support.

7. Insert the safety pin that locks the 1st boom (if installed).
8. Fold the hook.

7.2. Operating the stabiliser system into the transport position



DANGER

Do not stand in the stabiliser legs tilting area.



WARNING

- Do not put your foot on the support plate.
- Risk of crushing injuries.
- Always keep hands away from moving parts during operation.



**WARNING**

Do not operate any stabiliser leg up if you still have load on the crane.

The procedure of operating the crane and auxiliary [option] stabiliser legs differs depending on the type of stabiliser leg. Repeat the instructions for the stabiliser extension and leg on the other side of the vehicle.

**DANGER**

Always ensure that the stabiliser legs and the stabiliser extensions are in transport position and securely locked before moving the vehicle.

• Remote controlled stabiliser system:

1. Lift up and move the selector (**V**) to 'STAB' mode on the controller.
2. Push the timed button that is on the same side.

Non-tiltable stabiliser legs

1. Retract the stabiliser leg completely.
2. Retract the stabiliser extension completely. Make sure that it is security locked. (Refer to the section: "Retract the stabiliser extensions (page 128)").
3. Remove the extra support plate (1).

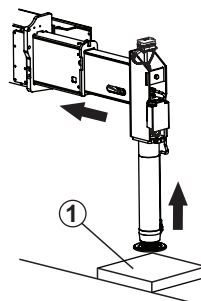
**WARNING**

Risk of crushing injuries.

Always keep hands away from moving parts during operation.

Hydraulically-controlled tiltable stabiliser legs (180°)



DANGER

Stay away from the tilting area of the stabiliser leg.

When the leg turns, there is a risk of injury.

Always keep your hands away from the moving parts during this operation.

Make sure the tilting mechanism remains unlocked during the complete tilting.

1. Turn lever **(A)** to the horizontal position.
2. Retract the stabiliser leg completely.
3. Remove the extra support plate.
4. Turn lever **(A)** to the vertical position.
5. Remove the cotter pin and the pin **(B)**.
6. Operate the rotation stabiliser leg lever. The stabiliser leg will now rotate automatically to vertical position.
7. Insert the pin and cotter pin **(B)** to lock the stabiliser leg.
8. Retract the stabiliser extension completely. Make sure that it is security locked. (Refer to the section: "[Retract the stabiliser extensions \(page 128\)](#)").

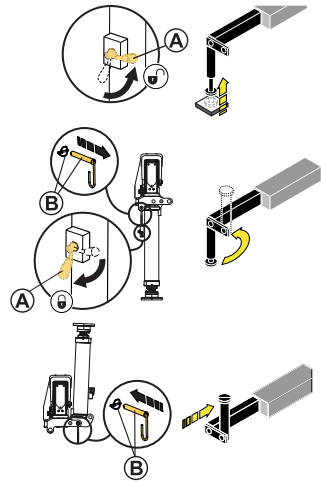

WARNING

- Always do a check that the stabiliser legs and the stabiliser extensions are in the correct position and that the tilting mechanism is locked in transport position.
- Remember that the valve lever of the stabiliser leg has two positions:
 - In the horizontal position **(A)**, it activates the stabiliser leg up/down movements.
 - In the vertical position **(B)**, it activates the stabiliser leg tilting movement.

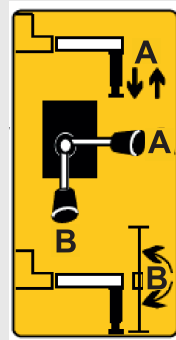

Retract the stabiliser extensions

The procedure of retracting the crane and auxiliary [option] stabiliser extensions differs depending on the type of stabiliser extensions. Repeat the instructions for the stabiliser extension on the other side of the vehicle.

Hydraulically controlled stabiliser extensions

1. Make sure that you have full view of the stabiliser system, and push the timed button that is on the same side of each stabiliser extension/leg.



NOTE

The button will light up during operation of the stabiliser system on that side. If the time expires before you finish the operation, push it again.



WARNING

- Do not let another person push the timed button.
- You must always have a clear view of the stabiliser system when operating.
- Do not push the timed button on one side of the vehicle and then move to the opposite side and move the stabilisers.

2. Retract the stabiliser extensions with the levers on the controller depending on your crane configuration.



DANGER

Before you retract the stabiliser extensions:

- Make sure that you can see them clearly during their operation.
- Be prepared to reduce the speed of the operation to prevent accidents.
- Make sure that the stabiliser legs are fully up and locked.

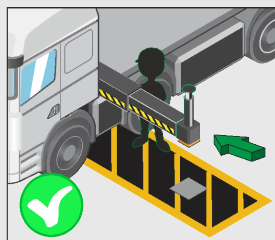

- Verify that the mechanical stops are locking the system correctly (pin (C) locked by the catcher (A)).

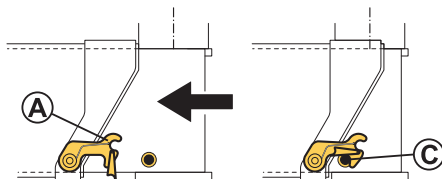

CroSStab stabiliser system

- Make sure that you have full view of the stabiliser system, and push the timed button that is on the same side of each stabiliser extension/leg.



NOTE

The button will light up during operation of the stabiliser system on that side. If the time expires before you finish the operation, push it again.



WARNING

- Do not let another person push the timed button.
- You must always have a clear view of the stabiliser system when operating.
- Do not push the timed button on one side of the vehicle and then move to the opposite side and move the stabilisers.

- Retract the stabiliser extensions with the levers on the controller depending on your crane configuration.



DANGER

Before you retract the stabiliser extensions:

- Make sure that you can see them clearly during their operation.
- Be prepared to reduce the speed of the operation to prevent accidents.
- Make sure that the stabiliser legs are fully up and locked.

- Verify that the mechanical stops are locking the system correctly (pin **(C)** locked by the catcher **(A)**).

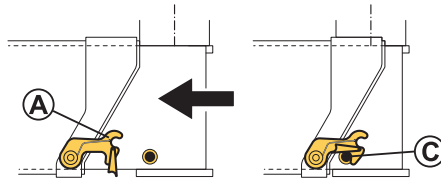

- Rotate completely the stabiliser extension **(S)**.



CAUTION

- Do not rotate the stabiliser extension **(S)** until you have the stabiliser extensions completely retracted.
- During the stabiliser extension rotation, you must stay in a safe area and make sure that there are no other persons within the rotation area.

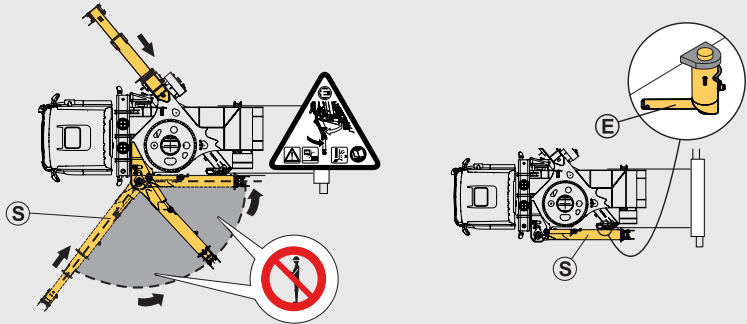

- Make sure that the rotation stabiliser locking device **(E)** is locked properly.
- Remove the chocks under the vehicle wheels.



NOTE

Common storage position with non-tiltable stabiliser legs.

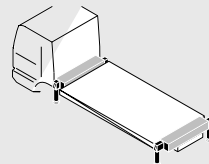

Common storage position with hydraulically tiltable stabiliser legs.

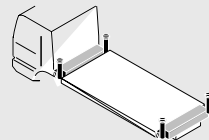

7.3. Switching off the control system

1. Push the emergency stop button on the controller to switch it off.
2. Disengage the PTO.

The control system switches off automatically when the PTO is disengaged.

If this feature is not activated:

- Push the ON/OFF button  on the User Interface (A) to switch off the control system.

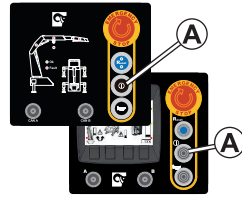

7.4. Emergency operation

7.4.1. Display messages and password



WARNING

- The use of any emergency operation is under your direct responsibility as operator of the crane.
- You must be qualified and correctly trained in the emergency operation to use the manual commands unit. Pay careful attention when operating from the operator station (crushing, falling, etc...) and watch out for hidden hazards (low visibility, narrow spaces, etc...).
- Always operate the crane with caution and at reduced speed.
- To operate the crane like this is HIGHLY DANGEROUS because during emergency operation all crane security is disconnected.
- It is strictly forbidden to use any emergency operation as normal operation (for example lifting a load).
- Always go to/contact an authorised service workshop when a security seal has been broken.

The controller and the display panel [option] show information about the cause of all malfunctions with a code and a description. Contact an authorised service workshop to understand the errors.

The messages can be about:

- **Warning:** the crane remains operative and the messages inform the driver about specific operating conditions.
- **Alarm:** the crane is no longer operative. It is possible to reset several alarms and continue operating the crane, but there are also alarms that require the support of technical service.



NOTE

When you enter the password to disable all the control and safety systems on the crane, Progress saves the date and the time in which you use the crane with the safety systems disabled.

Contact an authorised service workshop to get the password.

**NOTE**

If your password does not allow movements of the crane or the stabiliser system to fold the crane in transport position, you must operate the crane manually.

7.4.2. Bypass Progress (crane - stabilisers) procedure**WARNING**

- The use of any emergency operation is under your direct responsibility as operator of the crane.
- You must be qualified and correctly trained in the emergency operation to use the manual commands unit. Pay careful attention when operating from the operator station (crushing, falling, etc...) and watch out for hidden hazards (low visibility, narrow spaces, etc...).
- Always operate the crane with caution and at reduced speed.
- To operate the crane like this is **HIGHLY DANGEROUS** because during emergency operation all crane security is disconnected.
- It is strictly forbidden to use any emergency operation as normal operation (for example lifting a load).
- Always go to/contact an authorised service workshop when a security seal has been broken.

**NOTE**

- An acoustic signal (from the horn), repeated 3 times every 15 minutes, indicates that the crane is working in bypass mode.
- This bypass mode will be disabled as soon as the crane is switched off.
- The bypass remains active for 30 minutes and it can be activated a maximum of 3 times in 24 hours.
- Contact an authorised service workshop after using this emergency operation to reset the system.

1st - Bypass procedure with Progress disabled:

Before to start the procedure, read carefully the following procedure and contact an authorised service workshop to get the password.

1. Turn OFF the control system.
2. Lift up and turn the selector 'CRANE/STAB' to 'STAB' on the controller.
3. Turn ON the control system.
4. Push the **Reset Button** when required by the system.
5. Within two minutes of switching ON the control system, push and keep pushed the **Reset Button**.
6. In the meanwhile, push or pull one by one the firsts four lever from left of controller to insert the password.
7. Push and release the emergency button on the controller.
8. Push the **Reset Button** when required.
9. An acoustic signal repeated 2 times and an icon on the controller display indicates that the bypass mode is activated.
10. Go to the 2nd procedure if the crane is still stopped.

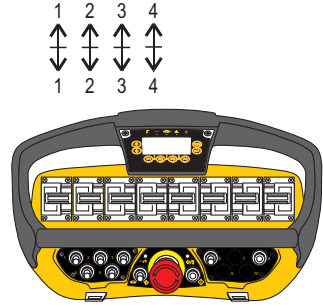

NOTE

When you enter the password to disable all the control and safety systems on the crane, Progress saves the date and the time in which you use the crane with the safety systems disabled.

Example:

Given password 3568

Type 3: Push or pull 3 times the first lever from the left.

Type 5: Push or pull 5 times the second lever from the left.

Type 6: Push or pull 6 times the third lever from the left.

Type 8: Push or pull 8 times the fourth lever from the left.



NOTE

If in the code provided by the authorised service workshop, one or more of the numbers of the password is zero, always replace the zero with one.

Example: given password 3068 = 3168

NOTE

If your crane is equipped with a controller with joysticks, refer to the drawing below to know the layout of the levers

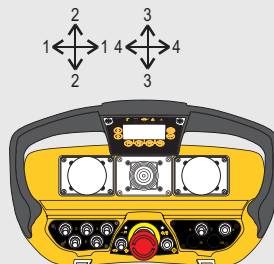
2nd - Bypass procedure with PROGRESS device off

Switch off Progress with the ON/OFF button  on the User Interface.

FOR HAWE MAIN CONTROL VALVE with protective cover (A)

1. Remove the caps (C) that protect the screws (D) and (E).
2. Break the security seal (G) on the screws (D) and (E).
3. Remove the Allen key (F) on the support of the control valve. Use the Allen key to screw/unscrew the screw (D) and (E).

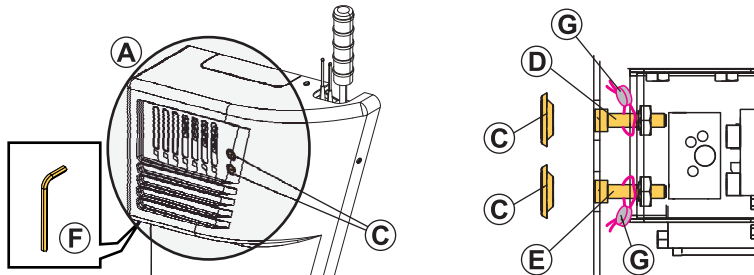

CRANE emergency operation:

- Loosen the screw **(D)**.
- Tighten the screw **(E)** up to the stop.
- Use the levers on the control valve and move the crane as indicated in the section: crane movements in an emergency.

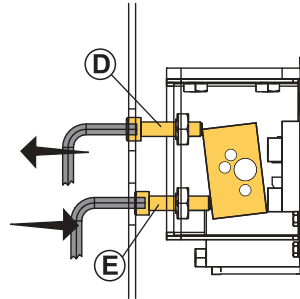

NOTE

No levers are assembled on the control valve. All levers are supplied separately and must be removed after emergency use.

STABILISER SYSTEM emergency operation:

- Loosen the screw **(E)**.
- Tighten the screw **(D)** up to the stop.
- Move the stabilisers using the solenoid valves unit, as indicated in the section: stabiliser system movements in an emergency.

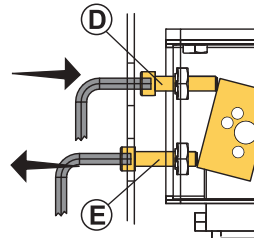

CAUTION

- Always contact an authorised service workshop after this operation, as they must restore the correct crane operation.
- Release screws **(D)** and **(E)** to the initial position.
- The authorised service workshop must add the new security seals **(G)**.

FOR HAWE MAIN CONTROL VALVE with protective cover **(B)**

- Break the security seal **(C)** and remove the Allen key **(D)** located on the control valve support.
- Unscrew the screws **(E)** and **(F)** with the Allen key **(D)**.
- Unscrew the knob **(G)**.
- Remove the control valve safety cover **(B)**.

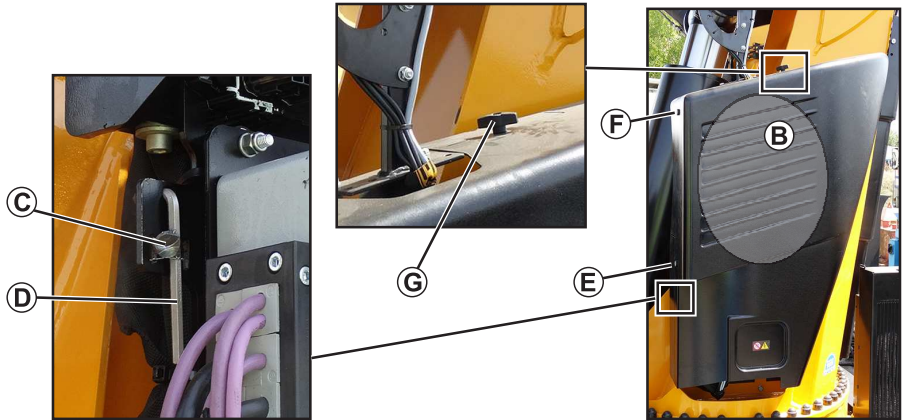

5. Break the security seal **(H)** on the bypass device.
 6. With the knob **(G)**, use the bypass device to activate the manual emergency operation of the crane or the stabilisers to the transport position.
- During normal operation, the device **(I)** must be in a released position and without the knob **(G)**.

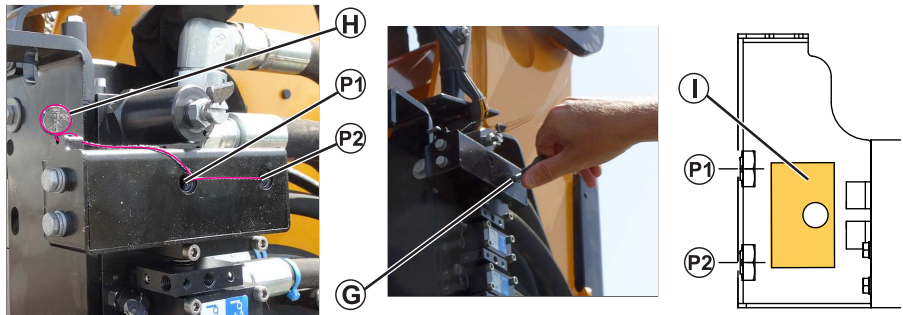

CRANE emergency operation:

- Screw the knob **(G)** in position **(P2)** until it stops.
- Use the levers on the control valve and move the crane as indicated in the section: crane movements in an emergency.

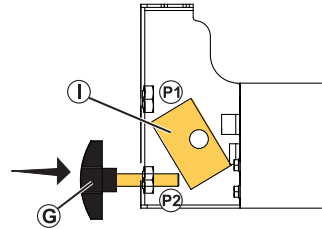

NOTE

No levers are assembled on the control valve. All levers are supplied separately and must be removed after emergency use.

STABILISER SYSTEM emergency operation:

- Screw the knob **(G)** in position **(P1)** until it stops.
- Move the stabilisers using the solenoid valves unit, as indicated in the section: stabiliser system movements in an emergency.

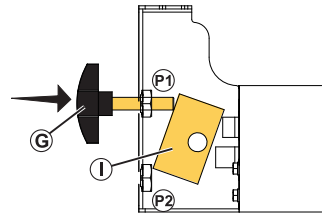

CAUTION

- Always contact an authorised service workshop after this operation, as they must restore the correct crane operation.
- Release the knob **(G)** and place it on its initial position after placing the control valve safety cover **(B)**.
- The authorised service workshop must add the new security seals **(C)** and **(H)**.

7.4.3. Crane movements in an emergency



WARNING

- The use of any emergency operation is under your direct responsibility as operator of the crane.
- You must be qualified and correctly trained in the emergency operation to use the manual commands unit. Pay careful attention when operating from the operator station (crushing, falling, etc...) and watch out for hidden hazards (low visibility, narrow spaces, etc...).
- Always operate the crane with caution and at reduced speed.
- To operate the crane like this is **HIGHLY DANGEROUS** because during emergency operation all crane security is disconnected.
- It is strictly forbidden to use any emergency operation as normal operation (for example lifting a load).
- Always go to/contact an authorised service workshop when a security seal has been broken.

EMERGENCY operation to bring the crane to transport position

1. Turn off the controller.
2. Remove the protective cover of the main control valve.
3. Install all the emergency levers supplied on the main control valve.

Operate only one function at a time.

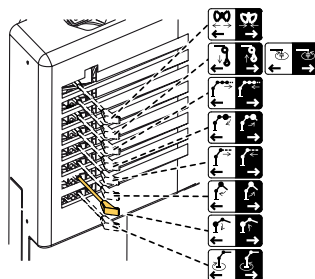

NOTE

No levers are assembled on the control valve. All levers are supplied separately and must be removed after emergency use.

4. Remove all the emergency levers and put the cover.
5. Go to an authorised service workshop to set the crane again to the normal operation.

7.4.4. Stabiliser system movements in an emergency



WARNING

- The use of any emergency operation is under your direct responsibility as operator of the crane.
- You must be qualified and correctly trained in the emergency operation to use the manual commands unit. Pay careful attention when operating from the operator station (crushing, falling, etc...) and watch out for hidden hazards (low visibility, narrow spaces, etc...).
- Always operate the crane with caution and at reduced speed.
- To operate the crane like this is **HIGHLY DANGEROUS** because during emergency operation all crane security is disconnected.
- It is strictly forbidden to use any emergency operation as normal operation (for example lifting a load).
- Always go to/contact an authorised service workshop when a security seal has been broken.



WARNING

Use this operation only as an **EMERGENCY** operation to bring the stabiliser system to transport position.

Procedure for stabiliser control valves without emergency levers:

1. Remove the cover of the stabiliser control valve.
2. Break the security seal.
3. Activate the emergency operation of the main solenoid valve by pushing the spool and turning it clockwise until it is locked.

The knurled spool on the control valves has two positions:

(2a) lifted for normal operation.

(2b) lowered for emergency operation.

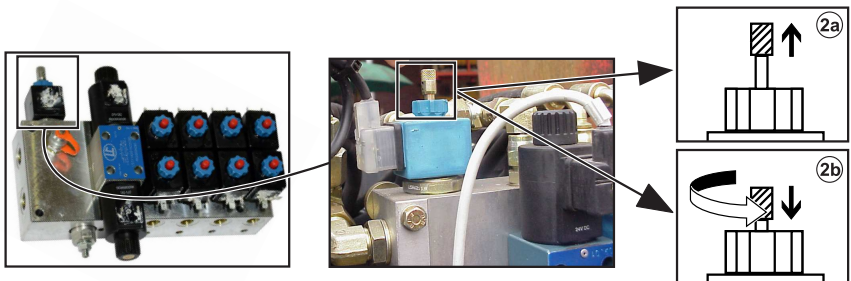

4. Identify the specific spool for the movement you need (stabiliser extensions and legs).

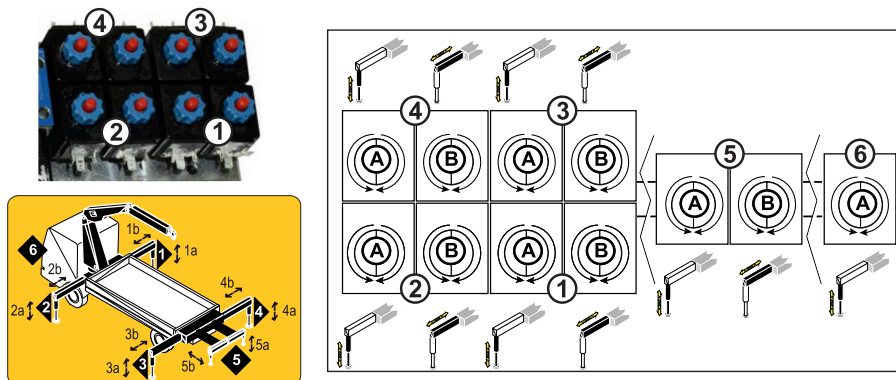

5. Move the stabiliser legs or extensions.

5a. Unscrew the red spool related with the stabiliser leg or extension you want to move.

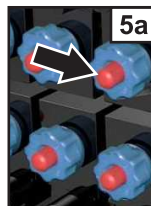

5b. Press the spool cursor with a sharp object for:

- Operate up/down the stabiliser leg.
- Retract the stabiliser extension/tilt the stabiliser leg.

5c. Screw back the red spool as soon as the movement is complete.

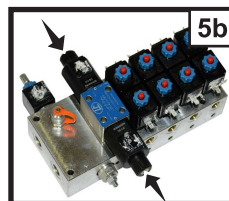

CAUTION

- Always contact an authorised service workshop after this operation, as they must restore the correct crane operation.
- Release the knob and the spools to their initial position and protect them with the control valve safety cover.
- The authorised service workshop must add the new security seal.

Procedure for stabiliser control valves with emergency levers:

1. Remove the cover of the stabiliser control valve.
2. Break the security seal.
3. Activate the emergency operation of the main solenoid valve by pushing the spool and turning it clockwise until it is locked.

The knurled spool on the control valves has two positions:

- (a) lifted for normal operation.
- (b) lowered for emergency operation.

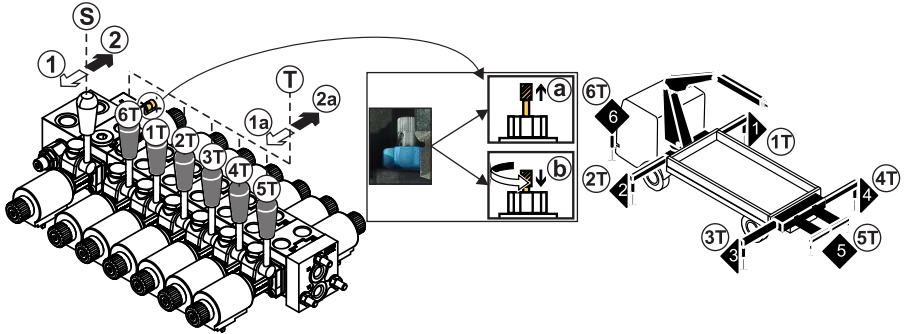

4. Identify the specific spools for the movement you need (stabiliser extensions and legs).

Lever S:

- Position (1): retract the stabiliser extension / stabiliser leg up.
- Position (2): extend the stabiliser extension / stabiliser leg down.

Lever T:

- Position (1a): selects the stabiliser extension movement.
- Position (2a): selects the stabiliser leg movement.



CAUTION

- Always contact an authorised service workshop after this operation, as they must restore the correct crane operation.
- Release the knob and the spools to their initial position and protect them with the control valve safety cover.
- The authorised service workshop must add the new security seal.

7.5. Transport warning

The system detects that the stabilisers and crane boom system are in transport position before the operator starts driving, and also during the transport.

A device installed in the dashboard of the truck Transport Reporting Interface (TRI) warns the driver with a visible and audible signal of an incorrect position during the transport:

- Red warning light (1) on: the height of the crane exceeds a set maximum value.
- Red warning light (2) on: at least one of the stabiliser extensions is not in transport position.
- Buzzer OFF button (3).
- Green warning light (4) on and the rest of the lights off: the crane and stabiliser system is in transport position and the vehicle is ready to move.
- The buzzer (5) sounds if one or both warning lights (1) and (2) are active.

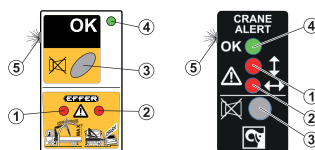
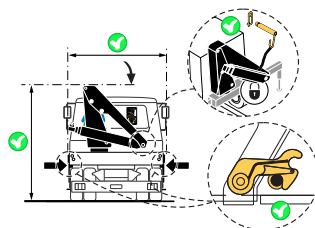

NOTE

- During the crane operation, the red lights are lit and the buzzer is active. You are able to turn off the buzzer by pushing the button (3).
- If you are driving the vehicle and the height of the crane or the stabiliser extensions change from the transport position, the system gives a warning in the cab.



CAUTION

- Do not move the vehicle if you see or hear the warning on the TRI.
- Stop the vehicle immediately if the visual alarm / sound is active while driving:
 1. Switch on the system.
 2. Operate the boom system and the stabiliser extensions to their transport position.
 3. Make sure that the locking devices are in good conditions and in place.
 4. Switch on the system.
 5. If you can still see/hear the warning, secure the crane and the stabiliser system positions and go immediately to an authorised service workshop.



DANGER

- After use, always put the crane into the transport position!
- When you have to park the boom system on the truck body (if designed by the installer), secure the boom system and the lifting accessories to prevent any unintentional movement of the crane and the lifting accessories.

8. Maintenance and Service

8.1. Service

No welding/drilling work on the crane



DANGER

- Do not do any welding work on the crane. Welding work on the crane may only be carried out by an authorised service workshop.
- Do not drill into the crane yourself. Drilling work on the crane may only be carried out by an authorised service workshop.
- Never try to reinstall the crane. Only an authorised Installer may reinstall the crane.



Disconnecting hydraulic lines for accessories

You can disconnect a hydraulic line or a hose only for specific operator's tasks (for example, disconnecting the interchangeable equipment).

1. Make sure that the cylinders are not at the end of stroke and minimise as much as possible the forces acting on them.
2. Switch off the system.
3. Disengage the PTO.
4. Make sure that you wear the correct personal protective equipment.
5. Slowly loosen all connectors.

Leakages



DANGER

- STAY AWAY from oil leaks in the hydraulic system! Oil in the hydraulic system is under high pressure, can spill, be very hot and cause you injury.
- Do not replace any hydraulic hoses or lines yourself.

Deal with an oil leak as follows:

1. Rest the crane on the floor or on the truck platform.
2. Switch off the control system.
3. Disengage the PTO.

Leaking coupling:

- a. Do not tighten the coupling with a spanner. You could damage the O-ring of the coupling.
- b. Contact an authorised service workshop.

Small leak on a line or hose:

- a. Determine if you can still park the crane.
- b. If you can, park the crane and go to an authorised service workshop.
- c. If you cannot, contact an authorised service workshop.

8.2. Warranty

The Seller only provides Warranty if the conditions specified in the "Service and Warranty Manual" are fulfilled.

Refer to the Service and Warranty Manual of your Product.

8.3. Follow the maintenance instructions!

Take the crane to an authorised service workshop for inspection and maintenance. Maintain lifting accessories and interchangeable equipment according to the supplier's instructions.

**WARNING**

- Make sure that faults in the crane are corrected immediately!
- Never correct faults yourself that may only be corrected by an authorised service workshop.
- Carry out yourself only the service and maintenance work you have the requisite knowledge and experience for. Maintenance must be performed by qualified personnel.
- Always use personal protection devices and other safety means during the maintenance work in compliance with the regulations of the country in which you use the crane.
- All personnel must understand and comply with all warning and instructional decals attached to the body, crane and truck controls.
- Mark out the working area and make sure that there are no unauthorised persons inside.
- NEVER walk or stand under a crane or a suspended part. People may suffer fatal crushing injuries!
- When working on any part of the crane, put the "Out of Service" tags displayed clearly and wherever possible on the vehicle, and remove the ignition keys to prevent accidental operation.

**NOTE**

- Make sure that you have read the complete manual before starting the preventive maintenance. It provides detailed information about the maintenance process.
- Make sure that the manual and other documentation are in good condition, near the machine and available for anyone who needs it.

Maintenance intervals:

- Carried out by the **operator: daily and monthly inspection.**
- Carried out by an authorised service workshop:
 - **1st service:** to be made after 50 hours of use.
 - **Regular service:** to be made when one of these conditions are met:
 - 1,000 hours of use
 - 365 days



NOTE

These maintenance intervals could be needed more frequently if the use of the crane is in special conditions (high amount of cycles, heavy loads, etc...) and/or hard environmental conditions (deserts, mines, etc...). Please, contact your Effer representative.



NOTE

An indicator on the display panel shows that the 1st service or regular service must be carried out.

When the alarm is active, the buzzer generates 4 beeps every 20 minutes.



NOTE

Refer to the "Service and warranty manual" to know the actions performed by the authorised service workshop.

Long storage of the crane

If you need to store your crane for a month or longer, do this first:

1. Clean it according to the instructions in the section "Cleaning" of this manual.
2. Lubricate it according to the lubrication schedule of this manual.
3. Put the crane into transport position and disconnect the power from the vehicle battery.
4. Put grease on the exposed piston rod(s) and the external seals of the hydraulic cylinders.
5. Put a plastic cover on the crane.
6. Protect it from rain, sun and dirt as much as possible.

Cleaning

Clean your crane regularly, but:

- Always set the power off before you start.
- Do not use aggressive cleaning agents.
- If you use a high pressure water jet, make sure that:
 - Temperature of the cleaning water is between 50°C-60°C.

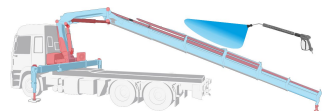

- Maximum working pressure is 150 bar.
- Minimum distance between the nozzle and the surface to clean is 80 cm.

**CAUTION**

Never use a high pressure water jet on electronic parts, hose reels, cable reels, plastic components, signs, bearings, control valves, cylinders or the oil tank. Only the cranes surface may be cleaned with a high-pressure jet cleaner.

**NOTE**

Always lubricate after cleaning the crane.

**WARNING**

Keep the devices to go into the control station (handles, supports, platforms...) clean from oil, grease and dirt to prevent slipping and falling.

8.3.1. Daily inspection

**NOTE**

Refer to the daily inspection checklist at the end of this manual to photocopy.

Presence of signs and symbols

- See chapter "Safety precautions and warnings" under section "Signs on the crane". Make sure that all the signs shown in section "Signs on the crane" are in position and in good condition.
- Make sure that all the symbols on your crane are in good condition.

Locking devices

- Make sure that all locking devices are undamaged and working properly.
- Make sure that all locking devices are properly locked.

Spirit level

- Make sure that the spirit level is clearly visible to the operator and works correctly.

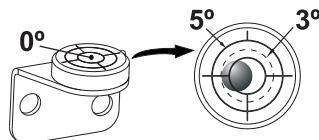

Shafts, shaft locking, bearings and bushings

- Check that the shafts, shaft locking, bearings and bushings are undamaged and working properly.



DANGER

In the event of damage that presents a safety risk:

- Do not use the crane.
- Have the damage repaired immediately by an authorised service workshop.

Hooks

Always keep the hook clean. Use a cloth to wipe away any dirt.

Non swivel hook

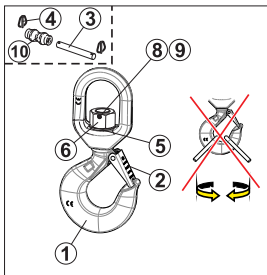

Swivel hook with bearing

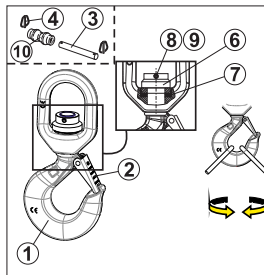

Swivel pot hook

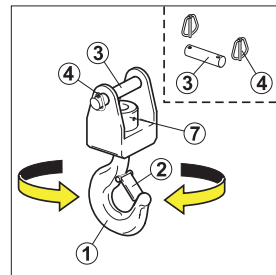

Before every working shift:

- Do an inspection of the general conditions of the Hook (1) for deformation (stretched, cracked, twisted, excessive wear...) and surface damages with significant depth (such as from chemicals or heat).
- Do an inspection of the clevis/link shaft (3) and/or centring spacer (10) for damage/deformation.
- Do an inspection of the two Spring/Roll pins (8) and (9) that are in place and properly retaining the central hook nut (6).
The two Spring/Roll pins (8) and (9) should be in place and nearly flush with the outer edge of the hook nut (6) on both sides.
- Do an inspection of the spring-loaded safety Latch (2). The Latch must close the entire throat opening.
- Verify that the clevis/link Shaft (3) and/or centring spacer (10) and cotter/safety pin (4) are in place.
- Verify that the plane bearing/washer (5) or the swivel (7) is in good condition.
- Do a general inspection for deformation and operation of the remaining items: clevis, swivels, washers, nuts...
- Lubricate the hook according to the chapter "Lubrication of the hooks".



DANGER

In the event of damage or worn to prevent a safety risk:

- Do not use the hook.
- Have the damage repaired immediately by an authorised service workshop.

Lifting accessories, interchangeable equipment and optional crane components

- Check the cables, cable connections, the cable guides and the attachment points.
- Check the rope, rope connections, the rope guides and the attachment points.
- Maintain all lifting accessories, interchangeable equipment and optional crane components according to the instructions supplied with them.

Electronic components

- Make sure that all sensors, microswitches, solenoid buttons etc. are in perfect condition, correctly mounted and the connection cables are not damaged.
- Make sure the moving parts of microswitches are clear from mud and dirt.
- Make sure that the horn works correctly.
- Make sure that the display or LEDs on the user interface are working correctly.

Hydraulic system and oil level in the tank

- Check that there are no leaks from the hydraulic hoses, lines and connections.
- Make sure that all security seal wires (Ex. LHV, dump valves, etc...) are not broken. Always go to/contact an authorised service workshop when the seal wire has been broken.

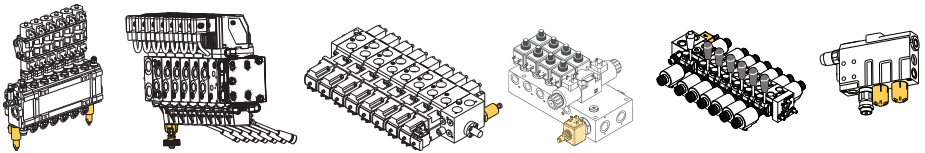
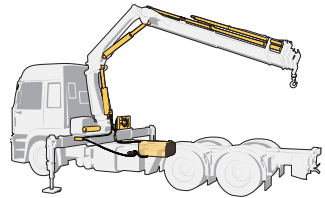

- Check oil level in the tank. If necessary, fill to correct level.



NOTE

Always place the vehicle on level ground with the crane in transport position while checking the oil.

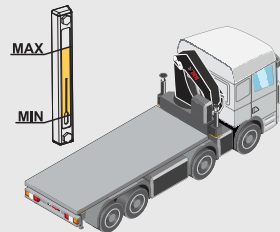

Slewing motors condition

- Make sure that the slewing motors with the base attachment screws/bolts are not broken or loose. Check that they are in good condition and in place.

**DANGER**

If you find broken or loose bolts:

- Do not use the crane.
- Have the damage repaired immediately by an authorised service workshop.

Filters

- Always check the filter indicators when the crane is in working conditions. If it indicates that the filter is clogged, a workshop must replace the cartridge.

8.3.2. Monthly inspection and maintenance**NOTE**

Refer to the monthly inspection checklist at the end of this manual to photocopy.

In addition to the daily inspection, carry out the following tasks each month:

Piston rods

- In cases where the cylinder piston rod is exposed to pollution due to the parking location, the chromed surfaces must be cleaned and oiled to prevent corrosion. This needs to be done regularly.

Pivot pins and bushes

- Inspect all the pivot pins and bushings for the crane boom and cylinders for damage, clearance, etc.

Bolts and screw fixings

- Check that bolt and screw fixings are tight. If not, contact an authorised service workshop
- Make sure that the fixing bolts and hoist screws are not broken or loose. Check that they are in good condition and in place.

Cables and sensors

- Check that cables and sensors are in good condition.

Lubrication schedule

- Carry out the lubrication according to the instructions.

Slewing bearing / upper column bearing

- Check that the slewing bearing / upper column bearing is lubricated sufficiently.

Oil level in the slewing motors

- Do a check of the oil level in the gearbox of the slewing motors. If necessary, fill it to the correct level.

Hydraulic system

- Check that the hydraulic pump attachment screws are tightened.
- Check if the oil in the hydraulic system needs to be changed, or have it tested by a workshop or a specialist.

Lifting accessories, interchangeable equipment and optional crane components

- Maintain all lifting accessories, interchangeable equipment and/or optional crane components according to the instructions supplied with them.

Paint condition

- Check that there is not any paint damage on your crane. Have the damage repaired immediately by an authorised service workshop.

8.3.3. First check

The 1st Service is carried out by an authorised service workshop after the first 50 working hours of the crane.



NOTE

Refer to the “Service and warranty manual” to know the actions performed by the authorised service workshop.

8.3.4. Annual maintenance

Take the crane, at least once a year, to an authorised service workshop for inspection and maintenance.

The workshop must carry out the following maintenance tasks at least once a year.

Hydraulic oil

- Change the hydraulic oil.



NOTE

If the workshop is equipped and personnel prepared to do a test of the oil quality and think that the oil change is not needed, they can postpone it on their own responsibility.

Oil in the slewing gearboxes

- Change the oil in the slewing gearboxes, or have it tested by a workshop or a specialist.

Hydraulic system and oil-tank filler cap

- Change the filler cap.
- Replace filters.

Hooks

- Replace missing or faulty parts on link assembly: shafts, safety pins and nuts.

- Replace the hook for a new one if the hook is damaged.
- Replace the hook for a new one if its weight allowed marking is damaged.
- Replace the latch assembly if it is damaged, missing or malfunctioning.
- Replace the hook for a new one if the clevis/link shaft, centring spacer, or split clevis retaining nuts are missing or damaged.
- **Non swivel hook:** replace the two spring/roll pins and the plane bearing with new ones at least once a year.

Slewing bearing

- Make sure that there are not unusual movements, noises, excessive clearance, etc... between the base and column when operating the crane.
- Make sure that the base with the column attachment (screws/bolts) are not broken or loose. Check that they are in good condition and in place.
 - External screw/bolts (1).
 - Internal screw/bolts (2), remove cover (3) and check the fastening bolts through the hole.

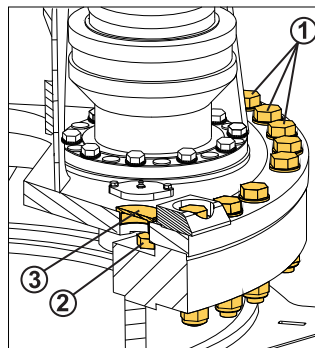

DANGER

If you find broken or loose bolts:

- Do not use the crane.
- Have the damage repaired immediately by an authorised service workshop.



WARNING

Effer strongly recommends doing this inspection every 6 months by an authorised service workshop.

8.4. Lubrication

8.4.1. General greasing of the cranes

Incorrect or insufficient lubrication of a crane is the number one cause of premature failure.

Lubricate all parts in the crane marked with the symbol 



WARNING

Before and after a long stop of the crane, lubrication is necessary (especially after a winter shutdown).



WARNING

Follow the lubrication schedule exactly. If you do not do so, you can cause serious damage to the crane, interchangeable equipment and/or optional crane component, if mounted.



Procedure:

1. Shut down the crane.
2. Make sure that all the lubrication points are clean before lubricating. Dirt can damage the parts.
3. Lubricate all points in each section.
4. Operate the crane through the full cycle for each section. Moving the lubricated parts is very important to get the full and correct lubrication of all moving components.
5. Shut down the crane and repeat the lubrication.
6. Lubrication is finished when the grease spills out from the ends. Clean the excess grease.



WARNING

Personnel must not try to work on a moving/activated crane as there is a risk of serious injury or death.

You will need different tools based on the area to lubricate: a pressure grease pump , an oiler , a brush .



CAUTION

When you use pressure grease pumps, open the plastic safety guard of the nipple and close it at the end.

Greases

- Use molybdenum-disulfide grease (for bronze-made components).
- Use lithium-based grease AGIP MUEP2 or equivalent, for the booms, JIB, and stabiliser extensions.



CAUTION

Do not mix greases with different characteristics. If you change from one kind to another, fully remove the old grease by applying a large quantity of the new one.

Recommended greases:

Use Nillex 2 (Nils) or grease type NILS ATOMIC RH for cranes equipped with centralised or automatic greasing system.

Alternative:

FUCHS LUBRITECK: STABYL AX 2, AGIP: ROCOL SAPPHIRE AQUA 2, AGIP: AC 2.

Lubricating oil:

For oil lubrication, use class SAE 30 (maximum ambient temperature 20 °C) and class SAE 90 (for ambient temperatures higher than 20 °C).

8.4.2. Lubrication schedule

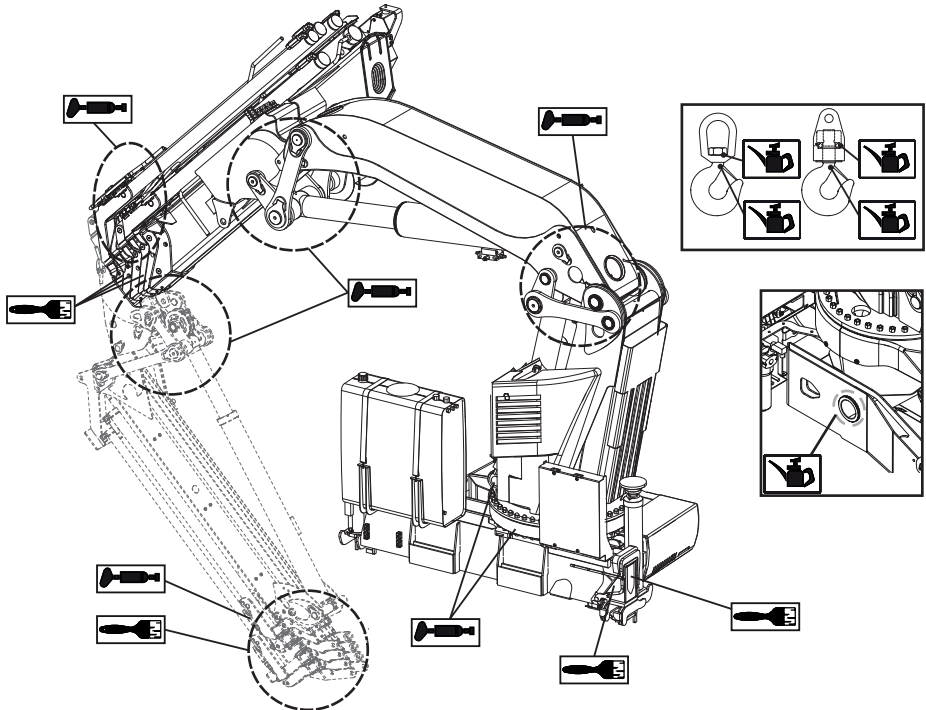

8.4.3. Central greasing system [option]



CAUTION

It is really important to make sure that the system works correctly. The central greasing system also needs maintenance.

This system has all the greasing points of the column, 1st boom and 2nd boom collected in a centralised manifold. It does not include the stabiliser system, the slewing bearing and the boom extensions.

Lines, Fittings, Manifolds, Injectors

Unfold the crane and do an inspection for broken plastic piping or damaged connectors and fittings.



CAUTION

The use of the wrong grease will void the customer's warranty and compromise the correct operation of the system. Refer to the section "General greasing of the cranes".

8.4.4. Lubrication of the slewing bearing and the bearing assembly

Slewing bearing

1. Remove the cover (1).
2. Put grease on the teeth on the slewing bearing with a brush through the hole (2).
3. Slew the crane a bit and put grease again.
4. Make sure that the slewing bearing is fully greased.
5. Install the cover again in the same direction.

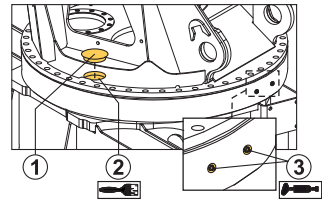

Bearing assembly

The grease filling is there to reduce friction, seal the bearing and provide protection against corrosion.

- The operator has to grease the bearing assembly approximately every 100 working hours.
- Lubrication is made by injecting approximately 5 cm³ into each grease nipple (3) around the bearing.

8.4.5. Lubrication of the boom system

Clean the surfaces and remove with a spatula all abrasive material (dirt, sand, shavings), and where possible, the old grease.

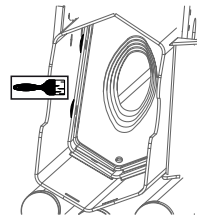
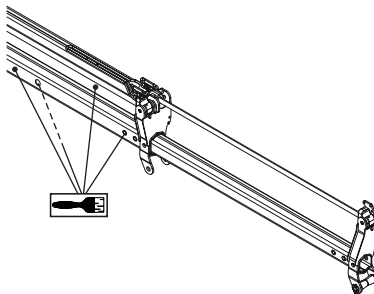

Procedure:

- Grease externally the extensions in the low part (less in the upper and side parts).
- Grease internally the extensions in the upper part (less in the lower and side parts).
- In order to internally grease, use the side holes in the extensions (if fitted) and the back closing plate slots.
- Grease the sliding block area (if fitted) with the extensions retracted and also through two specific greasing points.



NOTE

To prevent or correct malfunctions or the "stick-slip" of the boom extensions operation, we recommend lubricating the lower part of the extensions.

If you have any doubt, please contact your Effer representative.

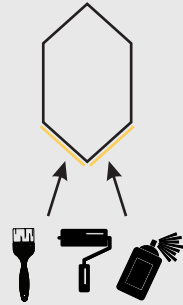

8.4.6. Grease on the stabiliser extensions

Grease the lower sliding surfaces on the stabiliser extensions.

When accessible, grease inside the stabiliser beam in the upper and lower sliding surfaces.

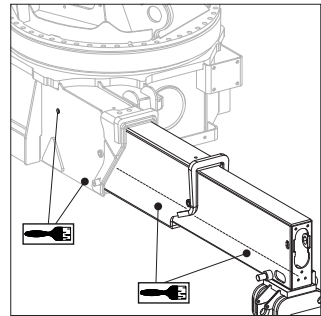

8.4.7. Lubrication of the hooks

Hooks with plane bearing

1. Lubricate with oil the spring of the latch.
2. If the hook cannot rotate easily without load, grease the plane bearing surfaces.
Use a heavy duty penetrating spray grease, type "ZEP 2000" or equivalent quality.

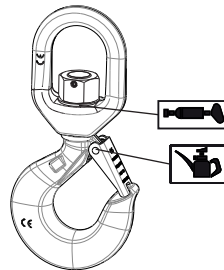

Hooks with swivel

1. Lubricate with oil the spring of the latch.
2. If the hooks cannot rotate easily with load, grease the swivel bearing.
Use a bearing grease, type "Texaco Multifak EP 2" or equivalent quality.

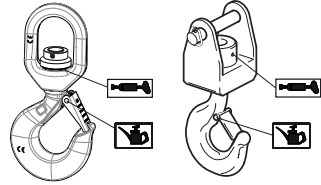

8.5. Checking and topping up oil levels

8.5.1. Slewing motors gearbox

Supplier recommendation:

Have the oil changed approximately every 2500 operating hours.

Recommended oil:

Use a hypoid oil, type API GL-5, SAE J2360 (Formerly MIL-L-2105), viscosity SAE-80W-90, cleanliness NAS 1638:8. For example: "ENI ROTRA MP 80W-90", "SHELL SPIRAX S2 A 80W/90" or equivalent quality.



CAUTION

The oil used for filling must be clean. Do not mix different oils (a mixture will change the oil properties).

Oil level checking and top up

1. Remove the plug (1).
2. Check if there is enough oil.
3. If there is no oil, top up with oil till it comes out of the motor.
4. Mount the plug (1).

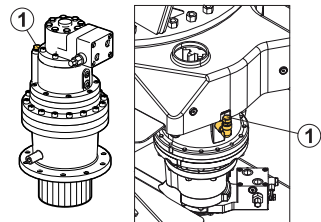

8.5.2. Oil tank / Hydraulic oil

Checking of the oil level of the tank

1. Place the crane and stabiliser legs in the transport position.
2. Place the vehicle on level ground.
3. Check the oil level in the tank.
4. If the oil level is too low, top up with hydraulic oil.

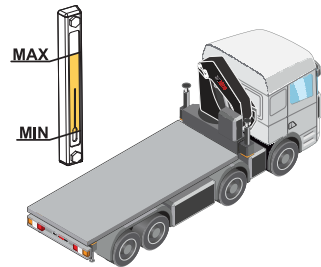

Oil filling / Top up

1. Make sure that the required equipment to fill the tank is fully clean.
2. Put the crane in the parked position.
3. Clean the area around the oil filler cap.
4. Fill with oil up to the max level indicator.

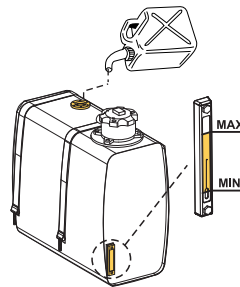

CAUTION

- Never fill the tank completely, because during operation the volume of the oil could expand as the temperature increases.
- Never use recycled oil!

Filling the oil tank with hydraulic oil



CAUTION

The oil used for filling must be clean. Do not mix different oils (a mixture will change the oil properties).

Hydraulic oils must have been dealt with according to cleanliness requirements ISO 4406: -/16/13.

Hydraulic oil that is approved for EFFER products must comply with one of the following standards or equivalents:

- DIN 51524 part 2HLP
- ISO L-FD
- ISO L-HM

Verify with the supplier that the quality and performance of the hydraulic oil complies with the previous standards.

When changing from mineral oil to a non-polluting synthetic oil, or when changing to biodegradable oil, contact an authorised service workshop.

Recommended hydraulic oils

	ISO VG 32	ISO VG 46	ISO VG 68
Examples	Tellus S2 V32 Super 32 Hydrol L-HV 32	Shell TELLUS T 46 Texaco RANDO HDZ46 Agip ARNICA 46	Mobil SHC 526
Where to use them			

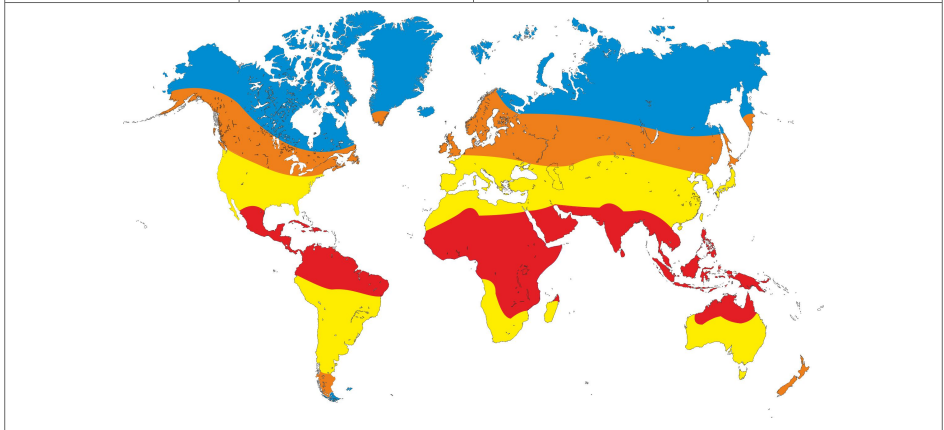

Viscosity of oil

The viscosity of the oil is of great importance to achieve high efficiency of the hydraulic system.

The naming of the oil in the table below: 32, 46 or 68 tells the viscosity of that oil at 40°C (104°F) (reference temperature).

Viscosity of oil at 40°C (104°F)	Temperature range
32	-25°C to 75°C (-13°F to 167°F)
46	-15°C to 90°C (5°F to 194°F)
68	-5°C to 90°C (23°F to 194°F)

The recommended viscosity during normal working conditions is between 20 and 70 cSt.

Effer strongly recommends an oil working temperature below 80°C (176°F). If necessary consider an extra oil cooler or heater.



NOTE

If you need to work at a temperature below -25°C (-13°F), contact an authorised service workshop.

Environmentally Friendly Oil

The environmentally friendly oils recommended for EFFER products are ester based synthetic hydraulic fluids (synthetic ester).



CAUTION

Vegetable oils do not meet Effer requirements and must not be used.

After filling the tank

1. Operate each crane function to its end positions.
2. Put the crane into parked position.
3. Check and top up the oil tank to max level on the tank gauge.
4. Bleed the air from the hydraulic system.



NOTE

- Ensure the waste oil is disposed of safely and in accordance with local environmental regulations.
- The oil can be hot and cause injury.

8.5.3. Bleeding air from the hydraulic system

Bleed the air from the hydraulic system:

- after changing the hydraulic oil
- after working on the hydraulic system
- if your crane works slowly or jerkily
- if your crane has not been used for a long time



WARNING

Air in the hydraulic system can lead to faults and damage

To bleed the air from the hydraulic system, proceed as follows:

1. Slowly extend and retract each stabiliser extension to its end position at least two times.
2. Slowly extend and retract each stabiliser leg to its end position at least two times.
3. Set stabiliser system in working position and operate the crane out of parked position.
4. Slew the crane slowly.
 - If your crane has a rack-and-pinion slewing system, slew the crane in each direction to the slewing stop at least twice.
 - If your crane has a continuous slewing system, slew at least two complete rotations.
5. Slowly raise and lower the 1st and the 2nd boom to its end position at least twice.
6. If the crane is equipped with JIB, slowly raise and lower the JIB at least twice with main boom system pointing downwards and upwards.
7. Slowly extend and retract the boom extensions to their end position at least twice.
 - a. If your crane is equipped with JIB, extend and retract the 2nd boom extensions with the JIB pointing almost vertically upwards and downwards.
 - b. Slowly extend and retract the JIB extensions to their end position at least twice.

8. Slowly operate each hydraulically operated interchangeable equipment and/or optional crane components to their end position at least two times.



CAUTION

Do not keep the lever engaged at the end position of each movement.

9. Check the oil level in the tank and top up if necessary.

8.6. Replacement of filters

Filter cartridges must be replaced by an authorised service workshop.

- after the first 50 hours operation
- then after every 1000 hours operation
- or at least once a year.



CAUTION

Dirt will damage the hydraulic system.

8.6.1. High pressure filter

A device inside this filter detects if it is clogged. If so, you will hear a sound warning for 30 seconds every time you switch on the crane, and you will see the code '*WN025 oil filter full*' on the display panel and on the controller until the filter cartridge is replaced.

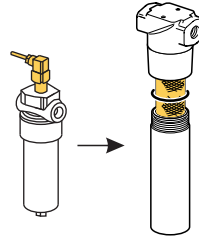

NOTE

When you replace the cartridge, on the display panel go to the main menu 'Access maintenance', select 'Oil Filter Changed' and click on confirm.



8.6.2. Return oil filter with clogging indicator

- When the clogging indicator turns red or filter time is reached (whichever is the sooner), the cartridge must be replaced.
- If the indicator is not installed, replace the cartridge periodically as recommended by Effer.

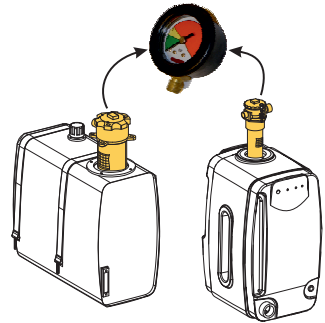

8.6.3. Breathing filter

This filter has no indicator. The location is in the filler cap in the oil tank.

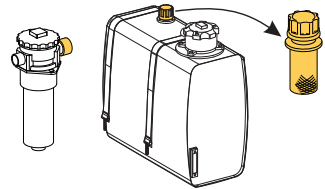

9. Decommissioning

9.1. Decommissioning a crane



NOTE

Only qualified companies can remove the crane from the truck and dispose of it.

Cranes are designed and manufactured taking the environment into consideration. Environmental requirements and soundness have been considered when selecting the raw materials. The metal parts are designed to achieve a light and durable construction; this includes the selection of higher-quality grades of steel. When the crane is decommissioned at the end of its service life, years from now, waste will be created, which must be utilised and disposed of correctly. The crane must be decommissioned properly. Most of the crane's raw materials can be recycled.

Follow the regulations of the local authorities!

- Oil and grease must not be spilled on to the ground or released into the environment!
- Drain the oil from hydraulic cylinders, valves and hoses.



Sort the waste

- Deliver the metal parts for recycling, for reuse as raw material. These are load-bearing, structures manufactured from steel or cast iron, hydraulic cylinders and lines drained of oil, directional control valves, shafts, bearing bushes, control levers, small parts.

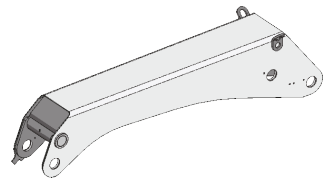

Energy waste can be utilised by incinerating it at a proper waste incineration plant.

- Spiral wraps, manufactured from polyethene, plastic, bearings (cleaned of lubricants) used in the column, beam system etc, manufactured from polyamide plastic.

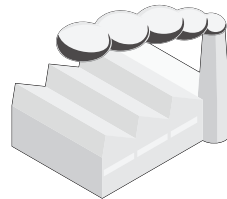

Unsorted waste should be delivered to a landfill.

- Drained hydraulic hoses, electrical wires, control cables, seat, hydraulic cylinder seals, lights, small plastic and rubber parts.



Hazardous waste is delivered to a collection point for hazardous waste.

- Oils: hydraulic oil, transmission oil from the slewing system
- Solid lubricants: greases from the joints and journal bearings
- Other waste containing oils and greases: hydraulic oil filters.



European Union—Disposal Information

This symbol identifies the parts of your crane that need to be disposed of separately from household waste according to EU legislation. When one of these parts reaches the end of its life, take it to a collection site designated by local authorities. Responsible collection and recycling help protect natural resources, the environment, and human health.



Stability diagrams

The Installer must deliver the stability diagrams to the operator for cranes with Progress or SENSE feature.

- **Cranes with Progress:** the installer deliver the stability diagram represented with 4 working areas and different positions of the stabiliser extensions.

- front
- right side
- rear
- left side

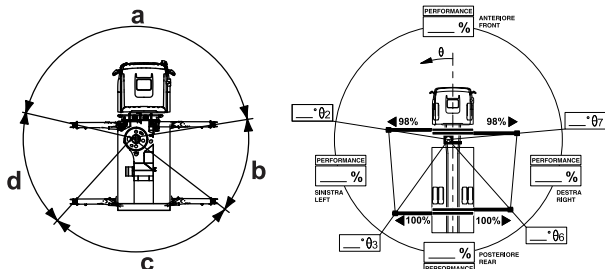

- **Cranes with SENSE:** the installer deliver the stability diagram represented with 360 working areas, one for each degree of the crane slewing area, and different positions of the stabiliser extensions. They can also supply different lifting capacity diagrams/tables according to the operator's needs.

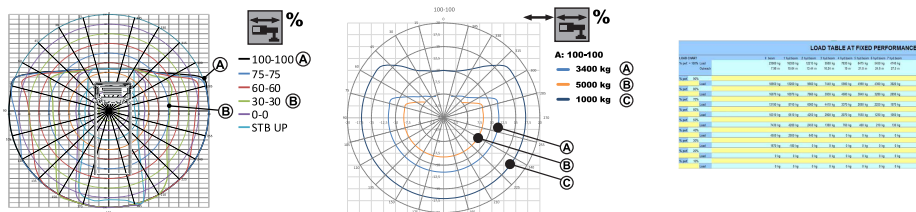

10.2. Identification of the loader crane

The information below is to be filled in by the installer. The same information will be found on the serial number plate on the crane:

Mark: EFFER

(0) Machine Type: CRANE

(1) Model:

(2) Serial number:

(3) Manufact. year:

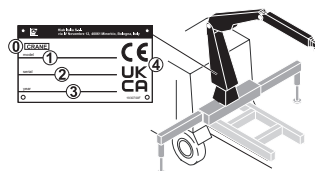

(4) CE mark / UKCA mark



10.3. Daily inspection checklist

Operator			Document ID:	
Crane s/n:			Date:	
DAILY INSPECTION	✓	✗	⊘	Comments
Presence of signs and symbols				
Locking devices				
Spirit level				
Shafts, locking shafts, bearings and bushings				
Crane structure				
Hooks				
Lifting accessories, interchangeable equipment and optional crane components				
Electronic components				
Security seal wires				
Hydraulic system and oil level in the tank				
Oil level in the slewing housing and condition				
Slewing motors condition				
Filters				
FUNCTIONAL TESTS				
Emergency stop buttons				
Levers on the controller				
Controller (Not warnings and/or faults)				
Horn and LED test				
TRI (Transport Report Interface)				
<p>If you find a fault that prevents you from operating the crane safely, contact an authorised service workshop. Do not try to repair the fault, it can cause you injury or you can damage the equipment.</p> <p>Permission to reproduce this checklist is granted; however please note that only the original document owned by Hiab will contain necessary amendments and updates. Hiab shall not be held liable if the copy in your possession does not contain the latest changes.</p>				

10.4. Monthly inspection checklist

Operator			Document ID:	
Crane s/n:			Date:	
MONTHLY INSPECTION				Comments
Piston rods				
Pivot pins and bushes				
Bolts and screw fixings				
Cables and sensors				
Lubrication schedule				
Slewing bearing / Upper column bearing				
Oil level in the slewing motors				
Pump attachment screws				
Gateway connectivity				

If you find a fault that prevents you from operating the crane safely, contact an authorised service workshop. Do not try to repair the fault, it can cause you injury or you can damage the equipment.

Permission to reproduce this checklist is granted; however please note that only the original document owned by Hiab will contain necessary amendments and updates. Hiab shall not be held liable if the copy in your possession does not contain the latest changes.