

# EFFER IQ.950-1200 HP



SPACE<sup>o</sup>E evo

**Operator's Manual GB**

737 4060





## **Congratulations!**

You are now the owner of a quality Product manufactured by Hiab (part of Cargotec Corporation).

The aim of this manual is to help you handle, maintain your crane safely and with full satisfaction.

This Manual provides detailed information about your Product, its control systems and its practical management and maintenance.

Please read the complete Manual carefully and make sure that you understand its contents. Please also carefully familiarise yourself with your Product before you start to use it.



Help us to improve this manual. Please send your comments and suggestions to **documentation@hiab.com**

This operator's manual is an Original Instruction and applies to cranes with the control system SPACEvo from serial number:

**9500001, 12000001.**

**2023-06**

This page is intentionally left blank.

# Table of Contents

1. Introduction .....	9
1.1. Target group and scope of this manual .....	9
1.2. The Machinery Directive 2006/42/EC .....	10
1.3. The Machinery (Safety) Regulations 2008 .....	11
1.4. Cleanliness certificate .....	12
1.5. Indications in the Operator's Manual .....	12
2. Structure and parts of the crane .....	15
2.1. Main groups .....	15
2.2. Crane base with column and slewing system .....	16
2.3. Stabiliser system .....	16
2.4. Boom system .....	16
2.5. Operating system - hydraulic components .....	19
2.6. LHV Load holding valves .....	20
2.7. Description of the loader crane .....	21
2.8. Available configurations .....	21
3. Safety precautions and warnings .....	23
3.1. Operating conditions .....	23
3.2. Wind speed .....	24
3.3. Definition of this loader crane .....	25
3.3.1. Noise declaration .....	26
3.3.2. Signs on the crane .....	27
3.3.3. Maximum load .....	27
3.3.4. Maximum load moment .....	30
3.4. Signals when using a crane .....	32
3.5. Use of the crane .....	35
3.5.1. Preparations for use .....	37
3.5.2. Crane operation .....	38
3.5.3. Driving with the crane .....	41
3.5.4. Use of lifting accessories and interchangeable equipment .....	42
3.5.5. Use of demountable cranes .....	43
3.5.6. Ending crane operation .....	43
4. The control system .....	44
4.1. Control System SPACEvo .....	44
4.2. How the safety system works .....	44
4.3. Components of the control system .....	45
4.4. Standard symbols and functions of the crane and the stabiliser system .....	45
4.5. Main control valve .....	48
4.6. Different stabiliser control valves .....	48
4.7. User Interface (UI) .....	49
4.7.1. Buttons on the User Interface .....	49
4.7.2. Indicator LEDs on the User Interface .....	49
4.8. Dump valves .....	52
4.9. Pressure-reducer filter .....	52
4.10. Warning LED lamps .....	52
4.11. CombiDrive controller .....	53
4.11.1. Cable connection [option] .....	53
4.11.2. Lights and vibration on the controller .....	53

---

4.11.3. CD4 displays .....	54
4.11.4. Buttons .....	56
4.11.5. Operational VIEWS, standard functions and symbols .....	57
4.11.6. Battery and battery charger .....	65
4.12. Other components of the control system SPACEevo .....	66
5. Starting crane operation .....	68
5.1. Starting operations .....	68
5.2. Set the stabiliser system .....	70
5.2.1. Stabiliser system and ground conditions .....	72
5.2.2. Activate the stabiliser system .....	74
5.2.3. Extend the stabiliser extensions .....	75
5.2.4. Set the stabiliser legs .....	76
5.3. Operate the boom system out of transport position .....	79
5.3.1. SAF Semi Automatic Folding [option] .....	80
5.3.2. BDA Boom Deployment Assistance [option] .....	81
5.3.3. Operate the boom system .....	82
6. During operation .....	83
6.1. Features .....	83
6.1.1. Controlling the crane speed with the controller CombiDrive .....	83
6.1.2. Supervision of spools .....	84
6.1.3. APO Automatic power off .....	84
6.1.4. ADO Automatic Dumping of Oil .....	84
6.1.5. ASC Automatic Speed Control .....	84
6.1.6. ADC Automatic Duty Control .....	85
6.1.7. PFD Pump flow distribution .....	85
6.1.8. VSL Variable Stability Logic .....	85
6.1.9. VSL+ (Variable Stability Logic Plus) [option] .....	90
6.1.10. LSS-V Load stabilising system-vertical [Option] .....	91
6.2. OLP Overload protection .....	92
6.3. OLP - indications on the controller .....	93
6.4. To release OLP .....	94
6.5. Hydraulic connections .....	95
6.5.1. Hydraulic quick couplings [option] .....	95
6.5.2. Hydraulic quick couplings (MULTI-X) [option] .....	97
7. Ending crane operation .....	98
7.1. SAF Semi Automatic Folding [option] .....	98
7.2. Operate the boom system into transport position .....	100
7.3. Placing the stabiliser system in the transport position .....	102
7.4. Switching off the control system .....	106
7.5. Emergency operation .....	106
7.5.1. EMERGENCY operation to bring the crane to transport position .....	106
7.5.2. EMERGENCY operation to bring the stabiliser system to transport position .....	108
7.5.3. Separate emergency lever [option] .....	109
7.6. Transport warning .....	110
8. Maintenance and Service .....	112
8.1. Service .....	112
8.2. Warranty .....	113
8.3. Follow the maintenance instructions! .....	113
8.3.1. Daily inspection .....	115

---

---

8.3.2. Monthly inspection and maintenance .....	120
8.3.3. Annual maintenance .....	120
8.4. Lubrication .....	122
8.4.1. Lubrication schedule .....	123
8.4.2. Greasing the slewing bearing (internal gear teeth) .....	124
8.4.3. Greasing the bearing assembly (raceway and inner balls) .....	124
8.4.4. Greases for the slewing bearing and the bearing assembly .....	125
8.4.5. Lubrication of slide pads in the boom system .....	125
8.4.6. Lubrication of the hooks .....	126
8.5. Checking and topping up oil levels .....	126
8.5.1. Slewing motors gearbox .....	126
8.5.2. Checking of the oil level of the tank .....	127
8.6. Replacement of filters .....	129
8.7. Bleeding air from the hydraulic system .....	130
8.8. Troubleshooting .....	131
8.8.1. Main fuses .....	131
8.8.2. Faults on the crane .....	132
8.8.3. Display .....	136
8.8.4. Gateway connection box [option] .....	137
9. Decommissioning .....	140
9.1. Decommissioning a crane .....	140
10. Technical Data .....	142
10.1. Load plate table .....	142
10.2. Identification of the loader crane .....	143
10.3. Daily inspection checklist .....	144
10.4. Monthly inspection checklist .....	145

---

This page is intentionally left blank.



# 1. Introduction

## 1.1. Target group and scope of this manual

### This manual describes:

- Operation
- Safety precautions and warnings
- The crane control system
- Maintenance and troubleshooting

### Enclosed to this manual the Installer will provide:

- Technical Data for your crane
- Technical Data and manuals for interchangeable equipment if fitted

### Study these instructions carefully and keep them



#### **DANGER**

If you do not study the complete Operator's Manual for your crane carefully, it could lead to fatal accidents or serious damage.



#### **NOTE**

Keep these instructions for future reference.

### Therefore you should:

- Study the entire Operator's Manual carefully.
- Study the operating manuals for other interchangeable equipment and/or optional crane component, if fitted.
- Use the crane only after having done so.
- Follow the directions for use, operation and maintenance of the crane, interchangeable equipment and/or optional crane component exactly.
- Store the Technical Data and manuals from the Installer, together with this Operator's manual.





- Name and address of the person authorised to compile the technical file (4):  
Name  
Address
- Identity and signature of the person who drawn up the declaration (5):  
Name  
Position  
Date and Signature



### 1.3. The Machinery (Safety) Regulations 2008

- The Declaration of Conformity, delivered with the crane contains (1):
- Business name and full address where the crane is manufactured (2):  
Factory addresses:  
Hiab Cranes S.L.U. Pol. Ind. Malpica, calle E, 86 50016 Zaragoza, Spain  
Cargotec Poland Sp. z o. o. Ul. Metalowa 2, 73-102 Stargard, Poland  
Hiab Italia S.r.l. Via IV Novembre 12, 40061 Minerbio (BO), Italy
- Description and identification of the loader crane (3):  
Mark  
Type: see chapter Identification of the crane.  
Serial number  
Manufact. year  
Declaration of which provisions the loader crane fulfils.
- Name and address of the person authorised to compile the technical file (4):  
Name  
Address
- Identity and signature of the person who drawn up the declaration (5):  
Name  
Position  
Date and Signature

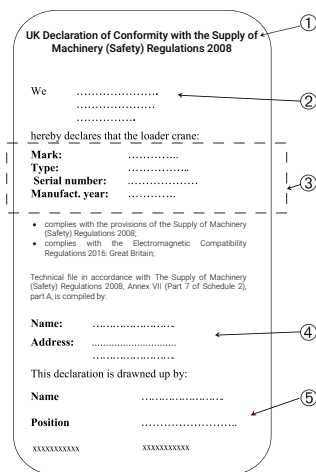

UK Declaration of Conformity with the Supply of Machinery (Safety) Regulations 2008

We ..... ②

.....

.....

..... hereby declares that the loader crane:

**Mark:** .....

**Type:** .....

**Serial number:** .....

**Manufact. year:** ..... ③

.....

- complies with the provisions of the Supply of Machinery (Safety) Regulations 2008;
- complies with the Electromagnetic Compatibility Regulations 2016 Great Britain;

Technical file in accordance with The Supply of Machinery (Safety) Regulations 2008, Annex VII (Part 7 of Schedule 2), part A, is compiled by:

**Name:** ..... ④

**Address:** .....  
.....

This declaration is drawn up by:

**Name** ..... ⑤

**Position** .....

XXXXXXXXXX XXXXXXXXXXXX



## 1.4. Cleanliness certificate

All Hiab equipment has been tested and certified at the factory according to the Hiab Standard C250.52 that defines the Cleanliness Requirements for Hydraulic Systems. This means that they fulfil the cleanliness class **20/18/14** measured by the ISO 4406 standard.

All hydraulic functions have been individually tested and fully comply with the defined requirements.



## 1.5. Indications in the Operator's Manual

Please pay attention to the following instructions and use extra caution in these cases. Inform other users about these working safety symbols. In addition to the safety symbols and recommendations contained herein, the rules and regulations regarding safety and accident prevention of the country of application must be followed.

### What must you do and not do?

The following indications are used in the Operator's Manual:



#### **DANGER**

Danger to life for yourself or to bystanders.

Follow the instructions carefully!



#### **WARNING**

Danger of injury to yourself or to bystanders, or danger of serious damage to the crane or other objects.

Follow the instructions carefully.



#### **CAUTION**

Hazard for the crane or crane components. Follow the instructions carefully.

#### **Important:**

If actions are numbered, do them in numerical order!

1. Do this
2. Do that
3. ....



#### **NOTE**

Extra information that can prevent problems.

**TIP**

Tip to make the work easier to carry out.

### The symbol for reference to a component in an illustration.

(1) Refers to a component in an illustration.

[option]: Indication for parts that are not standard for the crane, but are optional. Not all options are available for your crane.

Illustrations used in this manual are for guidance only, and the illustrations are provided to help identify the general area of a crane/installation referenced in the text.

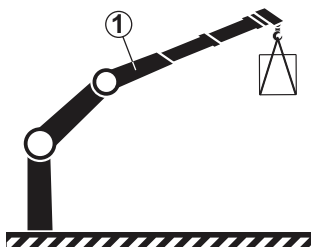
**DANGER**

Only persons with the requisite knowledge and experience with cranes may use the crane. Never operate the crane when you are sick, tired, under the influence of medicines, alcohol, or other drugs.

- Take the delivery instructions from your authorised service workshop, or receive instruction from an experienced person from your own company before you start to operate your crane.
- Make sure that you comply with the regulations of the country in which you use the crane (for example, certificate, safety helmet, and other personal protection devices).

**DANGER**

- Carry out yourself only the service and maintenance work you have the requisite knowledge and experience of.
- All other maintenance work may only be carried out by an authorised service workshop.
- Make sure that every defect is rectified immediately, according to the instructions.
- Follow the instructions exactly!
- Do not adjust/replace safety hydraulic/electrical components on the crane, as you can cause dangerous accidents. Only an authorised service workshop can do these actions.
- All other work to rectify faults must be performed by personnel in an authorised service workshop!

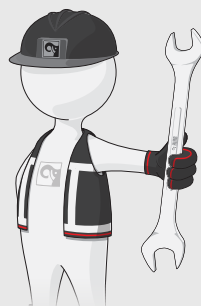

**WARNING**

- Never clean the electronic system, plastic components, signs, or bearings with a high-pressure jet cleaner. It could cause damage.
- Never expose the electronic system to high electrical voltages. This could damage the control system.
- Never immerse the controller in water or other liquid. This will make the controller unusable.

If your crane is equipped with interchangeable equipment and/or optional crane components (JIB, hoist, rotator, etc.):

- The operation of the crane with interchangeable equipment and/or optional crane components can differ from the operation as described in this manual.
- You should therefore study the Operating Manual for the interchangeable equipment and/or optional crane components carefully before you use the crane.
- Take particular note when placing the crane into or out of the transport position.

## 2. Structure and parts of the crane

### 2.1. Main groups

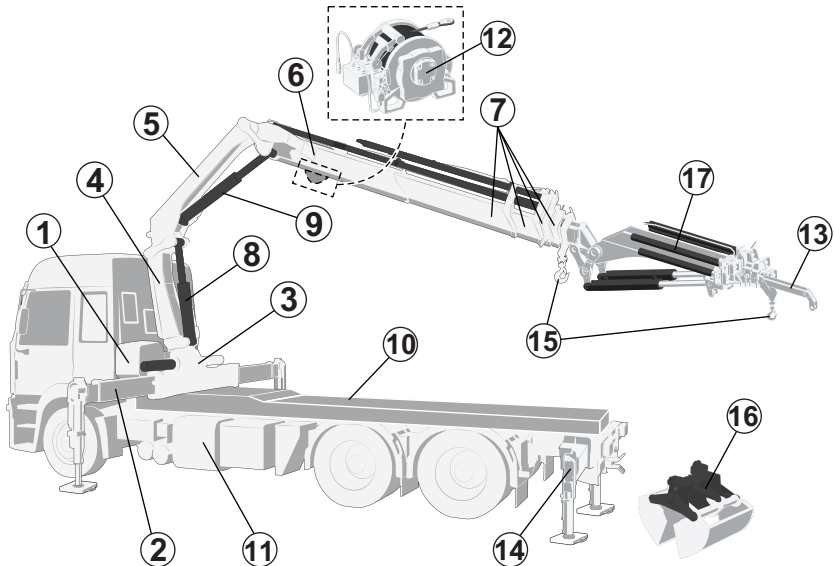

**This crane consists of the following main groups:**

- |                               |                       |   |
|-------------------------------|-----------------------|---|
| (1) Control station           | (6) 2nd boom          | (11) Oil tank                                     |
| (2) Stabiliser system         | (7) Boom extensions   | (12) Hoist [option]                               |
| (3) Base / Three-point bridge | (8) 1st boom cylinder | (13) Manual extensions [option]                   |
| (4) Column                    | (9) 2nd boom cylinder | (14) Auxiliary stabilisers (incl. front) [option] |
| (5) 1st boom                  | (10) Subframe         |   |

**Interchangeable equipment (e.g. grapple, clamshell bucket, pallet clamp, etc.), intended to be used on loader cranes can be attached depending on your crane configuration. Please refer to the operator's manual for the equipment.**

Some examples:

- (15) Hooks [option]
- (16) Grapple [option]
- (17) JIB [option]

## 2.2. Crane base with column and slewing system

The crane base, column and the slewing system consist of the following components:

- (1) Crane base:
  - with stabiliser beam (2).
  - with three-point bridge (3) or ready for bolted integrated subframe (6).
- (4) Column:
  - fitted to the crane base.
- (5) Continuous slewing system:
  - composed by a slewing bearing and 2 hydraulic slewing motors.

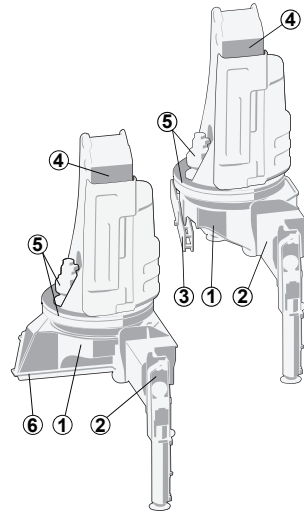

## 2.3. Stabiliser system

EFFER cranes (except stationary mounted) have two stabiliser extensions and two stabiliser legs. Auxiliary stabiliser systems may be needed for bigger cranes. The stabiliser system consists of:

- (1) Stabiliser beam
- (2) Stabiliser extensions
- (3) Stabiliser legs
- (4) Stabiliser locking devices [option]
- (5) Extra support plates

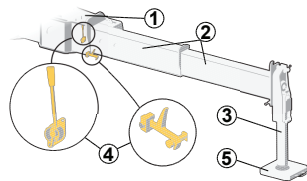

## 2.4. Boom system

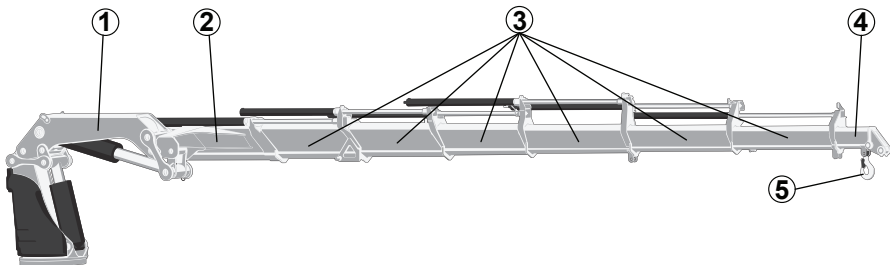

The boom system consists of the following main parts:



- (1) 1st boom
- (2) 2nd boom
- (3) Hydraulic extensions:  
The length of the hydraulic extension depends on the type of crane.
- (4) Manual extensions [option]

**And optional interchangeable equipment such as:**

- (5) Hook [option]
- Pallet fork, Grapple, Rotator, etc... [option]

## Manual extensions [option]

The manual extension is slid by hand into the hydraulic extension.

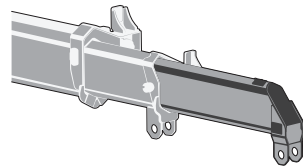

## Hoist [option]

The hoist is an optional crane component which permits load handling without any or only limited boom movement. An obvious advantage is that the hoist makes it possible to handle loads far below ground level.

Lifting and lowering is achieved by winding/unwinding the rope. A number of auxiliary components are needed, such as intermediate pulleys and a hook pulley. As an option, a snatch block can be installed to multiply the lifting capacity.

**The Hoist consists of the following components:**

- (1) Pressure roller
- (2) Wear pad (for rope-end-monitoring)
- (3) Rope
- (4) Load sensor
- (5) Cable (to load sensor)
- (6) Electronic box
- (7) Switch (for rope-end-monitoring)
- (8) Motor

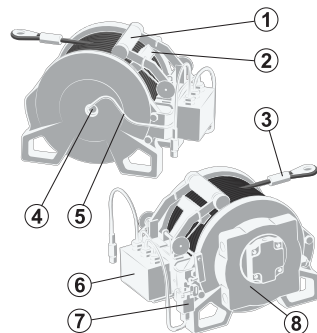

## JIB [option]

The JIB is an additional, folding, lifting device that extends the crane boom. Use the JIB to be able to reach further.

**The JIB consists of the following components:**

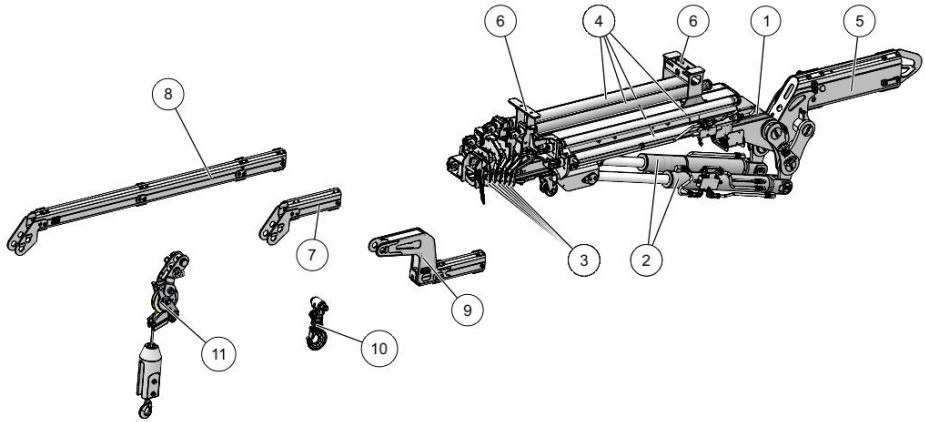

**Main components:**

- (1) JIB boom
- (2) JIB cylinder
- (3) JIB extension
- (4) JIB extension cylinder
- (5) JIB support
- (6) JIB support for the ground

**Some accessories can be installed depending on your crane and JIB configuration:**

- (7) JIB hook support [option]
- (8) JIB manual extension [option]
- (9) Raised hook support [option]
- (10) Hook [option]
- (11) Hoist top-roller [option]

**Hooks [option]**

Different hooks can be mounted depending on the crane model.



**DANGER**

Never exceed the maximum permissible loading of the hook.

## Lifting accessories [option]

Equipment placed between the holding device of lifting machinery and the load is considered as a lifting accessory.



## 2.5. Operating system - hydraulic components

The operating system consists of the following hydraulic components:

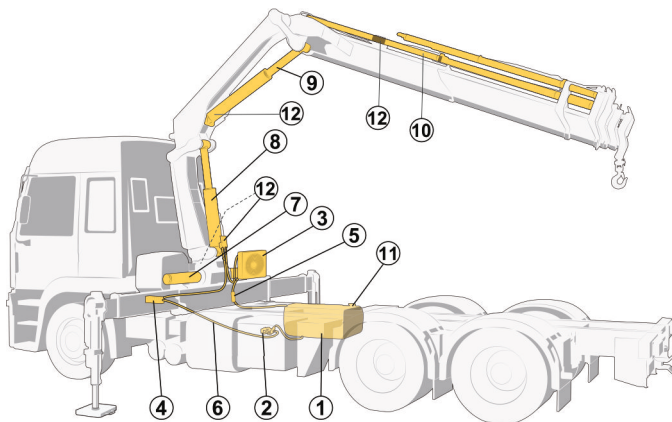

(1) Oil tank	(5) Stabiliser control valve [option]	(11) Return filter
(2) Hydraulic pump	(6) Hydraulic hoses and lines	(12) Load holding valve
(3) Oil cooler [option]	(7) Slewing cylinders / Slewing motors	Pressure filter [option]
(4) Main control valve	Actuators: (8) 1st boom cylinder (9) 2nd boom cylinder (10) Extension cylinder/s	

## 2.6. LHV Load holding valves

All cylinders are equipped with load-holding valves as a safety device. After a crane movement, they hold the crane in position, also in the unlikely event of a burst hose.

If there is a leak or a component fractures, such as a pipe, hose or coupling, the load-holding valves will stop the booms from collapsing down, even when the hydraulic system is switched off, and you operate a particular crane lever.

To operate a hydraulic cylinder equipped with a load holding valve, an opening pressure is required.

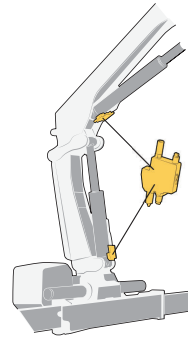

### **DANGER**

It is not permitted to manipulate these devices because you can cause serious accidents.

Only an authorised service workshop can do the servicing, replacement and/or repair of these valves.

## 2.7. Description of the loader crane

The EFFER iQ.950-1200 HP are hydraulic powered loader cranes.

Loader cranes placed in the European Union and the associated EEA (European Economic Area) with the CE marking are manufactured to comply with the provisions of the Machinery Directive 2006/42/EC, the harmonised standard EN 12999, and the directive on Electromagnetic Compatibility (EMC) Directive 2014/30/EU.

Loader cranes imported into the United Kingdom with the UKCA marking are manufactured to comply with the provisions of the Supply of Machinery (Safety) Regulations 2008, the harmonised standard BS EN 12999, and the Electromagnetic Compatibility Regulations 2016.

Loader cranes without the CE or UKCA marking have been designed and calculated according to the standard EN13001.

Stress history class S0 according to EN 12999 (BS EN 12999).

Lifting capacity:

- EFFER iQ.950 HP = 83.5 tonne metres
- EFFER iQ.1200 HP = 91.7 tonne metres

The loader crane is supplied in many versions from:

- EFFER iQ.950 HP E-8 (reach 19.7 metres) to EFFER iQ.950 HP E-10 (reach 24 metres)
- EFFER iQ.1200 HP E-8 (reach 19.7 metres) to EFFER iQ.1200 HP E-10 (reach 24 metres)

The control valve V200, the controller (CombiDrive) and the SPACEevo control system are standard equipment on these loader cranes.

The crane type and the manufacturer are marked on the serial number plate.



### NOTE

The exact technical information for your crane is shown in the Technical Data.

## 2.8. Available configurations

### EFFER iQ.950-1200 HP

Manual extensions	available in combinations:
1 manual extension in JIB	950 E-8/9 + JIB.155Q-6 +1 1200 E-8/9 + JIB.155Q-6 +1

Raised hook support	available in combinations:
Raised hook support in JIB	950 E-8/9 + JIB.155Q-6 1200 E-8/9 + JIB.155Q-6

<b>Hoists</b>	<b>available in combinations:</b>
<b>TI2L</b>	950 E-8/9/10 + TI2L 1200 E-8/9/10 + TI2L 950 E-8 + JIB.155Q-6 + TI2L 1200 E-8 + JIB.155Q-6 + TI2L 950 E-9 + JIB.155Q-6 JDC + TI2L 1200 E-9 + JIB.155Q-6 JDC + TI2L
<b>TI4</b>	950 E-8/9/10 + TI4 1200 E-8/9/10 + TI4 950 E-8 + JIB.155Q-6 + TI4 1200 E-8 + JIB.155Q-6 + TI4 950 E-9 + JIB.155Q-6 JDC + TI4 1200 E-9 + JIB.155Q-6 JDC + TI4
<b>Snatch block</b> for TI2L and TI4	Available in all combinations Not compatible with TI4 in versions 950 E-10 and 1200 E-10
<b>JIBS</b>	<b>available in combinations:</b>
155Q	950 E-8/9 + JIB.155Q-6 1200 E-8/9 + JIB.155Q-6

## 3. Safety precautions and warnings

### 3.1. Operating conditions

You may use the crane **ONLY** if:

- You are outdoors or in a space with sufficient ventilation.
- With a mean wind velocity of less than 13.3 m/sec (approx. 29.7 mph). **Refer to the wind speed table.**



#### DANGER

- **Do not use** the crane in a confined space because you could suffocate from the exhaust gases from the vehicle.
- **Never** use the crane in a high wind or storm. When the mean wind velocity exceeds 13.3 m/sec (approx. 29.7 mph) the crane will behave unpredictably. **Never** use the crane during a thunderstorm.
- **Never** use the crane at temperatures below  $-30^{\circ}\text{C}$  ( $-22^{\circ}\text{F}$ ), as the steel's properties deteriorate below this temperature.



#### WARNING

- At temperatures below  $0^{\circ}\text{C}$  ( $32^{\circ}\text{F}$ ), do not touch the operating levers during the first few minutes.
- In cold weather, the wear on the hydraulic system is greater than at normal working temperatures.

In cold weather, start the crane as follows:

- Engage the power take-off at low rpm.
- Allow the system to idle for a few minutes.
- Operate stabiliser legs up and down for one minute, in order to warm up the oil.



## 3.2. Wind speed

Refer to the table below to correctly identify the wind speed.

### Wind speed averaged over 10 minutes at a height of 10 m

Wind Force	Above flat ground		Characteristics
	m/s	Wind type	
0	0.0 - 0.2	Calm	Calm, smoke rises vertically or nearly vertically
1	0.3 - 1.5	Slight breeze	Wind direction recognisable from smoke plumes, the wind begins to be noticeable on the face; leaves begin to rustle and weather vanes can start to move.
2	1.6 - 3.3		
3	3.4 - 5.4	Moderate wind	Leaves and twigs in continuous movement, small branches begin to move. Dust and paper begin to move over the ground.
4	5.5 - 7.9		
5	8.0 - 10.7	Fairly strong wind	Small leaved branches make swaying movements; crested waves form on lakes and canals.
6	10.8 - 13.8	Strong wind	Large branches move; you can hear the wind whistling in telephone wires; umbrellas can only be held with difficulty.
7	13.9 - 17.1	Severe wind	Entire trees move; the wind causes difficulty when you walk into it.
8	17.2 - 20.7	Stormy wind	Twigs break off, walking is difficult.
9	20.8 - 24.4	Storm	Causes superficial damage to buildings (chimney pots, roof-tiles, and TV antennae are blown off).
10	24.5 - 28.4	Severe storm	Uprooted trees; considerable damage to buildings etc. (occurs infrequently on land).
11	28.5 - 32.6	Very severe storm	Causes extensive damage (occurs very infrequently on land).
12	> 32.6	Hurricane	



#### NOTE

Conversion to different measurements units:

- 1 m/s = 3.6 km/h
- 1 m/s = 2.24 mph



### 3.3. Definition of this loader crane

#### Usage of the crane

The EFFER loader crane is used to lift and move loads in the working area permitted by the load plate and the load diagram. The cranes are normally mounted on a vehicle but they can also be mounted on a fixed base plate. The crane can be equipped with a number of lifting accessories/interchangeable equipment.

#### Permitted/forbidden use of the loader crane

##### Permitted duties:

- Loading and unloading cargo from/on vehicles
- Lifting and moving loads from vehicles
- Handling loads with lifting accessories/interchangeable equipment\* intended to be used on loader cranes.

\*As specified in the documents for the equipment.

##### Forbidden duties (unless the loader crane is specially prepared for a certain duty following authorisation from Hiab):

- Installing the crane on ships or floating structures
- Continuously using the crane as a production crane in assembly lines, foundries...
- Handling loads, working with submerged boom systems or accessories, in strong currents such as rivers
- Applying pressure downwards
- Pushing/pulling with the boom system against any type of obstacle (wall, ground...)
- Transferring loads of unknown weight to the crane
- Using the JIB upside down (please always refer to the Operator's Manual for your JIB to see what is allowed)
- Putting loads on structures if you do not know their resistance
- Lifting a mass that is partially loaded or attached to another equipment/structure/element

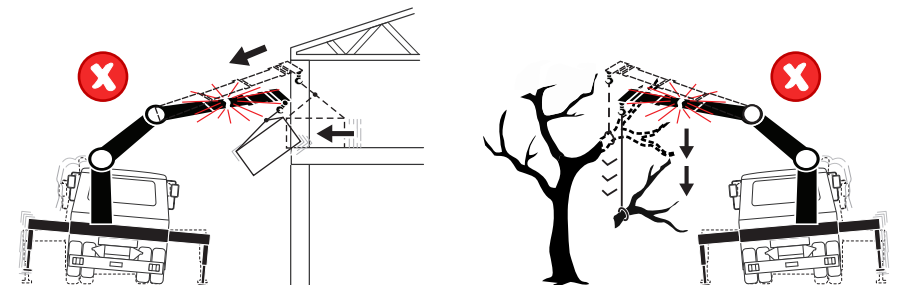

#### CAUTION

There is a risk of tipping the truck and/or damaging the crane, the load or other structures inside the working area.

- Lifting people

- Using a personnel basket (as the crane must be certified as a MEWP crane by a notified body). Please always refer to the MEWP's Operator's Manual.

**DANGER**

Lifting people with a crane is never allowed unless it is a MEWP crane. When working in a personnel basket, both feet must have contact with the floor of the basket. Standing on boxes or ladders in the basket can lead to injury or death.

**3.3.1. Noise declaration**

The following values for emitted noise may be taken as general and conservative values for ordinary installations of loader cranes on normal diesel engine powered trucks. Declared dual-number noise emission values in accordance with ISO 4871:

- Emitted A-weighted sound power level for basic loader cranes in accordance with ISO 3744:  
LwA = 103 dB (Uncertainty: KwA = 2 dB).
- Emitted A-weighted sound power level for loader cranes with hoist in accordance with ISO 3744:  
LwA = 107 dB (Uncertainty: KwA = 2 dB).
- A-weighted sound pressure level at loader crane control stations in accordance with ISO 11201:  
LpA = 95 dB (Uncertainty: KpA = 4 dB).

### 3.3.2. Signs on the crane

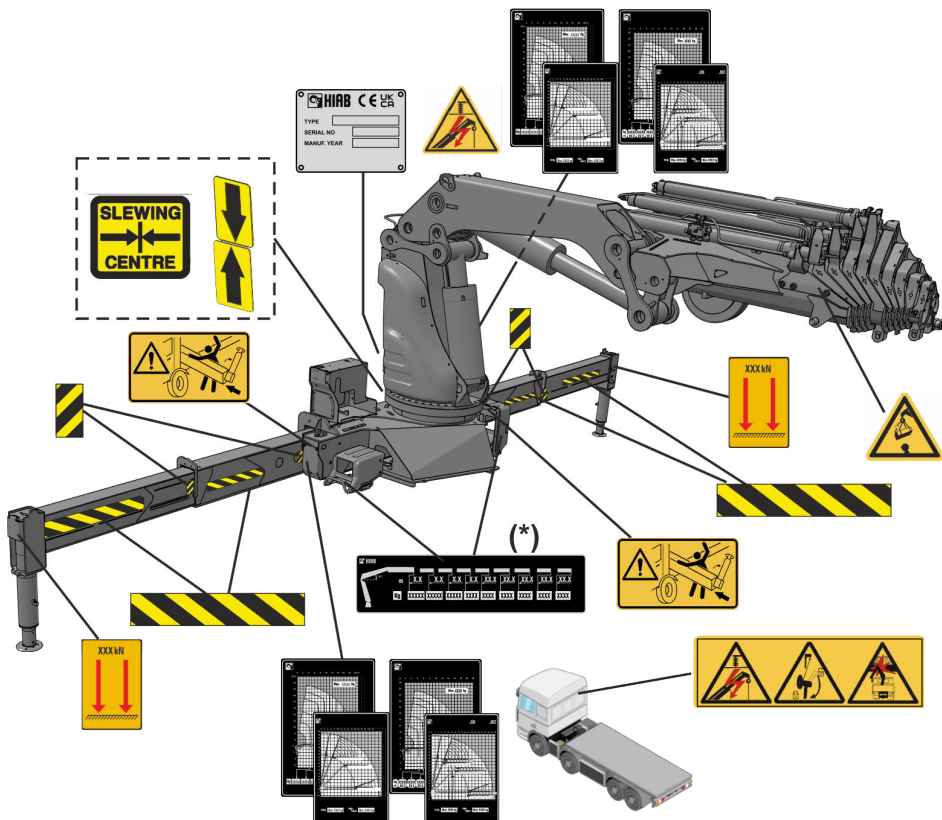

#### NOTE

(\*) This sign is included on the load diagram for some crane models.

### 3.3.3. Maximum load

#### Lifting capacity

Your crane has a certain lifting capacity, expressed in kNm or tm. This lifting capacity is also known as the load moment. The lifting capacity is: the payload at hook multiplied by the outreach in metres that the crane can operate at different positions. The lifting capacity of your crane determines the maximum load your crane may lift within its working zone. However take careful note; the greater the operating radius of the crane, the lower the lifting capacity will be because of the weight of the boom system itself. The load plate and the load diagram on your crane show the maximum loads you may lift in the operating reach of your crane.



**DANGER**

- Overloading could result in damage to the crane or in the worst case, personal injury or death
- Never increase a hanging load, since that may cause a load holding valve to open and/or the vehicle to turn over.
- Never use the crane with the OLP system switched off.



**NOTE**

When you use equipment such as hoist, JIB, lifting accessories or interchangeable equipment and their necessary components, you add weight to the load. Because of this, the load you can lift is less heavy.

**Load plate**

On the plate is the maximum weight that you may lift at a given reach, with the 1st boom in the optimum position. In chapter Technical Data in this manual you will find these values for your crane.

Some crane models don't include the load plate (1), because they have this information included directly in the load diagram (2).

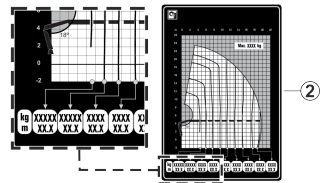
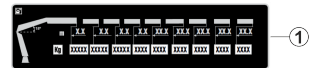

**Optimum position**

The weight that your crane can lift will be determined by:

- Stability test of your crane on vehicle.
- Stabiliser extensions positioned and legs pressed to ground.
- The reach at which you are working and the optimum position of the boom.
- The optimal position for your crane is on the load plate.



**DANGER**

**Never** exceed the maximum weight on the load plate.



## NOTE

To lift with the boom system heavier loads than the ones specified on the boom extension sign, move the hook to the previous hydraulic extension equipped with hook attachment.

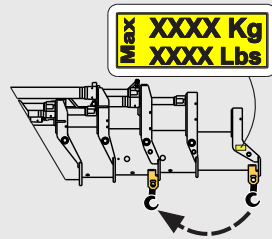

## Load diagram

The load diagrams are placed on the column and show the maximum loads your crane / JIB (if fitted) / hoist (if fitted) may lift in the entire working zone (manual extensions excluded). The load diagram drawing will also be found in the enclosed Technical Data.

**The white area is the working zone of the crane.**

The load curves show the maximum load that may be lifted at a given reach and height. For a given maximum load, the possible working zone is to the left of the load curve. The lifting capacity for some cranes is limited in the high lifting area.

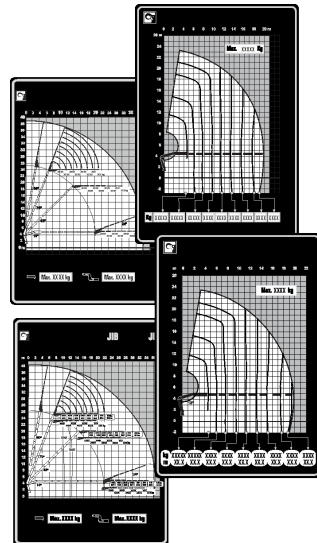

## WARNING

Care must be taken when handling loads in the high lifting area, so the load/tool does not come into contact with the boom system.





## WARNING

Never operate the hydraulic extensions against a solid object when the 1st boom is completely lifted. Do not try to push or compress loads when the 1st boom is fully lifted, as this could cause damage to the 1st boom cylinder.

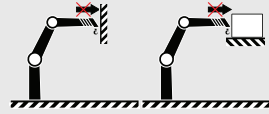

### 3.3.4. Maximum load moment

If your crane has reached the maximum load moment (lifting capacity), the OLP gives a warning and locks any crane movement that will increase the load moment. This is known as an OLP situation.

If the 2nd boom is raised, the following movements are locked:

- 1st boom down/up
- 2nd boom down
- extension boom out

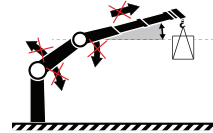

If the 2nd boom is down, the following movements are locked:

- 1st boom up
- 2nd boom up
- extension boom out
- 1st boom down (certain crane types and cases)

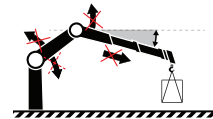

### Lifting the load

Make sure that you always have a clear view of the load. If you do not see the load, you can cause injury to people or serious damage to the surroundings.

### Sling length

Always attach the load using the shortest possible sling.

The angle between the legs of the sling must not be more than 120°.

The maximum working load (or Working Load Limit - WLL) of a multi-legged sling for general purposes is calculated by multiplying the WLL of a single leg by a mode factor (refer to the table).

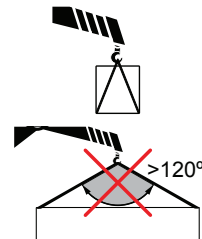

Max angle to the vertical of any sling leg (degrees)	Mode factor two-legged sling	Mode factor three- and four-legged sling
0-45	1.4	2.1
45-60	1.0	1.5

If the angle between the legs of the sling is more than 90°, do not hang the slings directly on the hook. Use a ring hanging from the hook to attach the sling.

### Working close to the load

Put the vehicle as close as possible to the load.

Always try to lift the load with the extension boom retracted, but not completely. In this condition, the crane has the greatest lifting capacity.

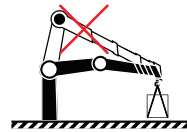

### Working below ground level

If you have to load or unload below the level of the ground, keep the 1st boom angle to about 10 to 30° above the horizontal plane.



### Heavy loads

Lift heavy loads with the 2nd boom in the optimum position in relation to the 1st boom. For this, see the load plate on your crane.

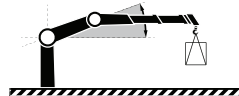

### DANGER

Never exceed the maximum permissible loading of the hook.

### Heavy loads cannot be handled with the boom straight.

Operate the 2nd boom to get an angle in relation to the 1st boom.

### Loads at the extreme limit of the working area

When you lift the load with the 1st boom, make sure that you have at least a small angle with the 2nd boom.



**TIP**

Operate the crane with various functions simultaneously to make smooth crane movements. In this way, you will also prevent the hydraulic system from heating up quickly.

### 3.4. Signals when using a crane

**DANGER**

- If it is not possible to see the load and the entire working area clearly, the crane operator must follow the instructions and signals given by a qualified person.
- The country-specific regulations for crane operator signals are to be used.

Signals in this manual give a number of standard signals that can be used.

**Lift**

Raised arm and index finger raised. Circular motion with the hand.

**Lower**

Arm pointing downwards and index finger down. Circular motion with the hand.

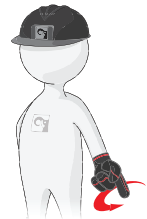



**Stop all crane movements / Hold the load in position**

Raise the open hand, with the palm clearly visible, and arm at shoulder height.

Keep the hand still.

**Emergency stop for all movements by the crane**

Raise the hands and the arms to an oblique angle.

**Very short movement**

Place the hands a very short distance apart, with the palms facing each other. The hands may be held either horizontally or vertically. The next movement may be: Lift, lower, move the lifting gear, change the reach, or turn.

**Change the reach**

Signal with your hands.

- Sideways movement outwards with both hands. Thumbs outwards.
- Sideways movement inwards with both hands. Thumbs inwards.

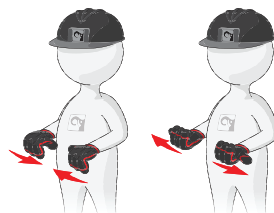

**Turn in the direction indicated**

Indicate the direction with the hands.

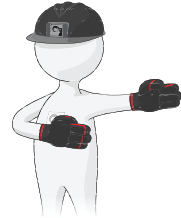
**Open the tool**

Extend the arms at shoulder height, with the palms facing downwards.

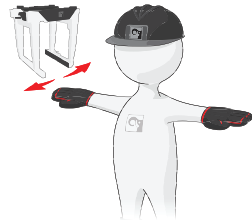
**Close the tool**

Move both hands close together.

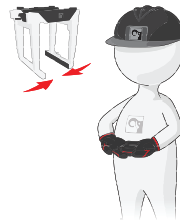
**Lift the open tool a little**

Extend both arms at shoulder height, with the palms facing upwards. Make vertical movements with both arms outstretched.

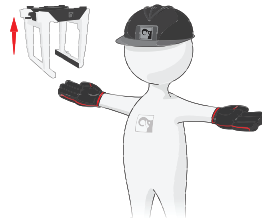

### Keep the tool in position briefly

Raise the hand drooping slightly, with the fist clenched.



## 3.5. Use of the crane

### Starting crane operation



#### DANGER

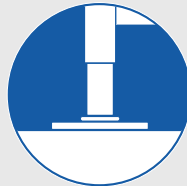

- Make sure that you comply with the regulations of the country in which you use the crane (for example, certificate, safety helmet, and other personal protection devices).
- Check that the ground is sufficiently flat and firm.
- Verify that the ground is not uneven. Be careful with sewers, cellars, excavations etc.
- To make sure that the vehicle stays in its position, always engage the parking brake and place chocks under the wheels.
- Lower the stabiliser legs only on to a flat and firm surface.
- Do not lower the stabiliser legs on the edge of an embankment, soft shoulder, slope etc.
- Make sure that you can see the stabiliser legs and stabiliser extensions when you are operating them.
- The stabiliser legs must not sink in! Use support plates that are large and firm enough for your crane. The plates must not bend because of the load weight.
- Verify that the support plates do not sink as you gradually lift the load.



## DANGER

- Do not stand in front of the hydraulically operated stabiliser legs when you are operating them!
- Never use the stabiliser legs as a parking brake, since the vehicle could start to slide.
- Slide the stabiliser extension, on both sides of the vehicle, completely out if possible. Then lower the stabiliser legs for support.
- Never operate the stabiliser legs/ extensions if there is a load suspended from the crane.



## WARNING

- Use low force when you put the stabiliser legs on the ground.
- Do not raise the vehicle with the stabiliser legs! If you do, you can cause damage to the stabiliser legs.
- Check that the interchangeable equipment and lifting accessories are in good condition!

Interchangeable equipment is usually attached to the boom tip (e.g. hoist, hook, grapple, rotator, etc)

Lifting accessories are connected to the standard load hook (e.g. slings, chains, shackles etc).



## DANGER

Do not stand in front of the boom system when operating the crane out of transport position.

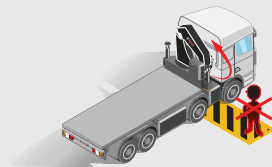

### 3.5.1. Preparations for use



#### DANGER

Make sure that there are no unauthorised persons within the operating range of your crane!

To mark the working area correctly, think about the space that the crane will need to lift the load (direction of the lift, size of the load).

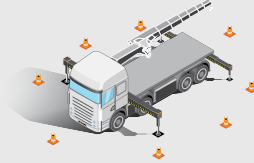

#### CAUTION

- Put on your vehicle's warning lights.
- Make sure that the parked truck does not block emergency exits, pedestrian roads or no-parking zones unless you have permission.
- Make sure that both the truck and the crane do not block the visibility of important signs for other users of the area (for example, road signs).



#### DANGER

- If a part of the crane comes in contact with an electricity line, you will be electrocuted!
- Always keep the following minimum distances between the crane and overhead electricity lines, unless otherwise prescribed by national rules.

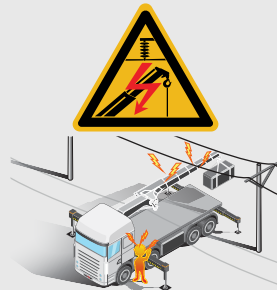

<b>Minimum distance between crane and overhead electricity lines</b>		
Voltage (V)	Minimum distance to an insulated conductor	Minimum distance to an uninsulated conductor
<500 V	0.5 m	2 m
500-40000 V	1.5 m	4 m
>40000 V	2.0 m	6 m
<b>Voltages are found:</b>		
up to 500 V:		to buildings
500-40000 V:		trams, trains
over 40000 V:		power transmission



### **DANGER**

When you go into the control station (high-seat, cabin, platform) remove all jewellery, loose clothing, or other hanging items from your body (for example, rings, scarfs, bracelets...). Jewellery, loose clothes, and other hanging items can be caught in some parts of the crane.



### **DANGER**

When you go into or out from the control station, use only handles and supports on the crane that were specifically made to help the operator to go into or out from the control station.



### **WARNING**

Make sure that you know the position of all the emergency stop buttons on your crane and on the controller.

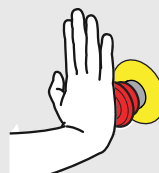

## **3.5.2. Crane operation**



### **DANGER**

Your crane has a control system.

The control system will help you to work safely. Nevertheless, you remain responsible for safe use of the crane!

Therefore, always work according to the operating instructions!

**In an emergency situation, push immediately any of the emergency stop buttons. This will stop all crane movements and prevent the free movement of the load.**



## DANGER

- Keep checking that there are no unauthorised persons within the operating reach of the crane!
- Make certain that you can always see the load!

If your view of the load is not adequate, have someone else give you signals.

See the list of signals. Make certain that you and the person assisting you know these signals.

- Pay attention to the safety of the person giving the signals!
- Never move the vehicle, if you have a freely-suspended load on the crane!
- Never walk or stand under a suspended load!

During operation, never stand below the boom system or load!

- Do not slew the crane, nor lift the 1st boom, nor lift the 2nd boom into their ends positions at full speed. This can damage the crane.





## WARNING

- Never push a load along the ground, or the vehicle's load space, with the extension boom. This can cause damage to the boom system. This will lead to expensive repairs.
- Never use the extension boom as a jack. This could damage the slewing bearings and the connection between the crane column and the crane base.
- Always lift the load from the ground before you start to slew. Do not tow the load over the ground. This can damage the boom system.
- If you are working with loads in restricted spaces (for example, windows):  
Check that the boom system can move up and down freely.  
The boom system will bend somewhat, when loading and unloading the crane.
- If the boom system is in a high position (1st boom above 70°), do not allow the boom to lower at full speed. The crane could go into an uncontrolled movement.  
Be careful if, in particular, the OLP gives an early warning!
- When loading the vehicle:  
Take the load off the stabiliser legs by withdrawing them slightly. The stabiliser legs must remain in light contact with the ground.

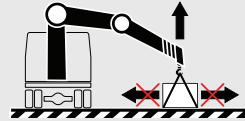

## CAUTION

- Operate the crane using smooth and gentle lever movements.
- If a cylinder is at its end position, free the operating lever. Otherwise overheating can occur.



### 3.5.3. Driving with the crane



#### DANGER

- Never move/drive the vehicle if there is a load suspended from the crane.
- Before you move the vehicle:
  - Check that there is no pump flow to the main control valve. The PTO or power supply must be disengaged. The operating system must be switched off!
- Pay attention to the width and height of the crane in the transport position. The crane must stay within the width of the truck.
- Make sure the stowed crane and its equipment cannot fall, hit bridges, tunnels, other vehicles etc.
- Pay attention to overhead power lines! Make sure that no part of the crane ever comes in contact with overhead power lines.

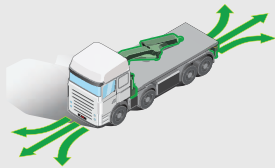
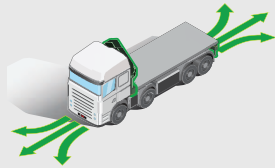

#### NOTE

- For further instructions, refer to the vehicle's manual(s).
- Make sure that you always obey local traffic rules when driving with a crane.

### 3.5.4. Use of lifting accessories and interchangeable equipment



#### DANGER

- Only use interchangeable equipment intended to be used on loader cranes as specified in the documents for the equipment.
- When using lifting accessories, follow the instructions supplied with the equipment!
- Watch out for hazards!
- Never try to adjust lifting accessories when you are working on the crane!

After lifting accessories and/or interchangeable equipment have been fitted:

1. Check that they are securely fixed.
2. Only after this, should you use your crane.

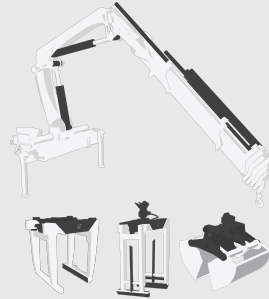

#### NOTE

When you use equipment such as hoist, JIB, lifting accessories or interchangeable equipment and their necessary components, you add weight to the load. Because of this, the load you can lift is less heavy.



#### WARNING

Always insert the locking pin in the shaft for all the attachments on the tip of the crane (hook, top-roller, pulleys...).

Do it in the same direction as shown in the picture.

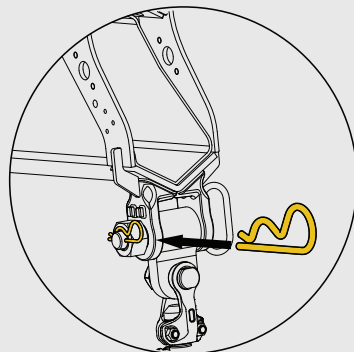

**WARNING**

If you attach/detach equipment to/from the tip of the crane and the boom system is not in horizontal position, stay away to avoid getting caught between the boom extensions as it is normal that they can move towards each other.

Be careful that your fingers do not get trapped.

**WARNING**

Dirt can damage the hydraulic system:

- Clean the couplings, when connecting and disconnecting interchangeable equipment with hydraulic connections.
- Always use the plastic cover protections on the hydraulic connections when disconnecting them.

### 3.5.5. Use of demountable cranes

**DANGER**

- Make sure that there are no unauthorised persons in the immediate vicinity of the crane. When mounting/demounting the crane on/from the vehicle, people can suffer fatal crushing injuries!
- After setting up, verify that the crane is properly locked!

**WARNING**

Be careful when mounting/demounting the crane on/from the vehicle as rough handling can seriously damage the crane or the vehicle.

### 3.5.6. Ending crane operation

**DANGER**

Always end crane operation as follows:

- After use, always place the crane in the transport position!
- Withdraw the stabiliser legs and stabiliser extensions.
- Check that the locking mechanisms are properly locked.
- Switch off the operating system.
- Disengage the PTO or power supply after work.
- If you drive with the PTO or power supply engaged, this will cause serious damage to the PTO/gearbox combination.
- Only after doing the above, you can drive the vehicle away.

## 4. The control system

### 4.1. Control System SPACEevo

SPACEevo is a crane control system.

#### The control system:

- Monitors the crane's operation and prevents unsafe actions.
- Increases the precision with which you can work.
- Makes operation easier.
- Makes troubleshooting easier.

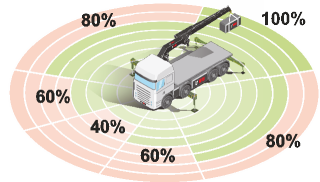

Crane version	Control valve	Control System	Controller
HP	V200	SPACEevo	CombiDrive



#### NOTE

The control system provides a large number of functions. Certain features are standard, others are options.

If you do not use the system for 30 minutes, it will switch itself off in order to prevent draining the truck battery. This feature can be cancelled.

Contact an authorised service workshop.

### 4.2. How the safety system works

On the crane there are various sensors and indicators which send signals about the crane's load, position and movements to a central microprocessor. The microprocessor then decides how the crane can be operated and stops/reduces prohibited movements/speeds according to the following:

- When prohibited movements/speeds are approached, a warning is given.
- When prohibited movements/speeds are reached:
  - On remote controlled cranes prohibited movements are stopped.
  - On manually operated cranes, all movements are stopped, because when a spool is moved too much, power to the dump valve is cut, all movements are stopped.

#### Fault monitoring

When there is a fault in the control system it will give an immediate warning.

Depending upon the fault the crane speed and/or the load capacity will be reduced. When the fault is serious, use of the crane is blocked completely.

**DANGER**

Never try to repair the control system yourself. Repairs may only be made by an authorised service workshop!

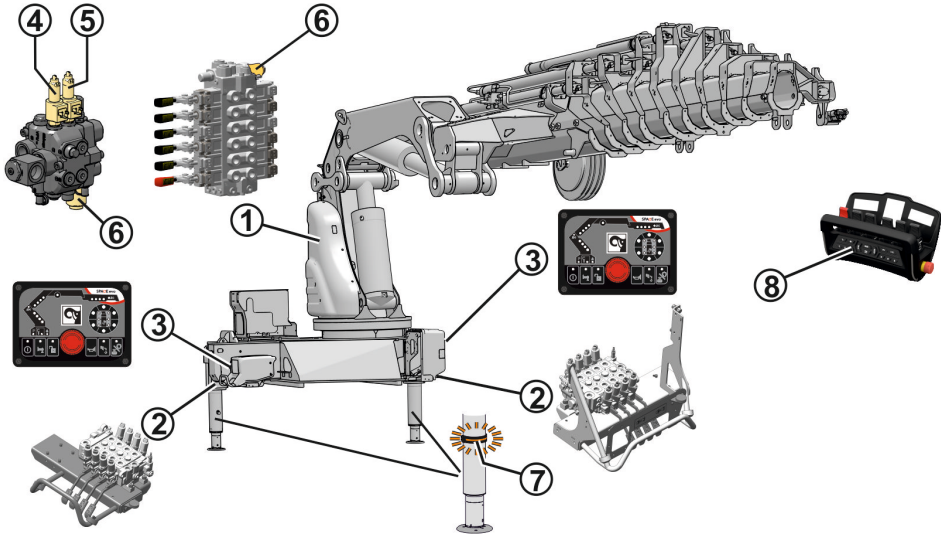
**4.3. Components of the control system**

(1) Main control valve	(4) Dump valve 1	(7) Warning LED lamp
(2) Stabiliser control valve	(5) Dump valve 2	(8) CombiDrive controller
(3) User Interface SPACEevo-UI	(6) Pressure-reducer filter	

**4.4. Standard symbols and functions of the crane and the stabiliser system**

These symbols can be shown:

- On the plates.
- On the control valve levers.
- On the controller (If delivered).



**NOTE**

If you use a controller to operate your crane, you can read about the symbols displayed on it in the dedicated section of this operator's manual.

By default, the symbol on the controller corresponds to the positive movement of the levers. To operate the opposite movement of that symbol, move the lever on the opposite direction.

Always operate the lever according to the function on the symbol sign.

**Basic crane symbols and functions**

SYMBOLS	FUNCTIONS
	Slewing
	1st boom

SYMBOLS	FUNCTIONS
	2nd boom
	Hydraulic extensions

**Extra symbols and functions (if delivered)**

SYMBOLS	FUNCTIONS
	JIB cylinder
	JIB extensions

SYMBOLS	FUNCTIONS
	Hoist
	Rotation tool
	Tool 2

**Stabiliser system symbols and functions (if delivered)**

SYMBOLS		FUNCTIONS	SYMBOLS		FUNCTIONS
		Crane stabiliser extension			Crane stabiliser leg
		Auxiliary stabiliser extension			Auxiliary stabiliser leg
SYMBOLS			FUNCTIONS		
			Front auxiliary stabiliser leg		

## 4.5. Main control valve

The crane can be operated from the main control valve, but as soon as you have selected remote control operation, it is impossible to operate the main control valve levers.

The speed of a function corresponds to the extent of the lever movement, regardless of the load and other functions, as long as the oil flow is sufficient. When the oil flow is insufficient, one or more functions might reduce their speed.

When remote control is used, the oil flow is allocated by means of PFD.

### Standard functions and symbols

The order of the functions is customized for each crane. The images show examples of the main control valve functions placed on the column.

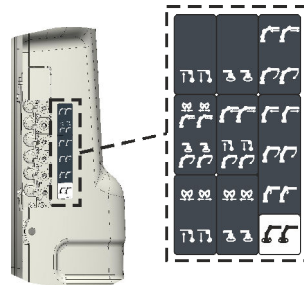
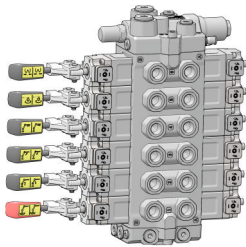
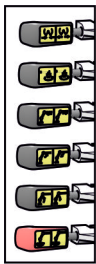

**Main control valve with levers**

**Main control valve without levers**

## 4.6. Different stabiliser control valves

Different stabiliser control valves that you can find on cranes:

- 2-function/4-function control valve included in the main control valve
- 2-function control valve
- 4-function control valve.

You can operate the stabiliser control valve manually or remotely. On remote-controlled cranes the stabiliser control valve levers are only to be used for emergency operation.



## 4.7. User Interface (UI)

### 4.7.1. Buttons on the User Interface

**(1) ON/OFF button**

Activates or deactivates the SPACE system.

**(2) Stabiliser system button**

Enables operation of stabiliser extensions and legs.

**(3) OLP release button**

For OLP release if the crane is in an overload situation and for temporary disconnect the dump valve function.

**(4) Emergency stop button**

Button to push in case of emergency. It stops all crane movements.

**(5) Horn button**

Crane horn activation.

**(6) Manual extension button**

Activates or deactivates the OLP for manual extension mode (if fitted).

**(7) Remote button / Work light button**

Activates or deactivates the controller.



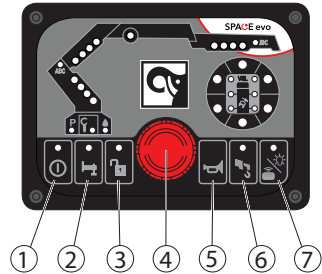



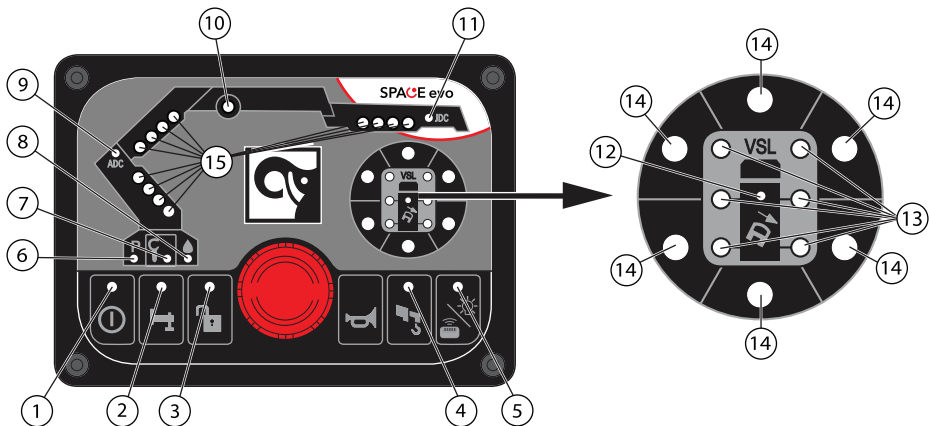

















Activates or deactivates the work light.























### 4.7.2. Indicator LEDs on the User Interface



	<p><b>Power ON/OFF</b></p>	<p>(1)</p>	<ul style="list-style-type: none"> <li> Green LED on: The system is on.</li> <li> Green LED blinking: System on and the emergency stop button has been pushed.</li> </ul>
--	----------------------------	------------	---

	<b>Stabiliser system activation</b>	(2)	<ul style="list-style-type: none"> <li> Green LED on: Stabiliser system active.</li> <li> Green LED flashing: Stabiliser extension operation is blocked</li> </ul>
	<b>OLP Release</b>	(3)	<ul style="list-style-type: none"> <li> Red LED on: OLP</li> <li> Red LED blinking: OLP Release active (crane, VSL or stabiliser leg)</li> <li> Green LED flashing: Critical error.</li> </ul>
	<b>Manual extensions</b>	(4)	<ul style="list-style-type: none"> <li> Green LED on: Manual extension mode is active.</li> <li> Green LED blinking: Hydraulic extensions fully retracted and manual extension mode active.</li> </ul>
	<b>Work light or Remote control</b>	(5)	<p><b>Manually controlled cranes</b></p> <ul style="list-style-type: none"> <li> Green LED on: Work light on.</li> </ul> <p><b>Remote controlled cranes</b></p> <ul style="list-style-type: none"> <li> Green LED on: Remote control is active.</li> <li> Green LED blinking: Button for remote control has been pushed, waiting for connection to hand unit.</li> <li> Red LED on: Radio interference.</li> </ul>
	<b>Parking</b>	(6)	<ul style="list-style-type: none"> <li> Blue LED on: Slew is in parking position / SAF sequence completed.</li> <li> Blue LED blinking: SAF active: folding or unfolding sequence ongoing.</li> </ul>
	<b>Service/Error</b>	(7)	<ul style="list-style-type: none"> <li> Yellow LED on: Service needed.</li> <li> Red LED on: Acknowledged error in the system.</li> <li> Red LED blinking: Critical error.</li> </ul>
	<b>Dump valve</b>	(8)	<ul style="list-style-type: none"> <li> Blue LED on: Dump activated.</li> <li> Blue LED fast blinking: Startup sequence ongoing.</li> </ul>

<b>ADC</b>	<b>ADC</b>	(9)	<ul style="list-style-type: none"> <li> Blue LED on: Indicates that the ADC feature is active and the crane has full capacity.</li> </ul>
	<b>Hoist</b>	(10)	<ul style="list-style-type: none"> <li> Green LED on: Hoist mode.</li> <li> Red LED flashing fast blinking: Rope-end warning (3 turns left on the drum).</li> <li> Red LED blinking: 90% of OLP pressure.</li> <li> Red LED on: 100% of OLP pressure.</li> </ul>
<b>JDC</b>	<b>JDC</b>	(11)	<ul style="list-style-type: none"> <li> Blue LED on: Indicates that the JDC feature is active (crane outermost extension fully retracted and the JIB has increased capacity).</li> </ul>
	<b>VSL</b>	(12)	<ul style="list-style-type: none"> <li> Red LED on: VSL - OLP reached.</li> </ul>
	<b>Stabiliser legs</b>	(13)	<ul style="list-style-type: none"> <li> Green LED on: Stabiliser leg set.</li> <li> Red LED blinking: Stabiliser leg end-of-stroke.</li> <li> Red LED on: Stabiliser leg OLP.</li> <li> Red LED blinks for 5 seconds when SPACE is OFF: Stabiliser leg not in transport position.</li> </ul>
	<b>Stability sector</b>	(14)	<ul style="list-style-type: none"> <li> Green LED on: 90-100% stability.</li> <li> Yellow LED on: 70-89% stability.</li> <li> LED off: 20-69% stability.</li> <li> Red LED on: 0-19% stability.</li> </ul>
	<b>Cylinder pressure</b>	(15)	<ul style="list-style-type: none"> <li> 1 of 4 green LED on: 50% of maximum pressure reached.</li> <li> 2 of 4 green LED on: 70% of maximum pressure reached.</li> <li> 3 of 4 red blinking LED: 90% of maximum pressure reached.</li> <li> 4 of 4 red LED on: 100% of maximum pressure reached.</li> <li> 4 of 4 red running LED: OLP release activated.</li> </ul>

LED test for the User Interface, see Daily inspection.

## 4.8. Dump valves

### Dump valve 1. (1)

Allows operation of the crane functions. To prevent high pressure and thereby unnecessary heating of the oil there is an automatic dumping function. When no lever movement has been made for 3 seconds SPACE system opens the dump valve and the oil is returned directly to the hydraulic tank. As soon as the operator moves a lever the valve closes.

### Dump valve 2. (2)

Allows operation of the stabiliser extensions and legs only when this valve is activated. The dump valve 2 will be placed between the main control valve and the stabiliser control valve. The dump valve 2 must be activated from the SPACE interface before the stabiliser system can be controlled.

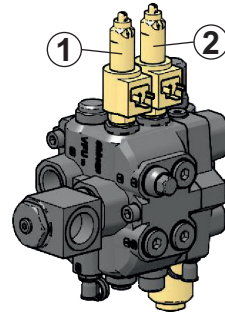

## 4.9. Pressure-reducer filter

Pressure-reducer filter integrated in the main control valve and in the supply valve [option]. The oil goes through the filter and then to the positioner(s).

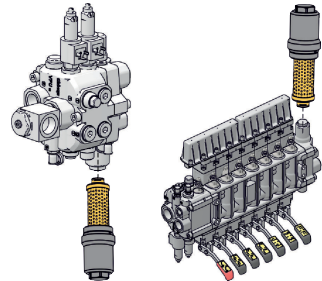

## 4.10. Warning LED lamps

A warning LED lamp on each stabiliser leg is used to warn the surrounding about ongoing activity, by amber light indication. A warning LED lamp also gives information to the operator about the different statuses of the crane.

- System ON: the stabiliser leg lamps light up
- Remote control ON: the stabiliser leg lamps blink
- 90% of maximum permitted load and OLP: the stabiliser leg lamps double blink

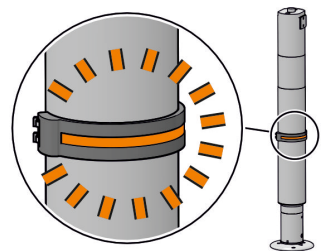

## 4.11. CombiDrive controller

The controller has either six or eight levers. Usually, it operates wirelessly via radio, but you can also use the cable. The displays continuously provide you with information that is possible to customise.

**The communication with the crane occurs with:**

- A radio for two-way communication inside the controller.
- A transceiver fitted at the crane base.

The controller sends and receives information. In the transceiver, there is a corresponding unit which handles the traffic at the other end.



### 4.11.1. Cable connection [option]

A 15-metre cable is supplied as an option with the controller. The cable is for temporary operation. The cable connects to the vehicle through the connector (1) on the crane base.

When the cable (2) is connected to the controller (3), the centre display shows the symbol for cable operation.

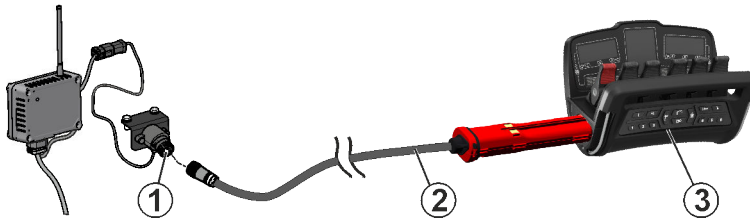

### 4.11.2. Lights and vibration on the controller

On your controller, push the button  to display the SETTINGS VIEW.

Push the button  as many times as necessary to select the sub-VIEW controller lights.

To activate or deactivate the lights, move the lever according to the symbol(s) shown in the side displays.



Use the light on the controller as a warning light to make yourself visible in the dark.

Use the light on the controller as a torch to illuminate an operational area.

The controller has also a vibrating indication that activates for some types of notifications.





### 4.11.3. CD4 displays

#### The centre display

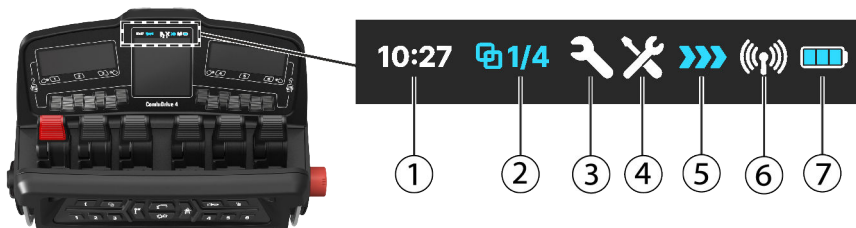
The centre display shows fixed information on the top bar, and variable information that changes with the VIEW that you select.

You can adjust and customise this information depending on your needs.



- **Time (1)**  
It shows the time set on the control system.
- **Alternative display selection (2)**  
With this button  you can change the current available display in a VIEW.
- **Error (3)**  
This symbol appears if the control system has an error. The centre display shows a big spanner symbol and the crane stops. After 3 seconds, if you still see the big spanner, push the release button  to acknowledge the error. The spanner will go to the top bar of the display with a reduced size. Push the button  and select ERROR CODES to know more about the error(s).
- **Service needed (4)**  
It shows that it is time for service. When you start the controller, the centre display shows this big symbol that then moves to the top bar of the display with a reduced size. You can find more information about the service counters if you push the button  and select the OPERATIONAL INFO VIEW.

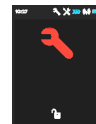

• **Crane speed mode (5)**

It shows the selected crane speed. You can have three different speeds: low, medium (MID), high.

If you change the speed with the configurable button, the centre display shows the big symbol of the speed selected that then moves to the top bar of the display with a reduced size.



LOW SPEED



MEDIUM SPEED



HIGH SPEED

• **Radio reception (6)**

The white antenna symbol shows the radio signal strength. Six waves indicate the best reception.

If the signal between the controller and the transceiver is lost (RADIO LINK LOST), the centre display shows a symbol. It goes out of view when the connection is back.



• **Battery status (7)**

The battery symbol shows the remaining power in the battery. The centre display shows a symbol when there is little capacity left. When the battery is low, the horn of the crane also operates a sound two times.

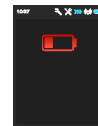

**Side displays**

The left and right displays show:

- The symbol (A) for the function that each lever controls in the active VIEW, and the OLP percentage of some functions. Function symbols change according to the VIEW selected. The function symbols show a direction (for example, up, down, left, right, etc...) that applies when you move the lever forward.
- The text (B) for the features set on the configurable buttons (for example, start/stop engine, increase/decrease rpm on the engine, etc...). The feature of each button can change according to the configuration of the specific crane.

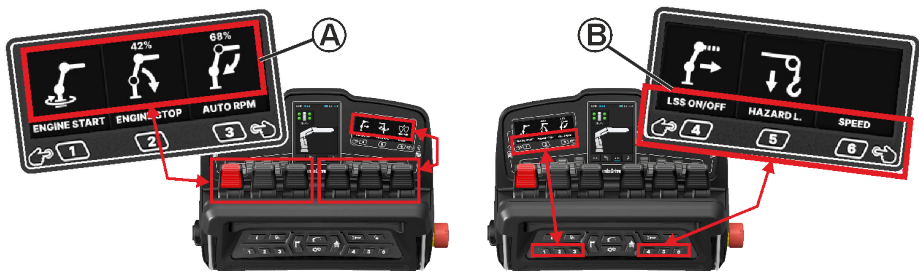

#### 4.11.4. Buttons

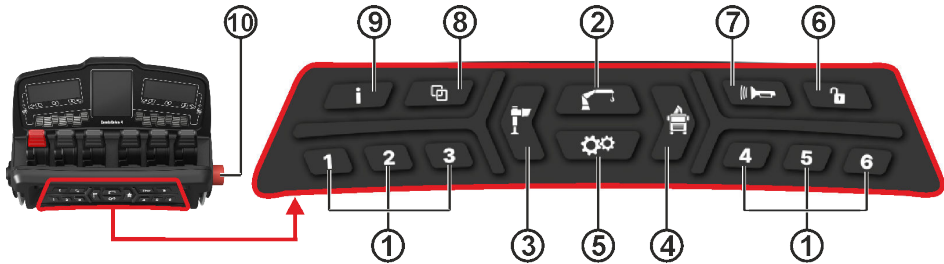

(1)	<p><b>Configurable buttons</b></p> <p>The controller has six configurable push-buttons for controlling features, for example start/stop engine, increase/ decrease rpm on the engine, etc. The feature of each button depends on the configuration of the specific crane.</p>	<p><b>OLP release</b></p> <p>Push and hold to activate OLP release. See section “OLP release”.</p> <p>Push to acknowledge an error.</p>	(6)
(2)	<p><b>CRANE VIEWS</b></p> <p>Push to select different CRANE VIEWS.</p>	<p><b>Horn</b></p> <p>Push to sound the horn.</p>	(7)
(3)	<p><b>STABILISER SYSTEM VIEWS</b></p> <p>Push to select different STABILISER SYSTEM VIEWS.</p>	<p><b>Alternative displays</b></p> <p>Push to select the different available displays on the centre display.</p>	(8)
(4)	<p><b>TRUCK VIEWS</b></p> <p>Push to select different TRUCK SYSTEM VIEWS.</p>	<p><b>INFO VIEWS</b></p> <p>Push to select different INFO VIEWS.</p>	(9)
(5)	<p><b>SETTINGS VIEWS</b></p> <p>Push the button to enter the SETTINGS VIEWS.</p> <p>Push to select different SETTINGS VIEWS.</p>	<p><b>Emergency stop button</b></p> <p>Push to deactivate the controller. Release to activate.</p>	(10)



### Locking the controller

1. Push and hold button (3) and (4) while the emergency stop button (8) is pushed.
2. Keep button (3) and (4) pushed while you pull out the emergency stop button (8). The centre display then shows a large locked padlock symbol

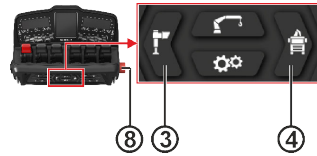

### Unlocking the controller

1. Push and hold button (3) and (4) while the emergency stop button (8) is pushed.
2. Keep button (3) and (4) pushed while pulling out the emergency stop button (8).
3. Release button (3) and (4).

The controller is ready to use.

## 4.11.5. Operational VIEWS, standard functions and symbols

### Operational VIEWS:

- CRANE VIEWS, button (2)
- STABILISER SYSTEM VIEWS, button (3)
- TRUCK VIEWS, button (4)
- SETTINGS VIEWS, button (5)
- INFO VIEWS, button (9)

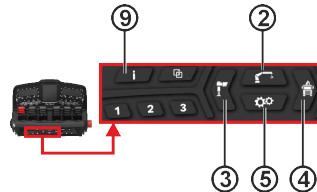

In each of the primary VIEWS, you can select different sub-VIEWS by pushing the same VIEW button repeatedly. The number of sub-VIEWS depends on the configuration of the crane.

Example for the different sub-VIEWS of the CRANE VIEWS:

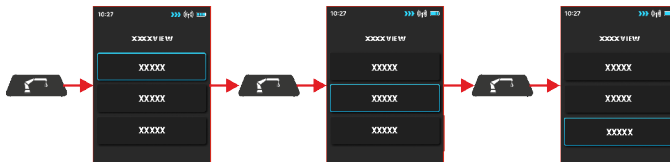

### CRANE VIEWS

Push the button to select different sub-VIEWS of the CRANE VIEW. Then, wait about two seconds and the selected sub-VIEW will be displayed.

## Centre display

The CRANE VIEW has as a general layout:

Screen area	Information	
Primary display (1)	<ul style="list-style-type: none"> <li>Crane status</li> <li>Stabiliser system status</li> <li>Vehicle data</li> </ul>	
Secondary display (2)	<ul style="list-style-type: none"> <li>Crane status</li> <li>Stabiliser system status</li> </ul>	
Warnings display (3)	Crane warnings when they occur	
Features display (4)	Features status: active or not active	

The different information shown in each area depends on the crane configuration and the alternative VIEW selected. Push the button to change between the different alternative displays for the CRANE VIEWS.

## Side displays

These CRANE VIEWS show the symbols for the different crane functions corresponding to each lever, the percentage of the OLP for some functions and the text for the features set on the configurable buttons.

To operate the different crane functions on your crane:

1. Push the button to select different sub-VIEWS of the CRANE VIEW. Then, wait to two seconds and the selected sub-VIEW will be displayed.
2. Select the CRANE VIEW to operate.
3. The side displays on the controller shows the available functions to operate.

The symbols on the controller side displays show the functions of the specific function.



### IMPORTANT

Each function is operated using a specific lever on the controller. If a lever is faulty or moved at startup, the lever and the function are disabled. The other levers work as usual.



### NOTE

With the two extra levers on the eight-lever controller, it is possible to use the seventh and eighth functions at the same time with functions 1-6, without changing to another CRANE VIEW.

The functions presented in each VIEW can be customized depending on crane configuration. It can be changed by an authorised service workshop.

Example of sub-VIEWS for the 6 and 8 levers controller:

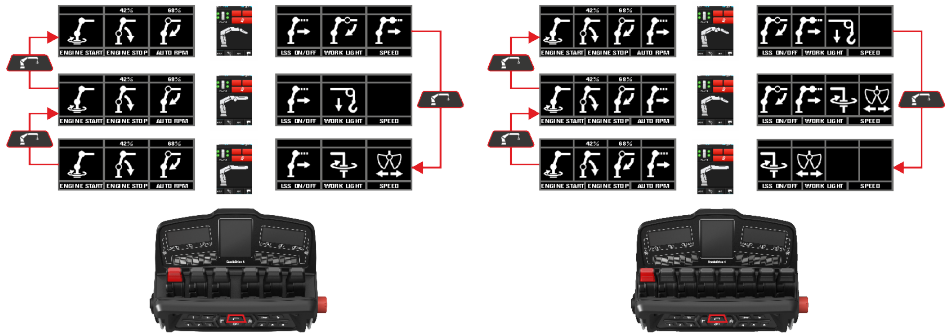

When the operator pulls out the emergency stop button on the controller, it always starts in CRANE 1 VIEW. The sub-VIEWS in CRANE VIEW are configured in production but can be changed by Effer service personnel.

### STABILISER SYSTEM VIEWS

Push the button to navigate through the different sub-VIEWS of the STABILISER SYSTEM VIEW. Once selected, wait to 2 seconds and the sub-VIEW selected will be displayed.

#### Centre display

The STABILISER SYSTEM VIEW shows on the full screen:

- VSL diagram (1)
- Vehicle silhouette (2)
- Stabiliser system:
  - Front auxiliary stabilisers (3)
  - Main crane stabiliser system (4)
  - Auxiliary stabiliser system (5)
  - Rear auxiliary stabiliser system (6)

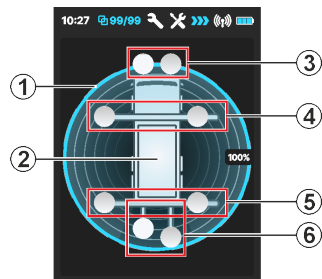

The display also shows the stabiliser legs and extensions status:

- Stabiliser leg not set to the ground (1)
- Stabiliser leg set to the ground (2)
- Stabiliser leg in OLP situation (3)
- Stabiliser leg at the end of the stroke (4)
- Stabiliser extension totally extended (5)
- Stabiliser extension partially extended (6)

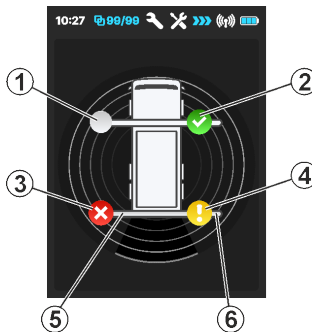

The different information shown in the alternative view depends on the crane configuration. Push the button  to change between the different alternative displays for the STABILISER SYSTEM VIEWS.

### Side displays



These STABILISER SYSTEM VIEWS show the symbols for the different stabiliser extensions and legs functions corresponding to each lever, and the text for the features set on the configurable buttons.

To operate the different stabiliser systems on your crane:

1. Push the button  to navigate through the different sub-VIEWS of the STABILISER SYSTEM VIEW. Once selected, wait to 2 seconds and the sub-VIEW selected will be displayed.
2. Select the STABILISER SYSTEM VIEW to operate.
3. The side displays on the controller show the available functions to operate.

The functions presented in each VIEW can be customized depending on crane configuration. It can be changed by an authorised service workshop.

The symbols on the controller side displays show the functions of the specific stabiliser system:

Stabiliser system	Stabiliser system position	Stabiliser extension function (out/in)	Stabiliser leg function (down/up)
Main crane stabiliser system			

Stabiliser system	Stabiliser system position	Stabiliser extension function (out/in)	Stabiliser leg function (down/up)
Auxiliary stabiliser system			
Front auxiliary stabiliser system			
Rear auxiliary stabiliser system			



### IMPORTANT

Each function is operated using a specific lever on the controller. If a lever is faulty or moved at startup, the lever and the function are disabled. The other levers work as normal.

Example of sub-VIEWS for the 6 and 8 levers controller:

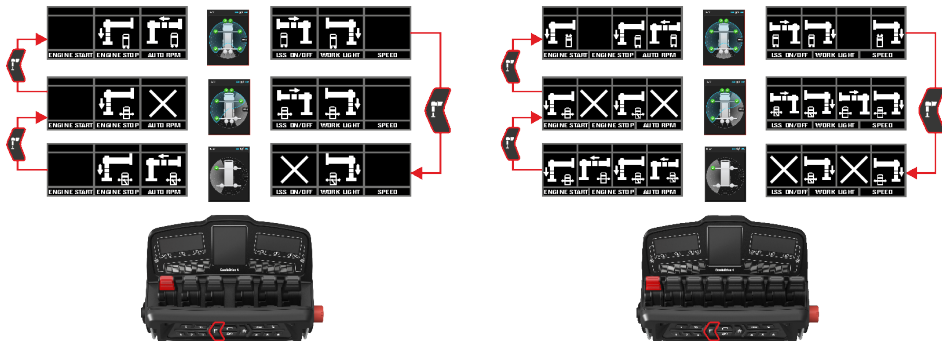

## TRUCK VIEWS

Push the button to navigate through the different sub-VIEWS of the TRUCK VIEW. Once selected, wait to 2 seconds and the sub-VIEW selected will be displayed.

These TRUCK VIEWS include the extra functions that are installed on the vehicle.

### Centre display

The TRUCK VIEW shows on the full screen the description of the VIEW.

The different information shown in the alternative view depends on the crane configuration. Push the button to change between the different alternative displays for the TRUCK VIEWS.

### Side displays

These TRUCK VIEWS show the symbols for the different functions corresponding to each lever and the text for the features set on the configurable buttons..

To operate the different extra functions on your crane:

1. Push the button to navigate through the different sub-VIEWS of the TRUCK SYSTEM VIEW. Once selected, wait to 2 seconds and the sub-VIEW selected will be displayed.
2. Select the TRUCK VIEW to operate.
3. The side displays on the controller shows the available functions to operate.

The symbols on the controller side displays show the functions of the specific function.



### IMPORTANT

Each function is operated using a specific lever on the controller. If a lever is faulty or moved at startup, the lever and the function is disabled. The other levers works as normal.

The functions presented in each VIEW can be customized depending on crane configuration. It can be changed by an authorised service workshop.

Example of sub-VIEWS for the 6 levers controller:



## SETTINGS VIEWS

Push the button  to select different sub-VIEWS of the SETTINGS VIEW. Then, wait about two seconds and the selected sub-VIEW will be displayed.

These SETTINGS VIEWS include the different settings and features that you can activate or deactivate for your crane and controller.

### Centre display

The SETTINGS VIEW shows on the full screen the symbols for the different settings and the status of all of them:

- If they are active, the symbols are highlighted and shows a blue bar at the bottom (1).
- If they are not activated, they are shown in grey (2).

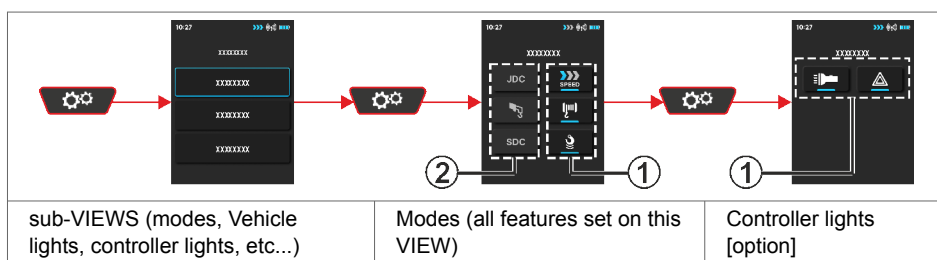

The different information shown in the alternative view depends on the crane configuration. Push the button  to change between the different alternative displays for the SETTINGS VIEWS.

### Side displays

These SETTINGS VIEWS show the symbols for the different settings or features corresponding to each lever and the features set on the configurable buttons.

To activate or deactivate the different settings or features on your crane:

1. Push the button  to select different sub-VIEWS of the SETTINGS VIEW. Then, wait two seconds and the selected sub-VIEW will be displayed.
2. The side displays on the controller shows the available settings or features to activate or deactivate.
3. Move the lever according to the position of the symbol to activate or deactivate the settings or features.

The functions presented in each VIEW can be customized depending on crane configuration. It can be changed by an authorised service workshop.

Example of sub-VIEWS for the 6 levers controller:



## INFO VIEWS

Push the button to select different sub-VIEWS of the INFO VIEWS. Then, wait two seconds and the selected sub-VIEW will be displayed.

These INFO VIEWS include all the information for your crane.

### Centre display

The INFO VIEW includes these sub-VIEWS:

- **Error codes:**
  - **Critical errors (1)**
  - **Warnings (2)**
- **Operational info (3):**
  - **Use time:** number of hours that the dump valve has been active.
  - **Use time to service:** number of hours with the crane engaged until next service.
  - **Total time:** number of hours that the crane has been engaged.
  - **Time to service:** number of hours with the crane engaged until next service.
  - **Lifts to service:** number of lifts until next service.
  - **Lifts:** number of lifts made.

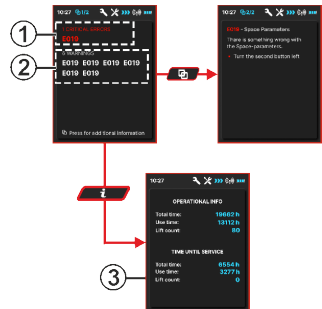

The different information shown in the alternative VIEWS depends on the crane configuration. Push the button to change between the different alternative displays for the INFO VIEWS and get extra information.



## SAF symbols shown on the displays

The order of the levers/buttons is customized. The side displays show the symbols for each lever/button.

- (1) SAF - fold/unfold the boom system.
- (2) SAF - confirm extension in.
- (3) SAF - not confirmed extension in.

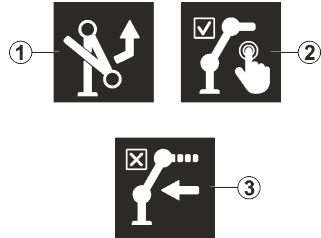

### NOTE

For the SAF feature, the movement of the lever (positive or negative) will be the difference between folding or unfolding the boom system.

## 4.11.6. Battery and battery charger

### Battery

Install a fully-charged battery in the controller as shown on the right. It is important to fit the battery the right way round and lock it by turning the switch on the battery (A).

In order to keep your battery in good condition for a long time, there are a few simple rules to follow:

- Regularly clean the connectors on the batteries (B) and the battery charger (C).
- A new battery needs a bit of running-in before it will reach full capacity. The first 4-5 cycles, charge the battery completely. Then, use the battery until it stops because of low battery power in the controller.

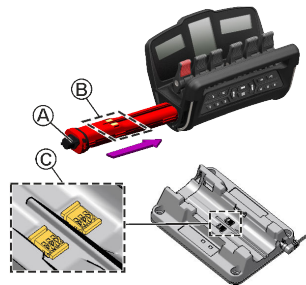

### NOTE

During this time, do not take a halfway charged battery from the charger or a halfway discharged battery from the controller.

- If you are not going to use the battery for a long period, store it fully charged in the temperature range +5°C to +25°C (41°F to 77°F). You must not leave the battery without charging it more than 6 months and after this period, always follow the running-in procedure described above again.
- Never store a discharged battery.

### Battery charger

The battery charger is to be fitted in a protected environment, preferably in the cab. Two batteries are delivered with each unit, one of which can always be placed in the battery charger.

The battery charger works equally well in 12V systems and 24V systems.

Normal charging time for a flat battery, is approximately 1.5 hours. Operating ambient temp: Battery = 0° to +45°C (32°F to 113°F).

### LEDs status

The green LED (D) on: when the charger is active.

The LED (E) indicates the status of the charger and the battery:

- Green LED blinking: during charging the battery.
- Green LED on: when the battery is fully charged.
- Red LED blinking: when the temperature is too high.
- Red LED on: Error. The battery charger is not working.

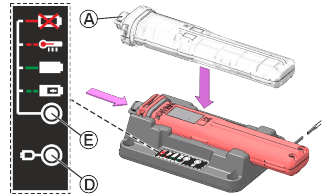

### How to charge the battery:

1. Place the battery in the correct position of the charger. The two connectors on the battery must be in contact with the connectors in the battery charger.
2. Push the battery into the charger until it stops. The LED (E) starts blinking green.
3. Lock the battery position by turning the switch on the battery (A).
4. When the LED (E) is steady green, the battery is fully charged.



### NOTE

A charged battery is a concentrated energy source. Never store a charged battery in a toolbox or similar, where there is a risk of a short due to metal components. Used batteries should be taken care of according to the local regulations.

## 4.12. Other components of the control system SPACEvo

### Main ECU (Electronic Control Unit)

This box contains the processor of the control system.

You can find this box:

- On the crane base for the rack and pinion slewing system cranes.
- On the crane column for the continuous slewing system cranes.



### Slave ECUs (if needed)

These boxes help to the Main ECU for additional inputs and outputs.

If your crane configuration request these ECUs, you could find them:

- On the crane base for the stabiliser system or the auxiliary stabiliser system.
- On the JIB.

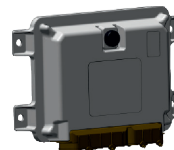

## Harnesses

These are the cables to connect all the devices to the respective boxes.



## VIB (Vehicle Interface Box)

Connection box between the vehicle and the crane.

You can find this box under one of the User Interface boxes.

This box includes some fuses to protect several devices on the crane.

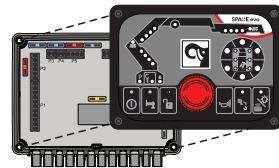

## Relay box

This box contains all the relay connections and a fuse for the electronic system.



## 5. Starting crane operation

### 5.1. Starting operations

- **General case:**

Put the vehicle on a flat, firm and stable surface. The vehicle inclination ( $\alpha$ ) during crane operation must **not be more than 3°**. If this value is exceeded, unintentional crane movements can occur.

To determine the inclination of the truck, check the spirit level on the crane. When the bubble is in the middle of the gauge, the crane is in horizontal position. When the bubble is between the two circles, the crane inclination is between 0° and 5°.

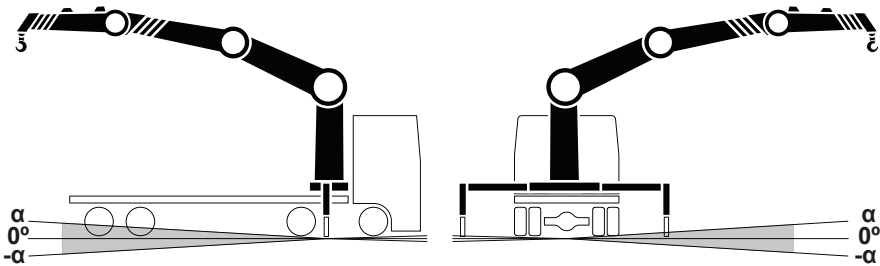
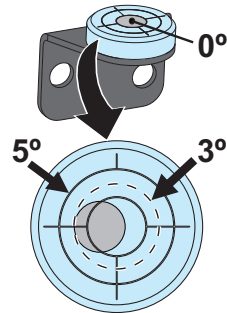

- **Working with boom system beyond 60°**

To avoid side deflection and in order to guarantee the safest operation when working with e.g. lifting accessories, interchangeable equipment and/or Hoist applications and/or MEWP applications, the vehicle has to be completely levelled in any direction ( $\alpha=0^\circ$ ).

- **Particular case 1: Working with extra load on the vehicle platform to benefit from VSL+. [option]**

To avoid sudden movements of the vehicle and damages on the stabiliser system, the vehicle must be completely levelled in any direction ( $\alpha=0^\circ$ ).

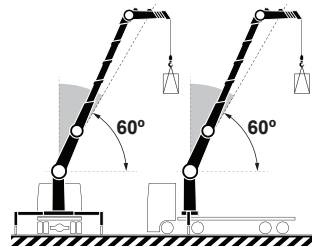

#### NOTE

- Operating the crane in to and out of transport position must also be done with the vehicle completely levelled.
- Activate the parking brake and place chocks under the wheels to prevent vehicle movement.

## Engage the PTO

1. Activate the parking brake and place chocks under the wheels to prevent vehicle movement.
2. Engage the PTO (Power Take Off) and bring the vehicle engine to the correct rpm.



### NOTE

- Rpm too high: the oil in the hydraulic system might overheat.
- Rpm too low: during crane operation, the vehicle engine could stall.
- The maximum rpm may depend upon a governor on your PTO combination.



### CAUTION

Close the driver's cab to prevent access to unauthorised persons.

## Start the control system

The operating levers must be in neutral position before start up. To start the control system, push the ON/OFF button  on the User Interface.

The LED above the button lights up. The system will check itself for a few seconds. The warning lamps on the stabiliser legs light up.

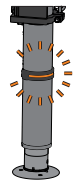
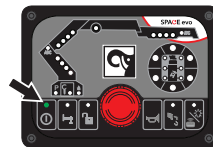

### NOTE

The control system always starts in remote mode for remote-controlled cranes.

## Start the controller

1. Fasten the controller to a waist belt, or shoulder-/neck strap, in the most comfortable operating position. The emergency stop button should be on the right-hand side.  
The operating levers must be in neutral position before start up.
2. To activate the controller, wait 2 seconds after starting the control system and then release the emergency stop button by turning it clockwise. The LED above the remote button becomes steady and the warning lamps on the stabiliser legs blink.

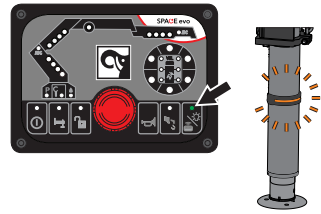

## Indications CombiDrive

**Updating battery (1)** is shown on the centre display while uploading data from the battery if needed.

**Updating software (2)** is shown on the centre display while updating the software if needed.

**Connecting (3)** is shown on the centre display while radio contact is being established.

When contact has been established:

**CRANE VIEW (4)** is displayed on the controller.

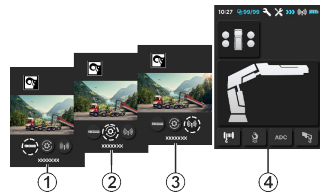

## 5.2. Set the stabiliser system

To ensure the maximum stability of the vehicle, all the stabiliser extensions and legs must be fully extended and set to the ground without lifting the wheels from the ground.

- **Cranes with VSL:** when the stabiliser extensions are not fully extended, the lifting capacity is optimised by the VSL feature to ensure the maximum stability of the vehicle.

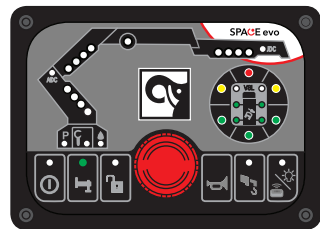

### WARNING

If your vehicle has a front auxiliary stabiliser system, with one or two legs, make sure that all legs are correctly set to the ground before you start operating the crane.

## Confirm view

The operator must have a full view of the stabiliser system when operating it. To confirm a full view of the stabiliser system, button  is pushed on the User Interface on the side where the stabiliser system is going to be operated. As soon as the button has been pushed, the LED for the active stabiliser leg will light green.

You don't have to push that button if your crane configuration has the CD4 confirmation view sensors. This system is automatically detecting which side is the operator with the controller.

---

### **Stability sector indication**

**Cranes with VSL:** the stability sector LEDs will indicate the crane capacity in six different sectors due to stability.

### 5.2.1. Stabiliser system and ground conditions

**Always:**

- Make sure that the ground can support the load that the stabiliser leg imposes on the ground. (\*)
- Make sure that the ground is not undermined.
- Use the extra support plates that are large and firm enough for your crane model.

**The maximum permitted ground inclination under the stabiliser leg plate is 5°.**

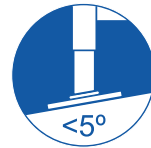
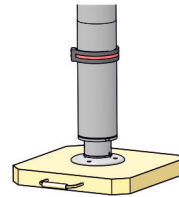

(\*) The maximum load (P) that the stabiliser leg can apply to the ground is (kN):

Crane Model	Stabiliser leg config.			
	Short	Medium	Long	Extra long
EFFER iX.355 HP	230	200	180	-
EFFER iX.550 HP	-	250	250	-
EFFER iQ.950-1200 HP	370	370	370	370
HIAB Auxiliary stabilisers: 2.3 m	140			
HIAB Auxiliary stabilisers: 5 m	180			
HIAB Auxiliary stabilisers: 6 m - 8 m	260			
HIAB Auxiliary stabilisers: 8.7 m	320			



**NOTE**

Sign that shows the maximum force that the stabiliser legs can apply to the ground.





**NOTE**

Sign that shows the maximum force that the auxiliary stabiliser legs can apply to the ground.



**DANGER**

Check that the extra support plates do not bend or sink into the ground.

Do not lower the stabiliser legs on the edge of an embankment, soft ground, hollows, etc... Lower the stabiliser legs only on to a flat, firm and stable surface.

## 5.2.2. Activate the stabiliser system



### Manually-controlled stabiliser system:

1. Make sure that the manual control is active. If not, push the button  on the User Interface.
2. Push the button  to activate the stabiliser system operation.

### Controlled stabiliser system from the high seat:

- Confirm the view on both sides of the crane on the User Interface installed on the high seat [option].

### Remote controlled stabiliser system without the CD4 sensors for confirmed view:

1. Make sure that the remote control is active. If not, push the button  on the User Interface.
2. Select the menu for the stabiliser system on the controller.
3. On the side where the stabiliser extensions are to be operated outwards, push the button  on the User Interface to activate the stabiliser system operation and confirm the view. The stabiliser legs can be driven up and down regardless of the side.

### Remote controlled stabiliser system with the CD4 sensors for confirmed view:

The sensors for confirmed view detect automatically which side you are with the controller and allow you to operate directly the stabiliser extensions on that side without pushing any confirmation button.

The stabiliser legs can be driven up and down regardless of the side.

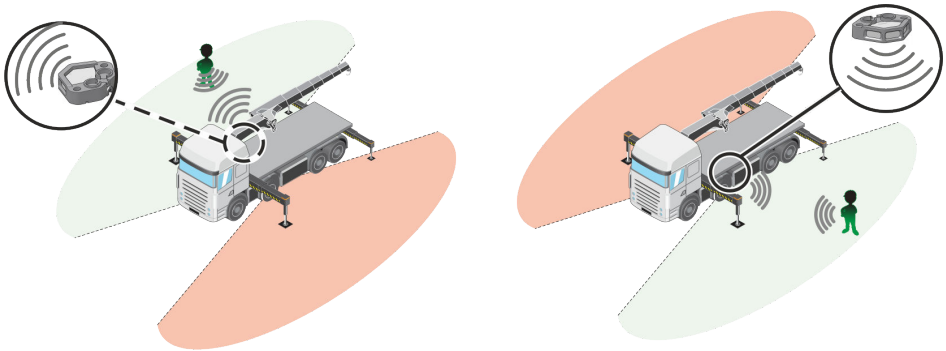

### WARNING

Despite the system detecting the side where you are with the controller, you must make sure that you have a full view of the stabiliser system during the operation to prevent accidents or injuries.

- Select the stabiliser system view on the controller. The CD4 shows on the display the grey area (1) where you are located with the controller and the permitted movements. The CD4 only permits the stabiliser extension movement on the side you are located with the controller (2) and not the opposite side (3).



### NOTE

When the sensor detects the controller, the controller vibrates and you have approximately 10 s to start the stabiliser extension movement. If you do not start the movement during this period, the connection between the controller and the sensor is disabled and the controller vibrates again.

To enable the connection again and restart the 10 s operation:

1. Cover the back part of the controller with your hand or move away from the sensor detection sector.
2. Wait until the grey area (1) is not shown on the controller.
3. Remove your hand from the back part of the controller or enter again in the sensor detection sector.
4. Then, the sensor will detect the controller and the 10-second operation is possible again.
5. The stabiliser system button on the UI blinks with a green light when the stabiliser operation is permitted.

### 5.2.3. Extend the stabiliser extensions

The procedure of setting the stabiliser extensions can differ depending on the type of stabiliser extensions. Repeat the instructions for the stabiliser extension on the other side of the vehicle. For auxiliary stabiliser system [option]: Repeat the process.

### Hydraulically controlled stabiliser extensions

Unlock the stabiliser locking device (1) (if fitted) and extend the stabiliser extensions with the levers on the valve or the controller depending on your crane configuration.

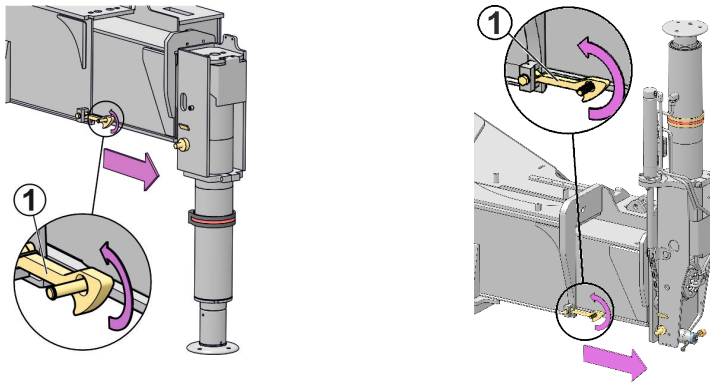

#### DANGER

Do not stand in front of the hydraulically operated stabiliser extensions when you are operating them!

### 5.2.4. Set the stabiliser legs

The procedure of setting the stabiliser system differs depending on the type of stabiliser system. Repeat the instructions for the stabiliser extension and leg on the other side of the vehicle. For auxiliary stabiliser system [option]: Repeat the process.



#### WARNING

Take care not to lower the stabiliser leg onto your foot.



#### NOTE

For cranes with VSL the stabiliser leg downward movement is automatically stopped at a pre-given force level. To exceed this pre-given force level, operate the stabiliser leg down once again.

**DANGER**

Always ensure that the stabiliser legs and stabiliser extensions are in working position and securely locked.

Never operate up any stabiliser leg if you have load on the crane.

**NOTE**

At the end of the operation, do a check of the levelling of the vehicle with the spirit level. If necessary, adjust the stabiliser system.

**Put the extra support plates**

- Put the extra support plates under the stabiliser leg plates (if necessary).

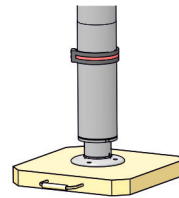
**DANGER**

Do a check that the support plates do not bend or sink into the ground!

**Non-tiltable stabiliser legs**

1. Make sure that the stabiliser extensions are extended.
2. Put the extra support plate (1) onto the ground (if necessary).
3. Operate the stabiliser leg downwards until it is set to the ground.

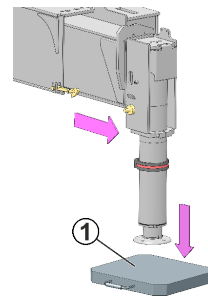

## Hydraulically controlled tiltable stabiliser legs



### DANGER

Do not stand in the tilting area. Make sure the tilting mechanism remains unlocked during the complete tilting.

1. Make sure the stabiliser extension is extended a little and the stabiliser leg can be rotated freely of the vehicle.
2. Tilt the stabiliser leg:  
Pull out the locking pin (1) and turn the lever (2) 180°. Operate the stabiliser leg lever until the stabiliser leg (3) has turned 180°.
3. Turn the lever (2) -180° and check that the locking pin (1) is automatically locked. Make sure that the stabiliser leg is properly locked.
4. Extend the stabiliser extension.
5. Put the extra support plate (4) onto the ground (if necessary).
6. Set the stabiliser leg to the ground.

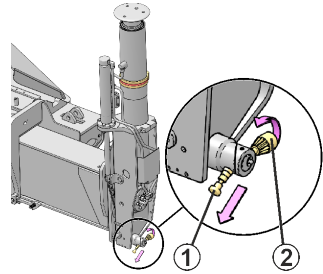

### WARNING

Always check that the stabiliser legs and the stabiliser extensions are in correct position and tilting mechanism is locked in working position.

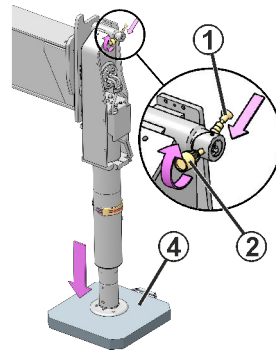
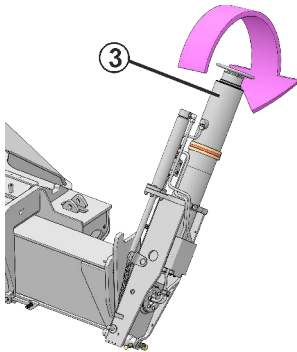

### 5.3. Operate the boom system out of transport position



#### WARNING

- A crane with interchangeable equipment and/or optional components can differ from the operations described in this section. For this reason, study the operating instructions for any interchangeable equipment and/or optional components carefully.
- Always ensure that the stabiliser extensions and legs are in working position and securely locked before operating the boom system out of parking position.
- You must disable the SDC (Synchronize Distance Control) feature when you fold or unfold the boom system. Use the hoist function to wind or unwind the rope during these operations.



#### DANGER

Always operate a manually controlled crane from the position shown in the image!



1. If the stabiliser system is manually controlled, push button  on the User Interface to activate remote control.

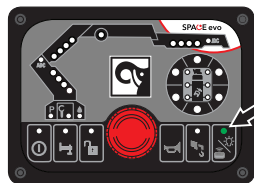

2. If using remote control, the crane will start in remote mode automatically. Push button (1) on the controller to change between the different crane menus or CRANE VIEWS.



#### NOTE

As soon as you have selected remote control operation, it is no longer possible to operate the levers of the main control valve.

### 5.3.1. SAF Semi Automatic Folding [option]

SAF is a feature which allows the operator to fold or unfold the boom system in one single sequence using only one lever.



#### Unfold the boom system semi automatically



#### WARNING

Never use SAF with mounted tools.



#### WARNING

Make sure there is enough space for the boom system to unfold/fold semi automatically. If the situation does not allow SAF, use crane mode to operate the boom system out of/into the parked position.

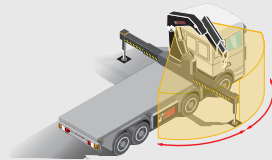

#### WARNING

If your crane has manual extensions, make sure that they are totally retracted or removed before operating the crane with the SAF feature.



#### WARNING

If your crane has long JIB support, make sure that it is totally retracted before operating the crane with the SAF feature.





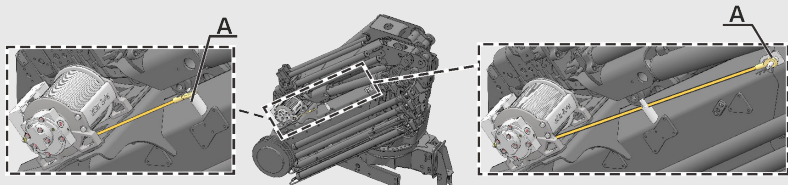

#### WARNING

If your crane has a hoist, change from hoist to hook operation.

Make sure that the rope is on the 2nd boom support and it does not pass through any pulley. If not, remove the rope from the pulleys and put it in the 2nd boom support (A) before operating the crane with the SAF feature.





1. Select the menu for SAF on the controller.
2. If SAF is not configured in a separate crane menu, push the button  to activate it.
3. Operate the lever on the controller until the boom system has been fully unfolded:
  - XSDrive  or 
  - CombiDrive 



### DANGER

Pay careful attention when using this feature.

Always maintain eye contact when operating the crane.

During this movement, the boom system will unfold itself, release the lever immediately if the boom system is about to:

- Hit a person
- Hit an object
- Hit a moving obstacle that suddenly comes closer to the crane.

4. If SAF is not configured in a separate crane menu, push button  to deactivate it.

### 5.3.2. BDA Boom Deployment Assistance [option]

BDA is a feature in SPACE that prevents the operator to move the 2nd boom and extensions in the wrong direction when operating the crane in to or out of transport position.

#### • Operating the crane to transport position:

When the angle  $\beta$  is  $>135^\circ$  between the horizontal and 2nd boom, the system does not allow to raise the 2nd boom or to move extensions out/in.

Press the button for release to allow 2nd boom and extensions movements.

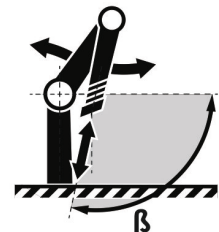
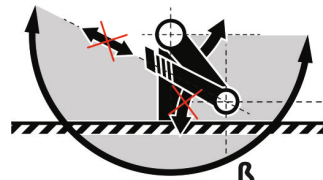

### DANGER

Only use the BDA override to get the crane out of a locked position.

#### • Operating the crane out of transport position:

When the angle  $\beta$  is  $<135^\circ$  between the horizontal and 2nd boom, 2nd boom and extensions can move without any restrictions.

### 5.3.3. Operate the boom system

#### EFFER iQ.950-1200 HP



#### NOTE

SAF option is possible with this crane configuration.

When the stabiliser extensions are extended, the catcher "A" will be released and allow the movements of the 1st boom.

1. Operate the 2nd boom (1) against the 1st boom.
2. Retract carefully the extensions (2).
3. Raise the 1st boom (3) until BDA allows you to operate the 2nd boom or  $\beta > 135^\circ$ .
4. Raise the 2nd boom and boom system (4).



#### CAUTION

- Pay careful attention not to damage the slewing motors.
- Pay careful attention not to damage the catcher "B".

5. Extend the hydraulic extensions (5) .
6. Slew the crane (6) to the working position. The crane is now ready for use.

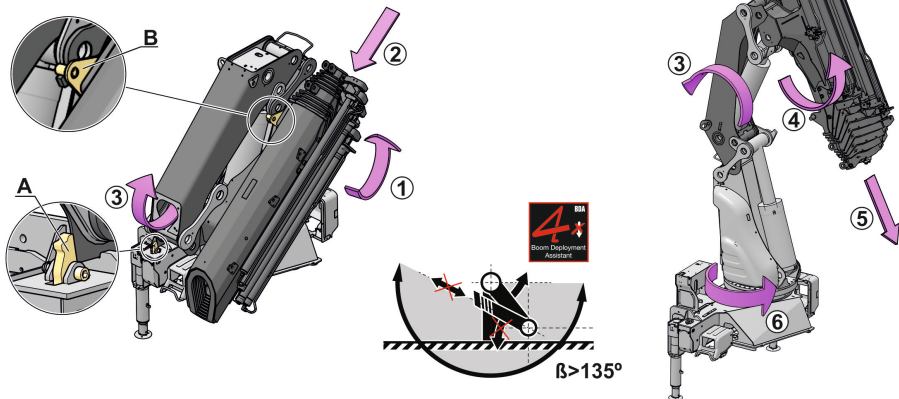

#### NOTE

As soon as you have selected remote control operation, it is impossible to operate the main control valve levers.

## 6. During operation

### 6.1. Features

The control system provides a large number of features. Certain features are standard, others are options.

#### 6.1.1. Controlling the crane speed with the controller CombiDrive

At startup the crane speed is set to 100%. It is possible to choose between three different speeds via a configurable button or a lever.

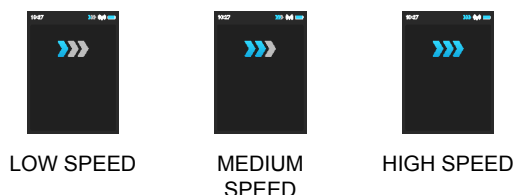

#### Controlling the crane speed with the configurable buttons

Push the appropriate button to change the crane speed. The centre display will show the big symbol of the selected crane speed. The symbol then moves to the top bar of the display with a reduced size.



#### Controlling the crane speed with the levers

1. Press the button on the controller for the SETTINGS VIEW.
2. Navigate to MODES sub-VIEW.
3. Change the crane speed with the appropriate lever. The centre display will show the symbol of the selected crane speed.

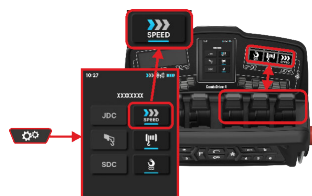

### 6.1.2. Supervision of spools

If a valve spool movement is greater than the equivalent lever or joystick movement on the controller, a safety feature is tripped, and all crane movements stops.

This occurs if a control lever on the valve is moved while the remote control is engaged.

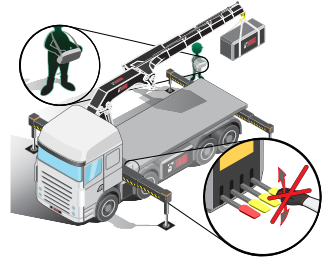

### 6.1.3. APO Automatic power off

APO is a feature which automatically switches off the power to the control system. It consists of:

1. Timeout controlled power off. (30 minutes by default).
2. Parking brake controlled power off.

Through the vehicle's parking brake, APO offers a feature which ensures that the control system is off when the vehicle is moving. When parking brake is released, the control system receives a signal and shuts OFF.

#### For emergency operation

During 5 seconds, it is possible to activate the control system by pushing the ON/OFF button on the User Interface.

### 6.1.4. ADO Automatic Dumping of Oil

If a lever is not moved for 3 seconds, this feature diverts the oil to the tank, thereby preventing the oil from overheating. The next lever movement stops the dumping and it functions as normal.

### 6.1.5. ASC Automatic Speed Control

The ASC feature automatically provides the extra power by reducing the speed smoothly, when working close to the rated capacity. When the load decreases, normal speed is restored.

### 6.1.6. ADC Automatic Duty Control

The purpose of the ADC feature is to optimise the use of the steel structure.

The first boom pressure sensors indicate if there is a positive or negative pressure on the first boom.



#### Adjusted capacity

- If the crane is pressed down, the sensors indicate a negative pressure and the lifting capacity is adjusted during the complete lifting cycle.  
When the lifting cycle ends, the capacity will return to full capacity.

#### Full capacity (ADC mode)

- ADC lamps light up or the symbol is active.  
If the sensors indicate a positive pressure, the lifting capacity is normal during the complete lifting cycle.

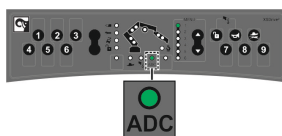
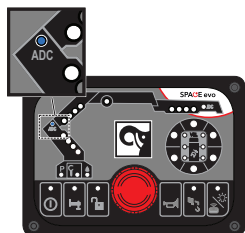

### 6.1.7. PFD Pump flow distribution

When operating several functions simultaneously the pump flow may not be sufficient. PFD will now take over, reducing the speed of all operated functions. Uncontrolled movements are thus avoided, smooth simultaneous operation is achieved.

### 6.1.8. VSL Variable Stability Logic

The VSL feature detects the position of the stabiliser extensions and that the stabiliser legs are pressed to the ground. This optimises the crane lifting capacity in relation to the vehicle's stability.

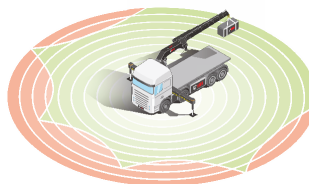

### The VSL diagram

After the installation on the truck, the installer prints unique stability diagrams for each crane. In the diagrams, each colored curve shows the cranes stable area and the maximum working pressure in the 1st boom cylinder with stabiliser extensions in different outreach. The more you extend your stabiliser extensions the more stability and crane's capacity you will get.

The diagram shows 9 different sectors surrounding the crane and in each sector there is a percentage shown. A percentage of 90 indicates that the available working pressure is reduced to 90% in this sector.

Examples of stability diagrams:

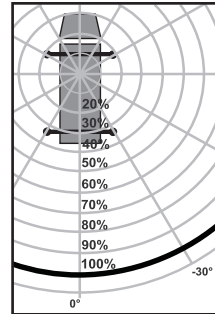

### Stability diagram (One ON/OFF sensor on stabiliser extensions)

With one On-Off sensor, you see two curves and two positions of the stabiliser extensions:



Not fully extended 0-99% (shown as 0%)



Fully extended (100%)

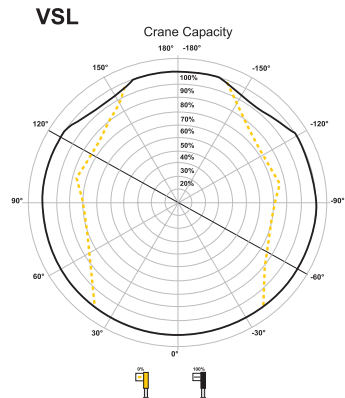

### Stability diagram (Two ON/OFF sensor on stabiliser extensions)

With two On-Off sensors, you see three curves and three positions of the stabiliser extensions

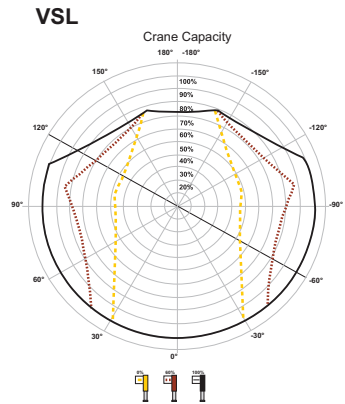
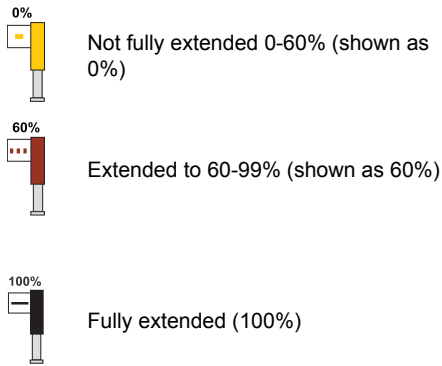

### Stability diagram (Variable analogue sensor(s) on stabiliser extensions)

With variable sensors any position can be read. You see six curves and six positions of the stabiliser extensions.

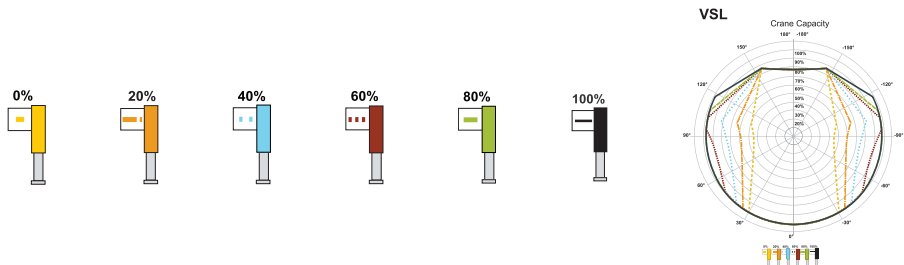

#### NOTE

For cranes with JIB, you will have an additional diagram.

### VSL diagram with the controller CombiDrive

The VSL diagram is updated according to the real situation of the stabiliser extensions and legs status. These are different examples of the VSL diagram.

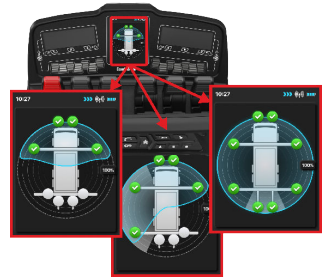

### The Load Chart:

The software creates six different capacity diagrams with the stabiliser extensions in different positions (represented in the truck drawing). For cranes with JIB, another six capacity diagrams will be automatically generated.

The software calculates three loads:

- **CURVE (A):** Maximum load at maximum outreach (1).
- **CURVE (B):** Automatically generated by the software.
- **CURVE (C):** Automatically generated by the software.

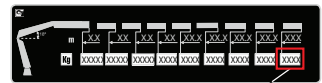
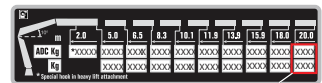



The three coloured curves represent the three different loads. These loads are represented by the position of the crane in each sector (degrees) and also by the outreach of the boom extensions (meters or feet and inches).

The different positions of the stabiliser extensions are shown in the text over the picture diagram (D).

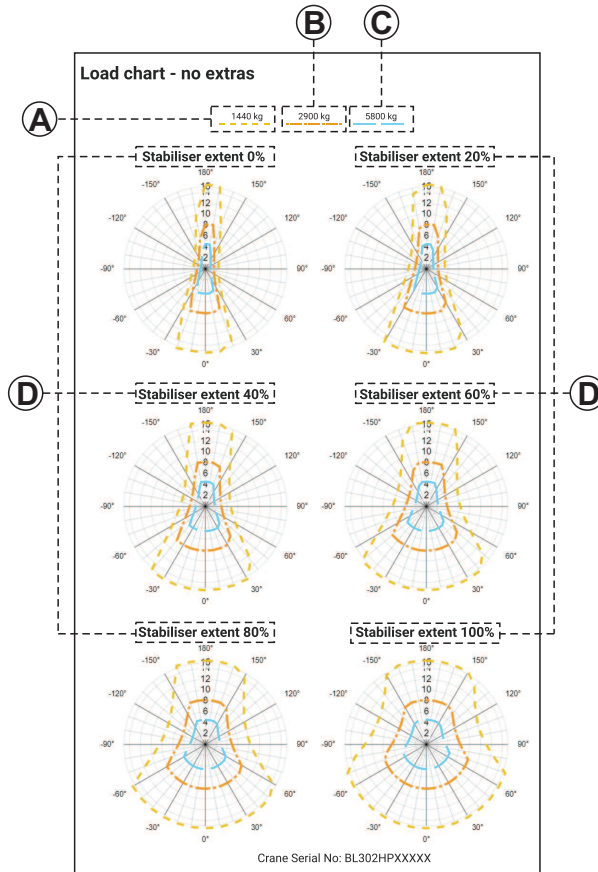

**NOTE**

Speak to your authorised service workshop to request these diagrams for other loads.

### 6.1.9. VSL+ (Variable Stability Logic Plus) [option]

VSL+ is a patented feature that automatically optimises the crane's capacity in relation to the vehicles stability.

VSL+ works like VSL but has the capability to take advantage if the vehicle platform is loaded, the extra load acts as a counter weight.

This automatic feature increases flexibility, especially on worksites where it is not possible to utilize the full stabiliser extension reach.



#### WARNING

In order to get the maximum benefit from the VSL+ system, some of the wheels of the vehicle shall be lifted from the ground but Hiab strongly recommends that at least one wheel is braked by the parking brake and has contact with the ground.

The percentage on the main display shows the capacity gained due to the feature VSL+.



### 6.1.10. LSS-V Load stabilising system-vertical [Option]

LSS-V reduces vertical oscillations in the boom system. This feature makes it easier to handle loads at long outreach.



#### WARNING

Disable LSS-V when working in confined spaces. Compensating movement can cause the crane to collide with obstacles.

If LSS-V is enabled when SPACE is switched off, it will be active when SPACE is started again.

#### Enable and disable LSS-V with the CombiDrive controller

##### Enable and disable with the configurable buttons

1. Push the applicable button to enable or disable the feature.  
By default: push button (7) to activate and deactivate the feature.
2. Make sure that the symbol of the feature is ON or OFF in the main centre display.



##### Enable and disable with the levers

1. Press the button  on the controller.
2. Navigate to MODES sub-VIEW.
3. Enable or disable the feature with the applicable lever.
4. Make sure that the symbol of the feature is ON or OFF in the main centre display.

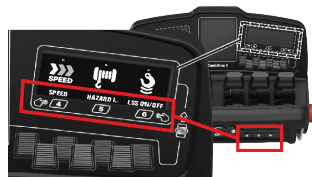

## 6.2. OLP Overload protection

OLP is a safety feature that prevents overloading of the crane. From 90% to 100% of maximum permitted pressure, the warning LED lamps on the stabiliser legs double blink.

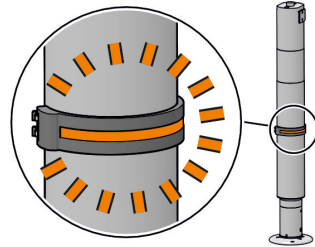

### 6.2.1. User Interface: Boom system OLP

When 100% of the maximum permitted pressure is reached, OLP cuts in and stops all functions that increase the pressure.

The pressure level in the 1st and 2nd boom is indicated by the LEDs on the User Interface:

- 50% of maximum pressure – 1 of 4 LEDs light green
- 70% of maximum pressure – 2 of 4 LEDs light green
- 90% of maximum pressure – 3 of 4 LEDs blinking red
- 100% of maximum pressure – 4 of 4 LEDs light red

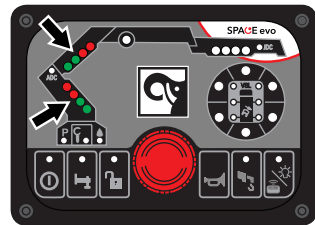

#### NOTE

Do not operate heavy loads with the extensions fully retracted. In an OLP situation, it is an advantage to be able to retract the extensions.

### 6.2.2. User Interface: Stabiliser system OLP

If a stabiliser leg is overloaded, slewing is stopped in the direction towards the stabiliser leg where the OLP occurs. The crane stops. The warning lamps on the stabiliser legs will blink. On the User Interface, the LED for the overloaded stabiliser leg will light red. Move the levers to neutral and only operate permitted (pressure-reducing) functions.

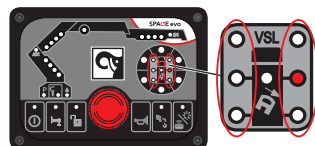

### 6.2.3. User Interface: VSL-OLP

VSL-OLP occurs when there is a risk of instability of the vehicle. Slewing is stopped towards the instability direction and the crane stops. On the user interface the LED for VSL-OLP and the LEDs for the 1st boom will light red. Move the levers to neutral and only operate permitted (pressure-reducing) functions.

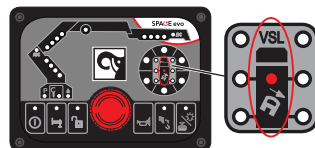

### 6.2.4. OLP with manual control

If one prohibited function is used, all functions will stop. The crane will be fully operational as long as only allowed functions are used.

## 6.3. OLP - indications on the controller

### Boom system OLP on the CombiDrive controller

A percentage of the maximum permitted pressure in the cylinders is shown on the side displays.

**0-89%** of the maximum permitted pressure. No indication on the centre display.

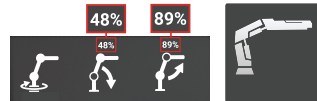

**90-99%** of the maximum permitted pressure. The boom and its cylinder that reaches 90% become yellow on the centre display.

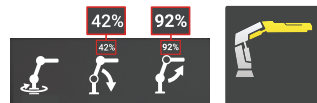

**100%** of the maximum permitted pressure. The boom and its cylinder that reaches 100% become red on the centre display. All functions that can increase pressure are blocked. Operate only permitted (pressure-reducing) functions.



### Stabiliser system OLP on the CombiDrive controller

If a stabiliser leg is overloaded, slewing is stopped in the direction towards the stabiliser leg where the OLP occurs. The crane stops. The centre display shows the symbol 100% and the symbol for the stabiliser leg that has overload (marked red with an X). Move the levers to neutral and operate only permitted (pressure-reducing) functions.

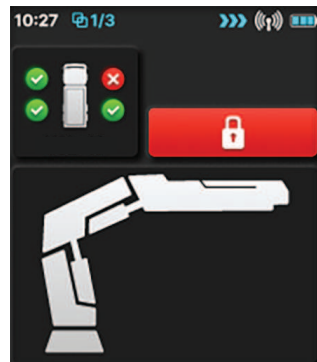

## VSL-OLP on the CombiDrive controller

The centre display shows the symbol VSL. The 100% symbol in the left display alternates with OLP for the crane. Move the levers to neutral and operate only permitted (pressure-reducing) functions.



## 6.4. To release OLP

If all functions have been blocked due to OLP, it is possible to temporarily release OLP and operate an appropriate crane function to correct the overload situation. OLP release is active in 5-second intervals. After each 5-second interval of OLP release, there is a waiting time before the release operation can be activated again. The waiting time will increase in three steps: 30, 60 and maximum 90 seconds. During each 5-second interval, only one function at a time can be operated. Extension out cannot be operated at all. The 5-second interval starts to count as you move the lever.



### DANGER

Only use the OLP release to get the crane out of a locked position. Never use the OLP release to overload the crane deliberately!



### NOTE

In case of a crane breakdown, the use of OLP release will be part of the investigation. If the use of OLP release is too excessive, it might affect warranty.

## OLP release on User Interface

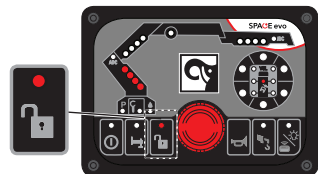

Push and hold the button  while you operate load-reducing functions.

The LEDs of the cylinder in OLP show a running light, and the LED for the padlock symbol blinks red.



## OLP release on controller CombiDrive

Push and hold the button  on the controller while you operate load-reducing functions. The unlocked padlock will appear in the centre display.

When you operate this feature with CombiDrive, you can also check the OLP release timer  00:05 and the waiting timer  00:30 on the display.



## 6.5. Hydraulic connections

You can disconnect a hydraulic line or a hose only for specific operator's tasks (for example, disconnecting the interchangeable equipment).



### DANGER

- STAY AWAY from oil leaks in the hydraulic system! Oil in the hydraulic system is under high pressure, can spill, be very hot and cause you injury.
- Do not replace any hydraulic hoses or lines yourself.



### WARNING

- Switch off the control system and the PTO before connecting or disconnecting the electrical and hydraulic connections.
- Keep the electrical and hydraulic protection caps and plugs in good condition and store them in a safe place.

### 6.5.1. Hydraulic quick couplings [option]

Hydraulic quick couplings allow a faster connection and disconnection of each hydraulic line.



### WARNING

- Switch off the control system and the PTO before connecting or disconnecting the connectors.
- Always remove/attach first the electrical connection before the hydraulic connection.
- Keep the electrical and hydraulic protection caps and bypass in good conditions and store them in a safe place.

**To connect the hydraulic quick couplings you must:**

1. Switch off the control system.
2. Disengage the PTO.
3. Remove the protection caps.
4. Connect the respective hydraulic quick couplings taking care with the corresponding identification:
  - Yellow and blue collars = 5th function
  - Red and green collars = 6th function

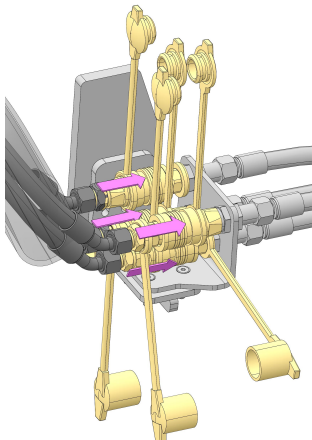

**NOTE**

To prevent damage, do not change the hydraulic quick couplings position.

5. Reconnect the PTO and switch on the system, if needed.
6. Do a functional test of all movements of the interchangeable equipment to verify that there are no mistakes in the connections.

**To disconnect the hydraulic quick couplings you must:**

1. Switch off the control system.
2. Disengage the PTO.
3. Disconnect the hydraulic couplings, and protect them with protective caps.
4. Reconnect the PTO and switch on the system, if needed.
5. Operate the crane to verify that all functions work correctly.

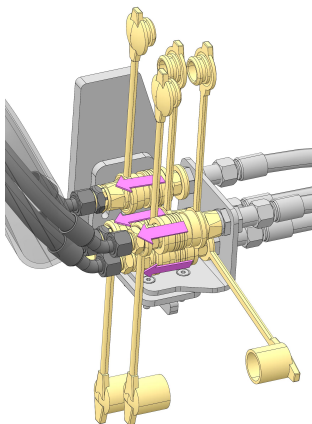



## 6.5.2. Hydraulic quick couplings (MULTI-X) [option]

Hydraulic quick couplings allow the connection of several hydraulic lines at the same time.



### WARNING

- Switch off the control system and the PTO before connecting or disconnecting the connectors.
- Always remove/attach first the electrical connection before the hydraulic connection.
- Keep the electrical and hydraulic protection caps and bypass in good conditions and store them in a safe place.

#### To connect the hydraulic quick couplings you must:

1. Switch off the control system.
2. Disengage the PTO.
3. Remove the protection caps.
4. Turn the lever to the upper position to allow the hydraulic connection.
5. Connect the hydraulic quick coupling MULTI-X (1).
6. Turn the lever to the lower position (2). Make sure that the lever locks the connection correctly.
7. Reconnect the PTO and switch on the system, if needed.
8. Do a functional test of all movements of the interchangeable equipment to verify that there are no mistakes in the connections.

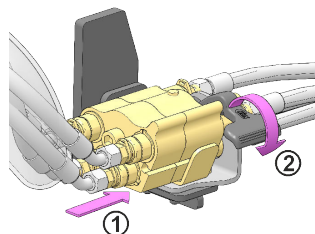

#### To disconnect the hydraulic quick couplings you must:

1. Switch off the control system.
2. Disengage the PTO.
3. Turn the lever to the upper position (1).
4. Disconnect the hydraulic couplings (2), and protect them with protective caps.
5. Turn the lever to its initial position.
6. Reconnect the PTO and switch on the system, if needed.
7. Operate the crane to verify that all functions work correctly.

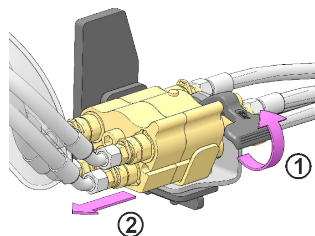

## 7. Ending crane operation

### 7.1. SAF Semi Automatic Folding [option]

SAF is a feature which allows the operator to fold or unfold the boom system in one single sequence using only one lever.



#### Fold the boom system semi automatically



#### WARNING

Never use SAF with mounted tools.



#### WARNING

Make sure there is enough space for the boom system to unfold/fold semi automatically. If the situation does not allow SAF, use crane mode to operate the boom system out of/into the parked position.

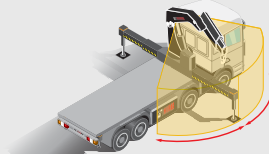

#### WARNING

If your crane has **manual extensions**, make sure that they are totally retracted or removed before operating the crane with the SAF feature.



#### WARNING







If your crane has **long JIB support**, make sure that it is totally retracted before operating the crane with the SAF feature.

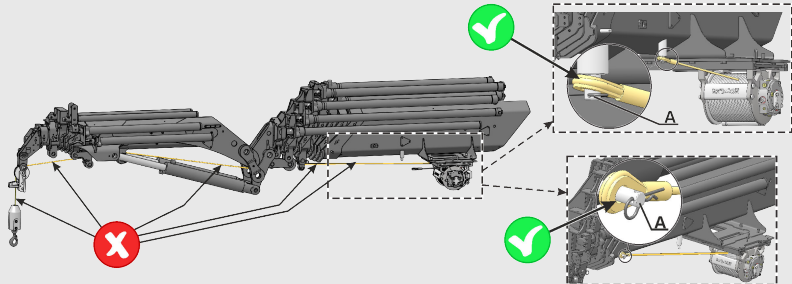

## WARNING



If your crane is equipped with a hoist, change from hoist to hook operation. Displace the hoist, if needed, to the outside position before operating the crane to parking position with JIB and hoist. Make sure that the rope is on the 2nd boom support and does not pass through any pulley. If not, remove the rope from the pulleys and fit it in the 2nd boom support (A) before operating the crane with the SAF feature.





1. Select menu for SAF on the controller.
2. If SAF is not configured in a separate menu, push button  to activate it.
3. Operate lever on the controller until the extensions are fully retracted:
  - XSDrive  or 
  - CombiDrive 
4. Confirm on the controller that the extensions are totally retracted:
  - XSDrive 
  - CombiDrive 



## NOTE

If you stop the SAF sequence, remember that when you start it again, the crane will not move. You must push the confirm button/lever  or  on the controller to continue with the sequence. Push this button/lever once, because it activates/deactivates the SAF sequence. So, if you push the button twice you will need to push it again to continue with the SAF sequence.

5. Continue operating lever on the controller until the boom system is totally folded:
  - XSDrive  or 
  - CombiDrive 



### DANGER

Pay careful attention when using this feature.

Always maintain eye contact when operating the crane.

During this movement, the boom system will fold itself, release the lever immediately if the boom system is about to:

- Hit a person
- Hit an object
- Hit a moving obstacle that suddenly comes closer to the crane.

6. If SAF is not configured in a separate menu, push button  to deactivate SAF.

## 7.2. Operate the boom system into transport position



### WARNING

- A crane with interchangeable equipment and/or optional components can differ from the operations described in this section. For this reason, study the operating instructions for any interchangeable equipment and/or optional components carefully.
- You must disable the SDC (Synchronize Distance Control) feature when you fold or unfold the boom system. Use the hoist function to wind or unwind the rope during these operations.



### DANGER

- During folding of the boom system, always operate the crane manually from the position indicated in the figure.
- With remote controlled cranes, stay in a safety area while the boom system is moving.



## 7.2.1. Operate the boom system

### EFFER iQ.950-1200 HP



#### NOTE

SAF option is possible with this crane configuration.

1. Retract the extensions completely (1).
2. Raise the 1st boom (2) until BDA allows you to operate the 2nd boom or  $\beta > 135^\circ$ .
3. Slew the crane (3) to parking position. Check that arrows “A” are aligned.  
LED for the parking control **P** will light blue on the User Interface [If fitted].
4. Operate the 2nd boom against the 1st boom (4) .



#### CAUTION

Pay careful attention not to damage the slewing motors.

5. Lower the 1st boom completely (5). Check if the parking support “B” rests on the slot “C”.  
When the stabiliser extensions are retracted, the catcher “D” will lock the 1st boom and hold the boom system in parking position.

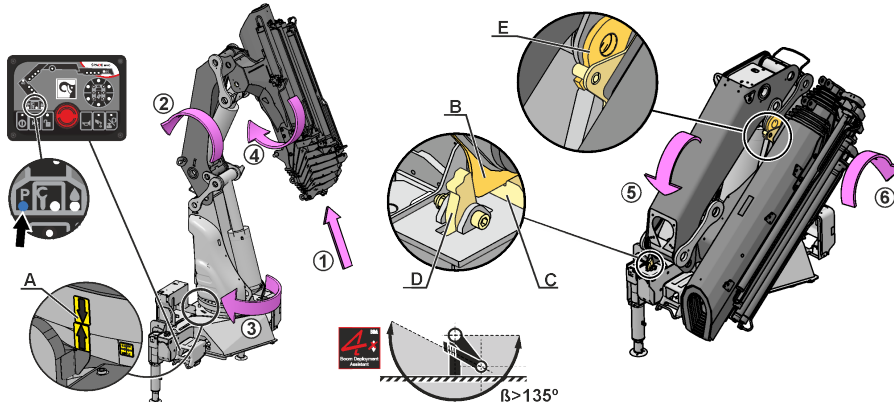

#### CAUTION

Do these operations slowly to not damage the parking supports.

6. Release OLP.   
Press the release button on the controller for remote control operation or on the User Interface for manual operation.

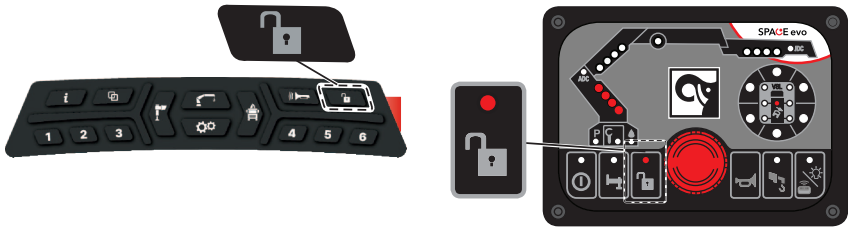

7. Operate the 2nd boom (6) against the support "E" until it has contact with the support.



**CAUTION**

Take care not to damage the 2nd boom and the support during these operations.

8. Fold the hook.

### 7.3. Placing the stabiliser system in the transport position



**DANGER**

Do not stand in the stabiliser legs, tilting area.



**WARNING**

Do not put your foot on the support plate.

Risk of crushing injuries.

Always keep hands away from moving parts during operation.



The procedure of operating the stabiliser legs can differ depending on the type of stabiliser leg. Repeat the instructions for the stabiliser extension and leg on the other side of the vehicle. For auxiliary stabiliser system [option]: Repeat the process.





**DANGER**

Always ensure that the stabiliser legs and the stabiliser extensions are in transport position and securely locked before moving the vehicle.

- **Manually controlled crane:**

Activate stabiliser system operation on the User Interface by pressing button .

- **Remote controlled crane:**

- **Manually controlled stabiliser system:** Press button  on the User Interface to deactivate the controller. Activate stabiliser system operation on the User Interface by pressing button .
- **Remote controlled stabiliser system without the CD4 confirmation view sensors:** Select on the controller the defined menu for the stabiliser system operation. Activate stabiliser system operation on the User Interface by pressing button .
- **Remote controlled stabiliser system with the CD4 confirmation view sensors:** Select on the controller the defined menu for the stabiliser system operation.

### Non-tiltable stabiliser legs

1. If there is an extra support plate (1) for the leg delivered, retract the stabiliser leg a little, if not, go to step 3.
2. Remove the extra support plate (1).
3. Retract the stabiliser leg completely.
4. Retract the stabiliser extension completely. Follow the procedure: "Retract the stabiliser extensions".

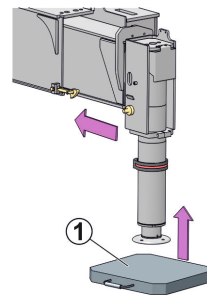

#### WARNING

Risk of crushing injuries.

Always keep hands away from moving parts during operation.

## Hydraulically controlled tiltable stabiliser legs



### DANGER

Do not stand in the tilting area. Make sure the leg remains unlocked during the complete tilting.

1. If there is an extra support plate (4) for the leg delivered, retract the stabiliser leg a little, if not, go to step 3.
2. Remove the extra support plate (4).
3. Pull out the locking pin (1) and turn the lever (2) 180°.
4. Operate the stabiliser leg lever. The stabiliser leg (3) will now rotate automatically to vertical position.
5. Turn the lever (2) -180° and check that the locking pin (1) is in and the lever (2) cannot rotate.

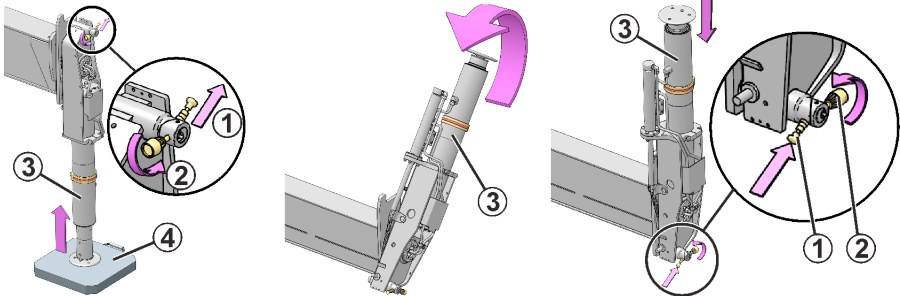

6. Fully retract the stabiliser leg (3).



### WARNING

Make sure that the stabiliser leg is in an upright position and properly locked.

7. Retract the stabiliser extension completely. Follow the procedure: "Retract the stabiliser extensions".



### DANGER

- Risk of crushing injuries.
- Always keep hands away from moving parts during operation.
- Make sure that the stabiliser leg is in an upright position and properly locked before starting to retract the stabiliser extension, if not, this could lead to serious personal injury, or death.



## Retract the stabiliser extensions

The procedure of retracting the stabiliser extensions differs depending on the type of stabiliser extensions. Repeat the instructions for the stabiliser extension on the other side of the vehicle. For auxiliary stabiliser system [option]: Repeat the process.

### Hydraulically controlled stabiliser extensions



#### DANGER

Before you retract the stabiliser extensions:

- Make sure that you can see them clearly during their operation.
- Be prepared to reduce the speed of the operation to prevent accidents.
- Make sure that the stabiliser legs are fully up and locked.

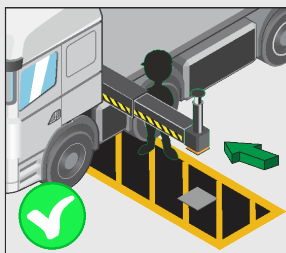
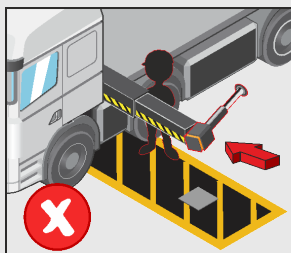

Retract the stabiliser extensions with the levers on the valve or the controller depending on your crane configuration. Make sure that the stabiliser locking device (1) (if fitted) is securely locked.

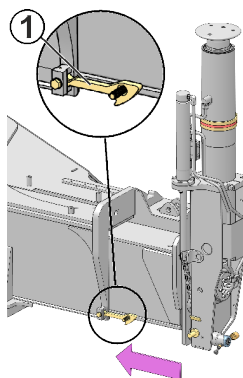
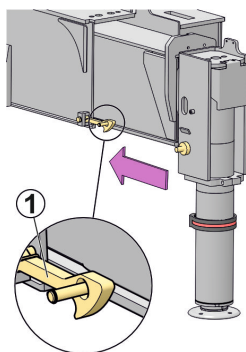

#### WARNING

Always ensure that the stabiliser legs and stabiliser extensions are in transport position and securely locked.

## 7.4. Switching off the control system

- Switch off the control system with the ON/OFF button .

### If you are using the remote controller:

- Push the emergency stop button on the controller and switch off the control system.
- Disengage the PTO.

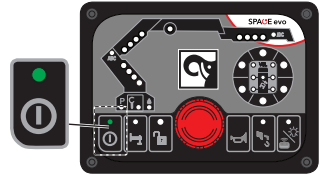

## 7.5. Emergency operation

### 7.5.1. EMERGENCY operation to bring the crane to transport position



#### DANGER

- The use of any emergency operation is under your direct responsibility as operator of the crane.
- You must be qualified and correctly trained in the emergency operation. Pay careful attention when operating from the operator station (crushing, falling, etc...) and watch out for hidden hazards (low visibility, narrow spaces, etc...).
- Always operate the crane with caution and at reduced speed.
- To operate the crane like this is HIGHLY DANGEROUS because during emergency operation, the crane safety system is disconnected. There is a high risk of the truck overturning.
- It is strictly forbidden to use any emergency operation as normal operation (for example lifting a load).
- Always go to/contact an authorised service workshop when a security seal has been broken.

#### Do like this:

1. Engage the pump.
2. Break the security sealing on (1) Dump valve 1 on the supply unit.
3. Use a screwdriver (or similar) and push the knob on (1) Dump valve 1.
4. Check that no unintended movements start. If you get unintended movements then release the knob and contact an authorised service workshop.
5. Push the dump valve knob and turn 90 degrees until it is blocked.

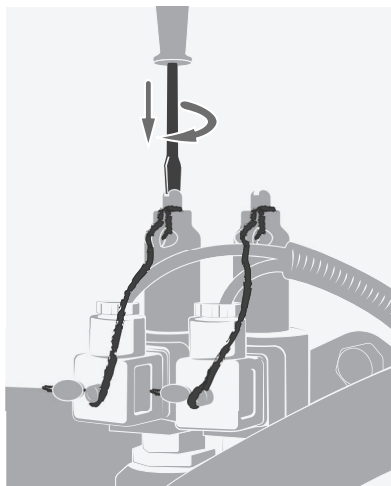
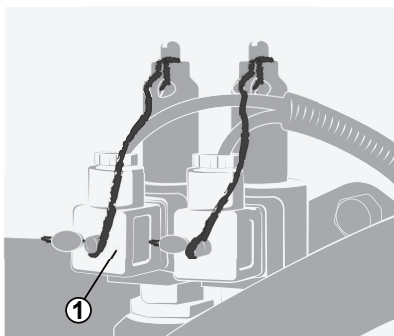

6. Operate the crane to transport position:



**DANGER**

- Always use the controller for this operation if it is possible.
- With the crane safety system disconnected:
  - First, you must fully retract all the boom extensions, crane and JIB [option].
  - You must not operate any function which increases the load moment or causes a worse stability situation.
  - If the crane is with a load, do not raise the 1st or the 2nd boom. Carefully lower the 1st and/or 2nd boom to release the load on a flat and firm surface.

- a. If **electrical power supply is available**, always **use the controller** to bring the crane to a safe transport position.



**DANGER**

Stay in a safety area during this operation.

- b. If **electrical power supply is not available**, **use the levers on the main control valve** or **the separate emergency lever supplied** to bring the crane to a safe transport position.



**DANGER**

To operate the crane like this is **HIGHLY DANGEROUS**, always operate the crane with caution and at reduced speed.

## 7.5.2. EMERGENCY operation to bring the stabiliser system to transport position



### DANGER

- The use of any emergency operation is under your direct responsibility as operator of the crane.
- You must be qualified and correctly trained in the emergency operation. Pay careful attention when operating from the operator station (crushing, falling, etc...) and watch out for hidden hazards (low visibility, narrow spaces, etc...).
- Always operate the stabiliser system with caution and at reduced speed.
- To operate the stabiliser system like this is **HIGHLY DANGEROUS** because during emergency operation, the crane safety system is disconnected. There is a high risk of the truck overturning.
- It is strictly forbidden to use any emergency operation as normal operation (for example lifting a load).
- Always go to/contact an authorised service workshop when a security seal has been broken.

#### Do like this:

1. Follow the procedure: [Section 7.5.1: EMERGENCY operation to bring the crane to transport position \(page 106\)](#). The knob on dump valve 1 on the main control valve is to remain depressed.
2. Break the security sealing on (2) Dump valve 2 on the supply unit.
3. Check that no unintended movements start. If you get unintended movements then release the knob and contact an authorised service workshop.
4. Push the dump valve knob and turn 90 degrees until it is blocked.

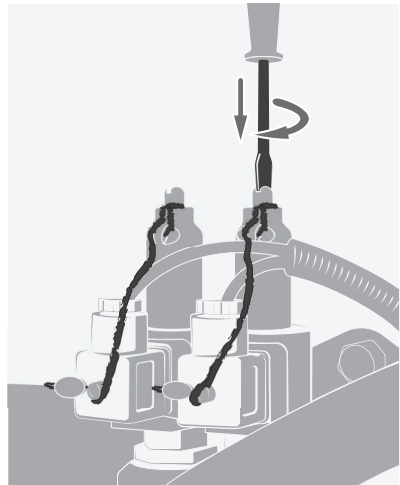
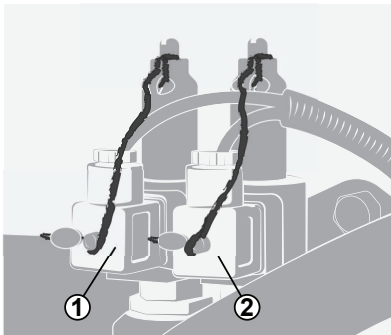

5. Operate the stabiliser system to parking position:
  - a. If **electrical power supply is available**, always **use the controller** to bring the stabiliser system to a safe transport position.

**DANGER**

Stay in a safety area during this operation.

- b. If **electrical power supply is not available**, **use the levers on the main control valve** or **the separate emergency lever supplied** to bring the stabiliser system to a safe transport position.

**DANGER**

To operate the stabiliser system like this is **HIGHLY DANGEROUS**, always operate the stabiliser system with caution and at reduced speed.

### 7.5.3. Separate emergency lever [option]

This separate emergency lever is supplied from the factory, together with the crane documentation.

**NOTE**

- Keep this emergency lever in good condition.
- Store it in a safe and accessible place in the vehicle.
- Use it only in case of an emergency operation needed.

- Use the emergency lever according to the procedures for emergency operations.
- Remove the covers to operate the emergency lever when required.
- The signs next to the control valve show the different movements for each function.

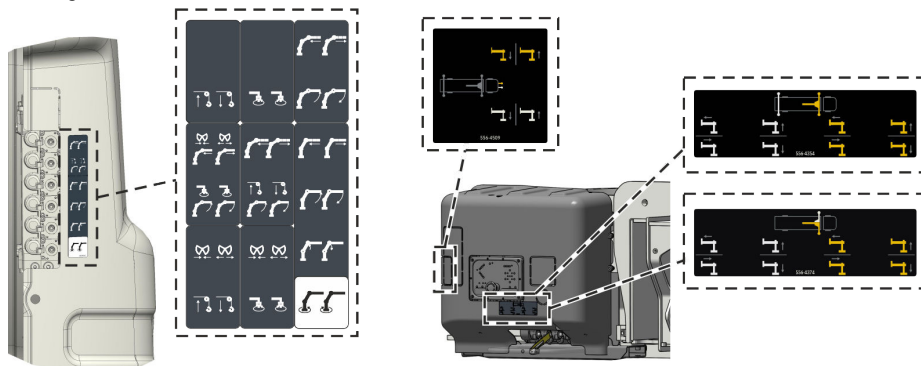

### Emergency lever with the control valve V200 (crane functions)

You must use this side of the emergency lever to operate this control valve

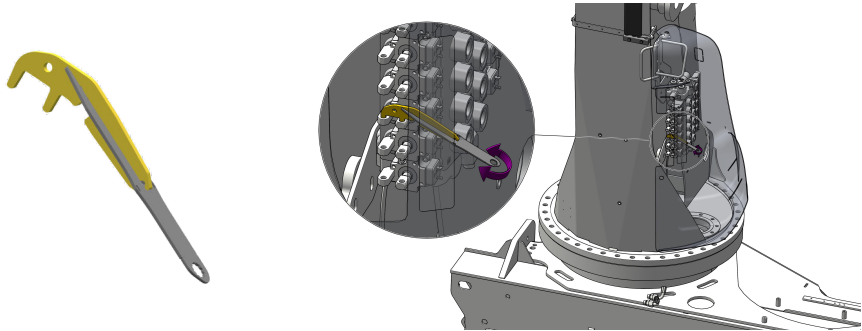

### Emergency lever with the control valve V80R (stabiliser functions)

You must use this side of the emergency lever to operate this control valve

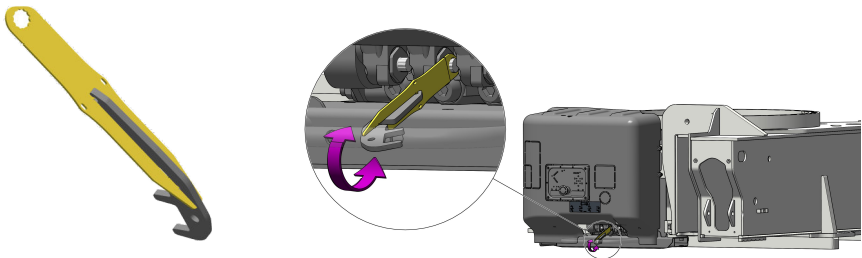

## 7.6. Transport warning



### WARNING

If you switch off the safety system when stabiliser extensions/stabiliser legs are not locked in the transport position, and/or if the 1st boom angle exceeds a certain specified angle, the indicator LEDs on the UI for both the cylinders and the hoist will flash red for a while.

**The vehicle must not be moved.**

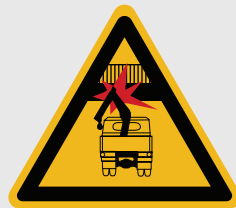

- A warning, visible and audible from the driving position for transport, indicates when the crane height exceeds a predetermined maximum and when the stabiliser extensions/stabiliser legs are not locked in the transport position.
- The audible warning can be silenced by an acknowledgement button [option] or by a signal indicating that the parking brake of the vehicle is engaged.

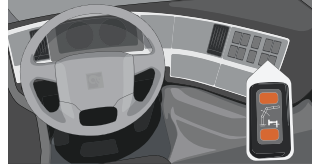

### The vehicle must not be moved

1. Switch the system on and operate the crane into transport position.
2. Switch off the system. The vehicle may be moved.



### DANGER

After use always put the crane into the transport position! When you have to park the boom on the load bed, or over the load, secure the boom and the lifting accessories and/or interchangeable equipment to prevent any unintentional movement of them.

### Driving with the crane

The position of the stabiliser system and the crane height are constantly monitored during transport.

If the control system detects a change in the stabiliser system position and/or an incorrect crane height, the driver will see and hear a warning.

## 8. Maintenance and Service

### 8.1. Service

#### No welding/drilling work on the crane



#### DANGER

- Do not do any welding work on the crane. Welding work on the crane may only be carried out by an authorised service workshop.
- Do not drill into the crane yourself. Drilling work on the crane may only be carried out by an authorised service workshop.
- Never try to reinstall the crane. Only an authorised Installer may reinstall the crane.



#### Leakages



#### DANGER

- STAY AWAY from oil leaks in the hydraulic system! Oil in the hydraulic system is under high pressure, can spill, be very hot and cause you injury.
- Do not replace any hydraulic hoses or lines yourself.

You can disconnect a hydraulic line or a hose only for specific operator's tasks (for example, disconnecting the interchangeable equipment).

1. Make sure that the cylinders are not at the end of stroke and minimise as much as possible the forces acting on them.
2. Switch off the system.
3. Disengage the PTO.
4. Make sure that you wear the correct personal protective equipment.
5. Move all levers in both directions to the end of the stroke to release all the pressure in the line.
6. Slowly loosen all connectors.
7. If they do not come out easily, you have remaining pressure in the line. Stop and do step 5 again.

#### Deal with an oil leak as follows:

1. Rest the crane on the floor or on the truck platform.
2. Switch off the control system.
3. Disengage the PTO.



**Leaking coupling:**

- a. Tighten the coupling with a spanner.
- b. If tightening does not help, contact an authorised service workshop.

**Small leak on a line or hose:**

- a. Determine if you can still park the crane.
- b. If you can, park the crane and go to an authorised service workshop.
- c. If you cannot, contact an authorised service workshop.

## 8.2. Warranty

The Seller only provides Warranty if the conditions specified in the "Service and Warranty Manual" are fulfilled.

Refer to the Service and Warranty Manual of your Product.

## 8.3. Follow the maintenance instructions!

Take the crane to an authorised service workshop for inspection and maintenance. Maintain lifting accessories and interchangeable equipment according to the supplier's instructions.

**WARNING**

- Make sure that faults in the crane are corrected immediately!
- All other faults must be corrected by personnel in an authorised service workshop!
- Carry out yourself only the service and maintenance work you have the requisite knowledge and experience for. Maintenance must be performed by qualified personnel.
- Always use personal protection devices and other safety means during the maintenance work in compliance with the regulations of the country in which you use the crane.
- All personnel must understand and comply with all warning and instructional decals attached to the body, crane and truck controls.
- Mark out the working area and make sure that there are no unauthorised persons inside.
- NEVER walk or stand under a crane or a suspended part. People may suffer fatal crushing injuries!
- When working on any part of the crane, put the "Out of Service" tags displayed clearly and wherever possible on the vehicle, and remove the ignition keys to prevent accidental operation.

**NOTE**

- Make sure that you have read the complete manual before starting the preventive maintenance. It provides detailed information about the maintenance process.
- Make sure that the manual and other documentation are in good condition, near the machine and available for anyone who needs it.

**Maintenance intervals:**

- Carried out by the **operator: daily and monthly inspection.**
- Carried out by an authorised service workshop:
  - **1st service:** to be made after 50 hours of use.
  - **Regular service:** to be made when one of these conditions are met:
    - 1,000 hours of use
    - 10,000 cycles
    - 365 days

**NOTE**

The service indicator on SPACE (if present) will light up for the 1st and regular service.

**NOTE**

Refer to the "Service and warranty manual" to know the actions performed by the authorised service workshop.

**Long storage of the crane**

If you need to store your crane for a month or longer, do this first:

1. Clean it according to the instructions in the section "Cleaning" of this manual.
2. Lubricate it according to the lubrication schedule of this manual.
3. Put the crane into transport position and disconnect the power from the vehicle battery.
4. Put grease on the exposed piston rod(s) and the external seals of the hydraulic cylinders.
5. Put a plastic cover on the crane.
6. Protect it from rain, sun and dirt as much as possible.

**Cleaning**

Clean your crane regularly, but:

- Always set the power off before you start.
- Do not use aggressive cleaning agents.
- If you use a high pressure water jet, make sure that:
  - Maximum temperature of the cleaning water is 60°C (140°F).
  - Maximum working pressure is 150 bar.
  - Minimum distance between the nozzle and the surface to clean is 80 cm.

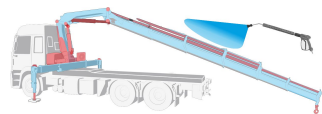
**CAUTION**

Never use a high pressure water jet on electronic parts, plastic components, signs, bearings, control valves, cylinders or the oil tank. Only the cranes surface may be cleaned with a high-pressure jet cleaner.

**NOTE**

Always lubricate after cleaning the crane.

**WARNING**

Keep the devices to go into the control station (handles, supports, platforms...) clean from oil, grease and dirt to prevent slipping and falling.

**8.3.1. Daily inspection**

Refer to the daily inspection checklist at the end of this manual to photocopy.

**Presence of signs and symbols**

- See chapter "Safety precautions and warnings" under section "Signs on the crane". Make sure that all the signs shown in section "Signs on the crane" are in position and in good conditions.
- Make sure that all the symbols on your crane are in good conditions.

**Locking devices**

- Make sure that all locking devices are undamaged and working properly.
- Make sure that all locking devices are properly locked.

**Spirit level**

- Make sure that the spirit level is clearly visible to the operator and works correctly.

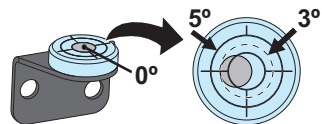
**Shafts, shaft locking, bearings and bushings**

- Check that the shafts, shaft locking, bearings and bushings are undamaged and working properly.

**Emergency stop buttons**

- Check that the emergency stop buttons are undamaged and working properly.

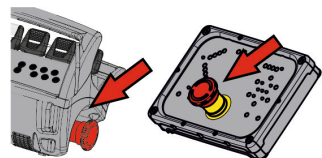
**Levers**

- Check that the levers operate smoothly.
- Check that the levers return to neutral position.
- Make sure that the separate emergency lever supplied [option], is in place and in good condition.

**Controller**

- Do a check of the controller functionality.

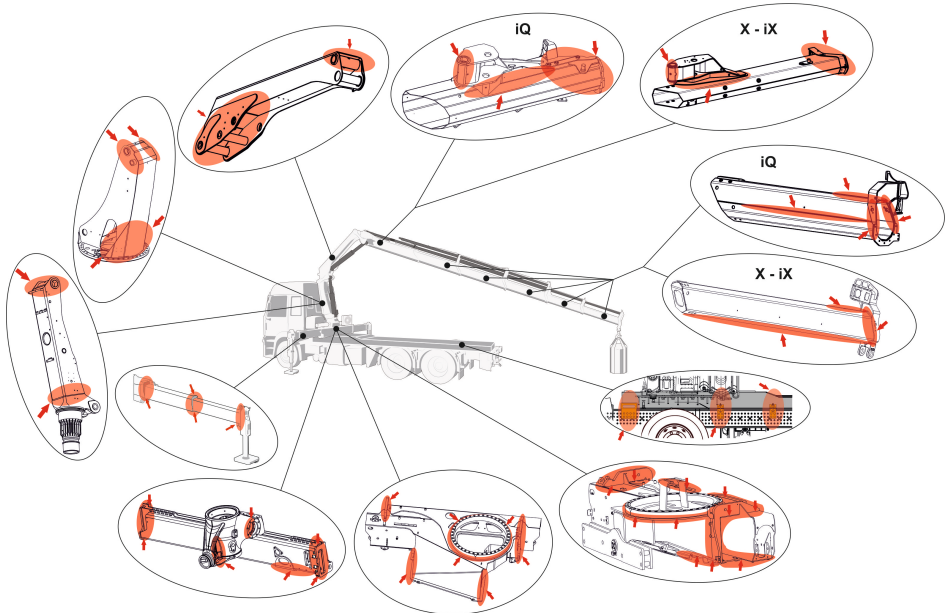
**Crane structure**

- Check for damage to the crane structure (e.g. any formation of cracks).

**DANGER**

In the event of damage that presents a safety risk:

- Do not use the crane.
- Have the damage repaired immediately by an authorised service workshop.

## Hooks

Always keep the hook clean. Use a cloth to wipe away any dirt.

Before every working shift:

- Do an inspection of the general conditions of the Hook (1) for deformation (stretched, cracked, twisted, excessive wear...) and surface damages with significant depth (such as from chemicals or heat).
- Do an inspection of the Clevis/Link Shaft (3) for damage/deformation.
- Do an inspection of the two Spring/Roll pins (8) and (9) that are in place and properly retaining the central hook nut (6).

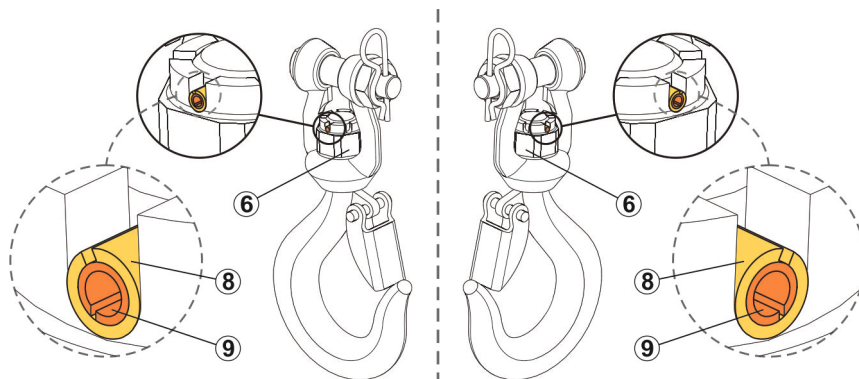
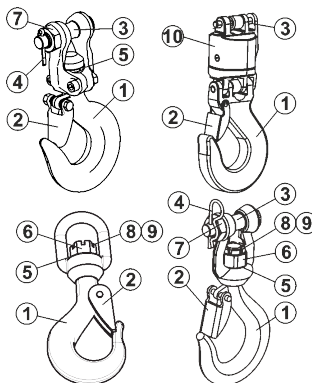

**Side 1**

**Side 2**

The two Spring/Roll pins (8) and (9) should be in place and nearly flush with the outer edge of the hook nut (6) on both sides. (See the pictures **Side 1** and **Side 2**).

- Do an inspection of the spring-loaded safety Latch (2). The Latch must close the entire throat opening.
- Do an inspection of the Clevis/Link Shaft (3), Clevis/Links Shaft nut (7) and Cotter/Safety pin (4) are in place.
- Do an inspection of the Plane bearing/Washer (5) or the Swivel (10) that is in good conditions.
- Do a general inspection for deformation and operation of the remaining items: clevis, swivels, washers, nuts, pins...
- Lubricate the hook according to the chapter "Lubrication of the hooks".



## DANGER

In the event of damage or worn to prevent a safety risk:

- Do not use the hook.
- Have the damage repaired immediately by an authorised service workshop.

## Lifting accessories, interchangeable equipment and optional crane components

- Check the cables, cable connections, the cable guides and the attachment points.
- Check the rope, rope connections, the rope guides and the attachment points.
- Maintain all lifting accessories, interchangeable equipment and optional crane components according to the instructions supplied with them.

## Electronic components

- Check that these are in good condition.
- Make sure that the horn works correctly.
- Do a check of the LEDs on the User Interface.

### LED Test on the UI box:

1. Push and hold the ON/OFF button for at least 3 seconds. The test is activated.
2. Release the button. The test starts showing all green LEDs, all red LEDs and all blue LEDs for 3 seconds per colour. The test is finished when all LEDs are off.

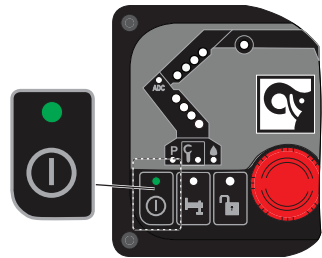

## Hydraulic system and oil level in the tank

- Check that there are no leaks from the hydraulic hoses, lines and connections.
- Make sure that all security seal wires (Ex. LHV, dump valves, etc...) are not broken. Always go to/contact an authorised service workshop when the seal wire has been broken.

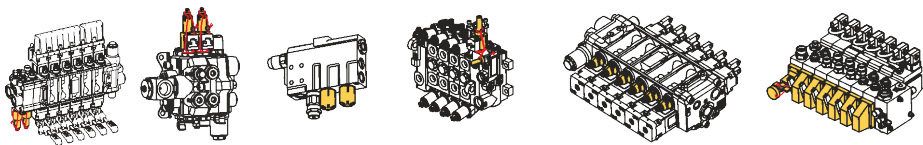
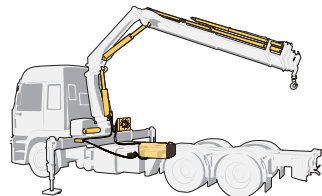

- Check oil level in the tank. If necessary, fill to correct level.

**NOTE**

Always place the vehicle on level ground with the crane in transport position while checking the oil.

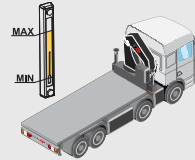
**Oil level in the slewing motors and condition**

- Do a check of the oil level in the gearbox of the slewing motors. If necessary, fill it to the correct level.
- Make sure that the slewing motors with the base attachment screws/bolts are not broken or loose. Check that they are in good condition and in place.

**DANGER**

If you find broken or loose bolts:

- Do not use the crane.
- Have the damage repaired immediately by an authorised service workshop.

**Filters**

- Check the filter indicator. If red, a workshop must replace the cartridge.

### 8.3.2. Monthly inspection and maintenance

**NOTE**

Refer to the monthly inspection checklist at the end of this manual to photocopy.

In addition to the daily inspection, carry out the following tasks each month:

**Piston rods**

- In cases where the cylinder piston rod is exposed to pollution due to the parking location, the chromed surfaces must be cleaned and oiled to prevent corrosion. This needs to be done regularly.

**Pivot pins and bushes**

- Inspect all the pivot pins and bushings for the crane boom and cylinders for damage, play, etc.

**Bolts and screw fixings**

- Check that bolt and screw fixings are tight. If not, contact an authorised service workshop

**Cables and sensors**

- Check that cables and sensors are in good condition.

**Lubrication schedule**

- Carry out the lubrication according to the instructions.

**Slewing bearing / upper column bearing**

- Check that the slewing bearing / upper column bearing is lubricated sufficiently.

**Hydraulic system**

- Check that the hydraulic pump attachment screws are tightened.
- Check if the oil in the hydraulic system needs to be changed, or have it tested by a workshop or a specialist.

**Lifting accessories, interchangeable equipment and optional crane components**

- Maintain all lifting accessories, interchangeable equipment and/or optional crane components according to the instructions supplied with them.

### 8.3.3. Annual maintenance

Take the crane, at least once a year, to an authorised service workshop for inspection and maintenance.

The workshop must carry out the following maintenance tasks at least once a year.

**Hydraulic oil**

- Change the hydraulic oil.





### NOTE

If the workshop is equipped and the personnel prepared to do a test of the oil quality and think that the oil change is not needed, they can postpone it on their own responsibility.

### Oil in the slewing gearboxes

- Change the oil in the slewing gearboxes, or have it tested by a workshop or a specialist.

### Hydraulic system oil tank filler cap

- Change the filler cap.
- Replace filters.

### Hooks

- Replace missing or faulty parts on link assembly: shafts, safety pins and nuts.
- Replace the hook for a new one if the hook is damaged.
- Replace the latch assembly if it is damaged, missing or malfunctioning.
- **Hook 8 t and 10 t (without spring/roll pins):** replace the hook for a new one if the clevis/link or split clevis retaining nuts are missing or damaged.
- **Hook 10 t (with spring/roll pins):** replace the two spring/roll pins and the plane bearing for a new ones, at least once a year.

### Slewing bearing

- Make sure that there are not unusual movements, noises, excessive clearance, etc... between the base and column when operating the crane.
- Make sure that the base with the column attachment (screws/bolts) are not broken or loose. Check that they are in good condition and in place.
  - External screw/bolts (1).
  - Internal screw/bolts (2), remove cover (3) and check the fastening bolts through the hole.

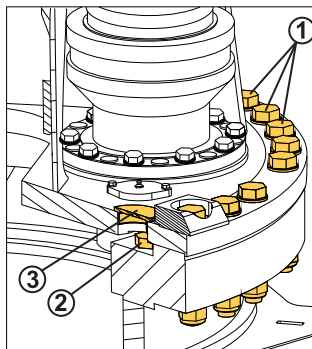

### DANGER

If you find broken or loose bolts:

- Do not use the crane.
- Have the damage repaired immediately by an authorised service workshop.



### WARNING

Effer strongly recommends doing this inspection every 6 months by an authorised service workshop.

## 8.4. Lubrication

### General greasing of the cranes

Incorrect or insufficient lubrication of a crane is the number one cause of premature failure.



#### WARNING

Before and after a long stop of the crane, lubrication is absolutely necessary. This is especially important after a winter shutdown.



#### WARNING

Follow the lubrication schedule exactly. If you do not do so, you can cause serious damage to the crane, interchangeable equipment and/or optional crane component.

Procedure:

1. Shut down the crane.
2. Make sure that all the lubrication points are clean before lubricating. Dirt can damage the parts.
3. Lubricate all points in each section.
4. Operate the crane through the full cycle for each section. Moving the lubricated parts is really important to get the full and correct lubrication of all moving components.
5. Shut down the crane and repeat the lubrication.
6. Lubrication is finished when the grease spills out from the ends. Clean the excess grease.



#### WARNING

Personnel should never attempt to work on a crane that is moving. Serious injury or death will occur if you try to work on an activated/moving crane.



#### CAUTION

When you use pressure grease pumps, open the plastic safety guard of the nipple and close it at the end.

### Greases

Use lithium-based grease containing EP additives (consistencies 2 and 3 are recommended, depending on the climate).



#### CAUTION

Do NOT grease with graphite or molybdenum-disulphide additives.



### Recommended greases:

BP LS EP 2, ESSO UNIWAY EP2 N, AGIP GR MU/EP3, NYNÄS UNIFETT EP.

### Alternative:

Use a Teflon grease spray to lubricate the extensions and mobile parts.

### 8.4.1. Lubrication schedule

	Lubricate after every 16 hours of use.
	Lubricate after every 50 hours of use.
	Grease after every 50 hours of use.

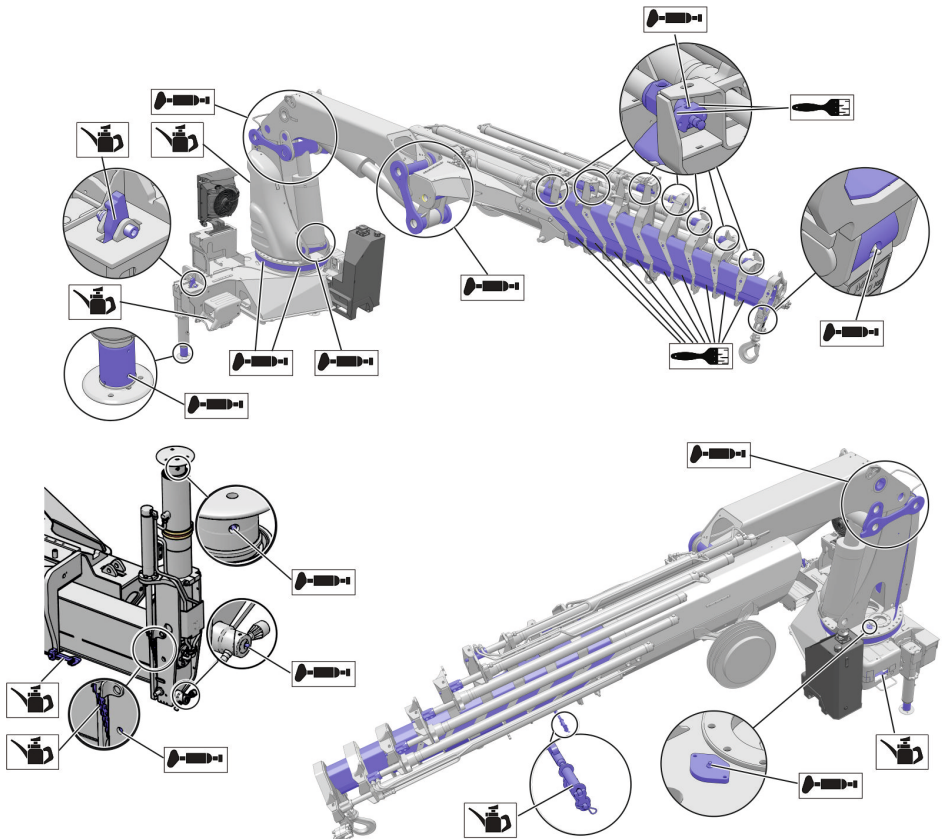

### 8.4.2. Greasing the slewing bearing (internal gear teeth)

1. Grease through the grease nipple in the cover (1).
2. Slew the crane a bit and grease again.
3. Make sure that the slewing bearing is fully greased:
  - a. Remove the cover (1) where the nipple is located.
  - b. Make sure that there is enough grease through the hole (2).
4. Install the cover again in the same direction.

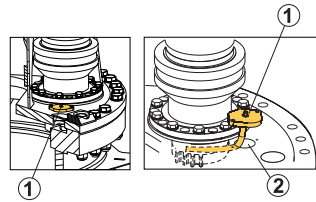

#### NOTE

The tube must point to the motor.

**Greases:** Use lithium-based grease containing EP additives (consistencies 2 and 3 are recommended, depending on the climate).



#### NOTE

Recommended greases for the slewing bearing are marked with the symbol  in the table.

### 8.4.3. Greasing the bearing assembly (raceway and inner balls)

The grease filling is there to reduce friction, seal the bearing and provide protection against corrosion.

- The operator has to grease the bearing assembly approximately every 100 working hours.
- Lubrication is made by injecting approximately 5 cm<sup>3</sup> into each grease nipple (1) around the bearing.

#### Greases:



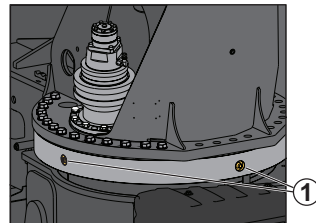







Use lithium-based grease containing EP additives (consistencies 2 and 3 are recommended, depending on the climate).



#### NOTE

Recommended greases for the bearing assembly are marked with the symbol  in the table.

#### 8.4.4. Greases for the slewing bearing and the bearing assembly

	□	◆		□	◆
	Aralub HLP2 248 K ↔ 403 K (-25° ↔ +130°)	Aralub MKA-Z 1 248 K ↔ 403 K (-25° ↔ +130°)		Energrease LS-EP-2 248 K ↔ 403 K (-25° ↔ +130°)	Energrease LC3 243 K ↔ 433 K (-30° ↔ +160°)
	Spheerol EPL 2 253 K ↔ 393 K (-20° ↔ +120°)	Viscogen 0 238 K ↔ 398 K (-35° ↔ +125°)		EPEXA 2 243 K ↔ 393 K (-30° ↔ +120°)	CADREXA GR 1-AL 243 K ↔ 393 K (-30° ↔ +120°)
	BEACON EP2 248 K ↔ 403 K (-25° ↔ +130°)	Esso Multi-Purpose Grease (Moly) 248 K ↔ 423 K (-25° ↔ +150°)		CENTOPLEX 2 EP 253 K ↔ 403 K (-20° ↔ +130°)	GRAFLOSCON C-SG 0 plus 243 K ↔ 473 K (-30° ↔ +200°)
	Mobilux EP-2 253 K ↔ 393 K (-20° ↔ +120°)	Mobiltac 81 243 K ↔ 393 K (-30° ↔ +120°)		Lagermeister EP 2 253 K ↔ 393K (-20° ↔ +120°)	Ceplattyn KG 10 HMF 243 K ↔ 523 K (-30° ↔ +250°)
	Shell Alvania EP 2 248 K ↔ 403 K (-25° ↔ +130°)	GREASE S.8327 253 K ↔ 503 K (-20° ↔ +230°)		Multifak EP 2 243 K ↔ 403 K (-30° ↔ +130°)	Spectron ZKF-EP 0 253 K ↔ 423 K (-20° ↔ +150°)

#### 8.4.5. Lubrication of slide pads in the boom system

Clean the surfaces and remove with a spatula all abrasive material (dirt, sand, shavings), and where possible, the old grease.

##### Side slide pads

- Extend all the extensions completely.
- Lubricate.
- Retract the extensions.

##### Upper slide pads

- Extend extensions with load to create enough clearance.
- Lubricate.

##### Lower slide pads

- Extend extensions without load and push slightly against the ground to create enough clearance.
- Lubricate.

##### Recommended greases:

- Side / upper / lower slide pads (**Green colour**):

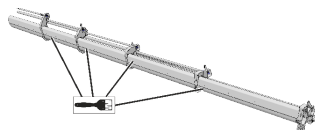



### CAUTION

Use **only** grease 'STABYL TA' with the slide pads 'TECAGLIDE PA6 C' (green colour).

- As a general use for cranes with KTL painting:
  - For cranes over 40 tm, use STABYL TA with TECAGLIDE slide pads.
  - For cranes below 40 tm, use a Teflon grease spray.



### NOTE

To prevent or correct malfunctions or the "stick-slip" of the boom extensions operation, we recommend lubricating the lower part of the extensions.

If you have any doubt, please contact your Effer representative.

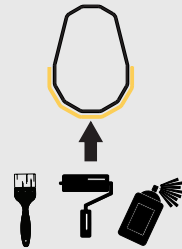

## 8.4.6. Lubrication of the hooks

### Hooks with plane bearing

If the hook cannot rotate easily without load:

- Put grease on the plane bearing surfaces (1).
- Use a heavy duty penetrating spray grease, type "ZEP 2000" or equivalent quality.

### Hooks with swivel

Put grease if the swivel cannot rotate easily:

1. Remove the screw (2) and mount a grease nipple.
2. Add grease until grease appears between house (3) and shank (4).
3. Mount the screw (2).

Use a bearing grease, type "Texaco Multifak EP 2" or equivalent quality.

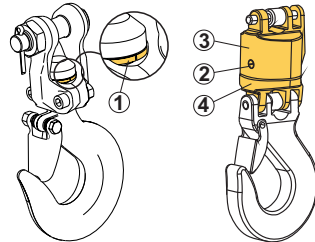

## 8.5. Checking and topping up oil levels

### 8.5.1. Slewing motors gearbox

#### Supplier recommendation:

Have the oil changed after the first 150 operating hours approximately. Then, repeat approx. every 2000 or 4000 operating hours depending on working conditions or at least once a year.

#### Recommended oil:

Use a hypoid oil, type API GL-5, SAE J2360 (Formerly MIL-L-2105), viscosity SAE-80W-90, cleanliness NAS 1638:8. For example: "ENI ROTRA MP 80W-90", "SHELL SPIRAX S2 A 80W/90" or equivalent quality.



### CAUTION

The oil used for filling must be clean. Do not mix different oils (a mixture will change the oil properties).

### Oil level checking and top up

1. Check if there is oil in the level glass (1).
2. If there is no oil, remove the plug (2).
3. Top up through the filling hole (2) with hypoid gear oil.
4. Mount the plug (2).

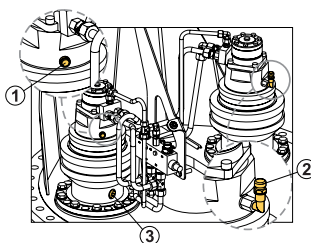

### 8.5.2. Checking of the oil level of the tank

1. Place the crane and stabiliser legs in the transport position.
2. Place the vehicle on level ground.
3. Check the oil level in the tank.
4. If the oil level is too low, top up with hydraulic oil.

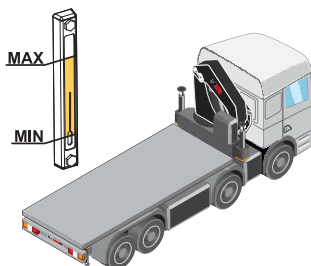

### Oil filling / Top up

1. Make sure that the required equipment to fill the tank is fully clean.
2. Put the crane in the parked position.
3. Clean the area around the oil filler cap.
4. Fill with oil up to the max level indicator.

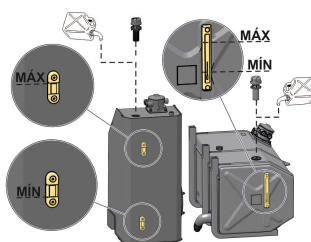

### CAUTION

- Never fill the tank completely, because during operation, the volume of the oil could expand as the temperature increases.
- Never use recycled oil!

## Filling the oil tank with hydraulic oil



### CAUTION

The oil used for filling must be clean. Do not mix different oils (a mixture will change the oil properties).

Hydraulic oils must have been dealt with according to cleanliness requirements ISO 4406: -/16/13.



The hydraulic oil approved for our products must comply with one of the following standards or equivalents:

- ISO 11158 HV
- DIN 51524 part 3 HVLP
- ISO 6743/4 L-HV

Verify with the supplier that the quality and performance of the hydraulic oil comply with the previous standards.

When changing from mineral oil to a non-polluting synthetic oil, or when changing to biodegradable oil, contact an authorised service workshop.

## Recommended hydraulic oils

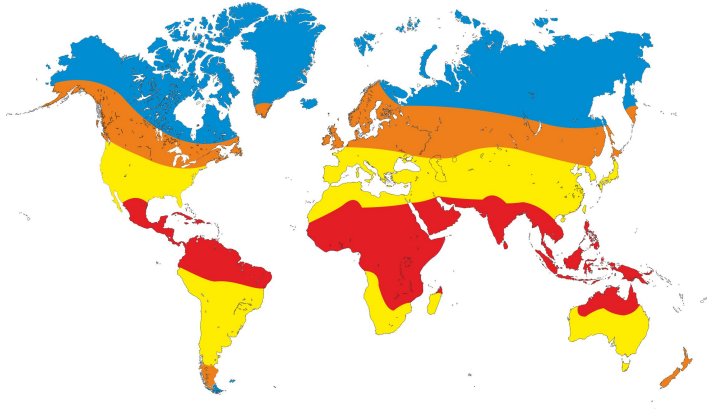
	ISO VG 32	ISO VG 46	ISO VG 68
Examples	Tellus S2 V32 Super 32 Hydrol L-HV 32	Shell TELLUS T 46 Texaco RANDO HDZ46 Agip ARNICA 46	Mobil SHC 526
Where to use them			
			

## Viscosity of oil

The viscosity of the oil is important to achieve high efficiency of the hydraulic system.

The naming of the oil in the table below: 32, 46 or 68 tells the viscosity of that oil at 40°C (104°F) (reference temperature).



Viscosity of oil at 40°C (104°F)	Temperature range
32	-25°C to 75°C (-13°F to 167°F)
46	-15°C to 90°C (5°F to 194°F)
68	-5°C to 90°C (23°F to 194°F)

The recommended viscosity during normal working conditions is between 16 and 40cSt.

Hiab strongly recommends an oil working temperature below 70 °C (158 °F). If necessary consider an oil cooler or heater.



### NOTE

If you need to work at a temperature below -25 °C (-13 °F), contact an authorised service workshop.

### Environmentally friendly oil

The environmentally friendly oils recommended are ester-based synthetic hydraulic fluids (synthetic ester).



### CAUTION

Vegetable oils do not meet Hiab requirements and must not be used.

### After filling the tank

1. Operate each crane function to its end positions.
2. Operate the crane to parked position.
3. Check and top up the oil tank to max level on the tank gauge.
4. Bleed the air from the hydraulic system.

## 8.6. Replacement of filters

Filter cartridges must be replaced by an authorised service workshop:

- After the first 50 hours operation
- Then after every 1000 hours operation
- Or at least once a year.

### *How do you verify if the filter needs a replacement?*

The high pressure filter is on the crane base, connected to the pressure line from the pump. It has an indicator (1) that turns red when the replacement is needed.

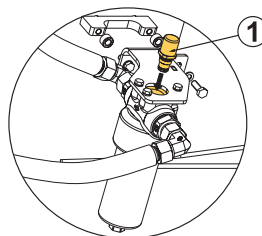

The return oil filter is on the oil tank, and can have a clogging indicator. This indicator turns red when needed. In all other cases (if the filter time is expired or without clogging indicator), you must follow the general recommendations for its replacement.

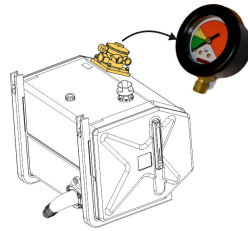

There are other filters on your crane (the pressure-reducer filter (1) on remote-controlled cranes, and the breathing filter (2) on the oil tank). These filters have no indicator and you must follow the general recommendations for their replacement.

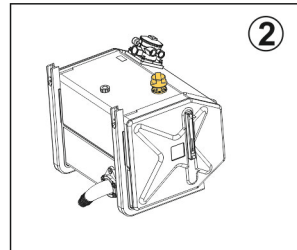
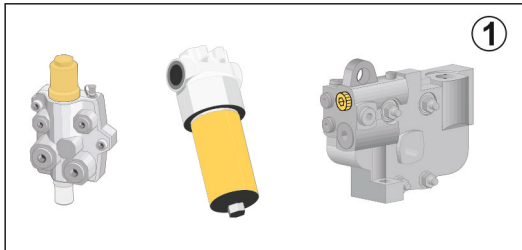

## 8.7. Bleeding air from the hydraulic system

**Bleed the air from the hydraulic system:**

- after changing the hydraulic oil
- after working on the hydraulic system
- if your crane works slowly or jerkily
- if your crane has not been used for a long time



### WARNING

Air in the hydraulic system can lead to faults and damage

**To bleed the air from the hydraulic system, proceed as follows:**

1. Slowly extend and retract each stabiliser extension to its end position at least two times.
2. Slowly extend and retract each stabiliser leg to its end position at least two times.
3. Set stabiliser system in working position and operate the crane out of parked position.
4. Slew the crane slowly.
  - If your crane has a rack-and-pinion slewing system, slew the crane in each direction to the slewing stop at least twice.
  - If your crane has a continuous slewing system, slew at least two complete rotations.
5. Slowly raise and lower the 1st and the 2nd boom to its end position at least twice.
6. If the crane is equipped with JIB, slowly raise and lower the JIB at least twice with main boom system pointing downwards and upwards.

7. Slowly extend and retract the boom extensions to their end position at least twice.
  - a. If your crane is equipped with JIB, extend and retract the 2nd boom extensions with the JIB pointing almost vertically upwards and downwards.
  - b. Slowly extend and retract the JIB extensions to their end position at least twice.
8. Slowly operate each hydraulically operated interchangeable equipment and/or optional crane components to their end position at least two times.



### CAUTION

Do not keep the lever engaged at the end position of each movement.

9. Check the oil level in the tank and top up if necessary.

## 8.8. Troubleshooting

### 8.8.1. Main fuses

If the processor detects a fault, this must be rectified immediately.

Fault	Probable cause	Action
<p>The control system does not work at all.</p> <p>The indicator light next to ON/OFF button on the User Interface is not lit, even if you push ON/OFF.</p>	<p>Defective fuses.</p>	<ol style="list-style-type: none"> <li>1. Replace faulty fuses in the:               <ul style="list-style-type: none"> <li>- vehicle</li> <li>- vehicle interface box (VIB)</li> <li>- relay box</li> </ul>               (See Description, Fuse, Location)             </li> <li>2. Check all the cable connections.</li> </ol>

Item	Description	Fuse	Location
(1)	Main fuse to protect the entire crane system.	35-40 A	Located on the vehicle where the crane is mounted (X).
(2)	Fuse to protect all components controlled by the Vehicle Interface Box (VIB).	20 A	Located inside the VIB (Y).
(3)	Fuse to protect the main ECU, boom connectors, JIB and Gateway.	10 A	Located inside the VIB (Y).
(4)	Fuse to protect the relay box.	15 A	Located inside the VIB (Y).
(5)	Fuse to protect the oil cooler.	15 A	Located inside the VIB (Y).
(6)	Fuse to protect the slave ECUs.	10 A	Located inside the VIB (Y).
(7)	Fuse to protect the system on, constant power, power feed to ECU.	2 A	Located inside the VIB (Y).
(8)	Fuse to protect the Gateway.	5 A	Located inside the VIB (Y).
(9)	Fuse to protect all components controlled by the relay box.	15 A	Located inside the relay box (Z).

### 8.8.2. Faults on the crane

Faults in the crane must be rectified immediately.





#### DANGER

- Only correct yourself the faults that according to the table you may rectify.
- Follow the instructions exactly!
- All other faults must be corrected by personnel in an authorised service workshop!

Fault	Probable cause	Action
Control system will not start.	Parking brake on the truck is not engaged.	Engage parking brake on the truck.
The hydraulic pump makes a noise. <b>Warning! Stop using the crane immediately!</b>	Oil tank filler breather is clogged.	Clear the blockage or replace the entire filler cap.
	Oil level in the tank is too low.	Top up the oil tank and bleed the hydraulic system.
	Hydraulic pump is faulty.	Go to an authorised service workshop.
Leak on hydraulic system: leaking coupling, hose or line. <b>Danger! Keep away from any oil leak.</b>		1. Push in the Stop button [If fitted].
		2. Disengage the PTO.
		3. Contact an authorised service workshop.
Stabiliser extensions do not slide out.	Stabiliser extensions are still locked.	Unlock the stabiliser extensions.
	Hydraulic fault.	Go to an authorised service workshop.
The stabiliser extensions do not slide out/in. (Chain-driven stabiliser system)	Incorrect chain tension.	Contact an authorised service workshop.
The stabiliser leg cylinder cannot keep the truck load and it goes inwards.	Check valve damaged.	Go to an authorised service workshop.
	Cylinder internal leakage.	Go to an authorised service workshop.
	Soft ground surface.	Set again the stabiliser led onto the ground or add an extra support plate between the cylinder and ground.
Slewing support cylinders do not turn	Three-way valve failure.	Go to an authorised service workshop.
Irregular slewing movements and unusual noises in cranes with rack and pinion slewing system.	Insufficient oil in the hydraulic system.	Top up the oil tank.
	Insufficient oil in the slewing housing.	Top up the oil in the slewing housing to the required level.
	The upper slewing bearing is not properly lubricated.	Lubricate the bearing.

Fault	Probable cause	Action
	The bearings in the slewing housing are damaged.	Go to an authorised service workshop.
Irregular slewing movements and unusual noises in cranes with continuous slewing system.	Insufficient oil in the hydraulic system.	Top up the oil tank.
	Insufficient oil in the gearbox.	Top up the oil in the gearbox to the required level.
	Bearing assemblies and pinion are not properly lubricated.	Lubricate the bearing while slewing.
	Bearing assemblies or pinion is damaged.	Go to an authorised service workshop.
One function of the controller does not work.	One lever of the controller was not in neutral at start up.	1. Push in the Stop button.
		2. Make sure that all levers are in neutral.
		3. Release the Stop button.
Crane does not react to controls. Indicator lamps light up on the User Interface.	The crane is in an OLP situation.	Perform movements to reduce the load moment. If necessary, release OLP.
Crane does not work properly:  One or more crane functions do not work, or not properly.  Lifting capacity is much less than normal. Operating speed is significantly reduced.  The service lamp is lit.	The system has detected a fault.	Contact an authorised service workshop.
Cane performance when operating it with the controller is unsatisfactory.	The pressure-reducer filter is clogged.	Replace the pressure-reducer filter.
Boom system cannot keep the load height, and it goes down by itself.	Load holding valves on the 1st boom or 2nd boom damaged.	Go to an authorised service workshop.
	Cylinder internal leakage.	Go to an authorised service workshop.
Boom extension cylinders do not follow the sequence.	Cylinder internal leakage.	Go to an authorised service workshop.

Fault	Probable cause	Action
Boom extensions shake during extending/retracting function.	Cylinder internal leakage.	Go to an authorised service workshop.
	Sequence screw in cylinder head loose.	Tight the screw in the right position.
Boom extensions cannot keep the load height and they move out by themselves.	Extension load holding valve damaged.	Go to an authorised service workshop.
	Cylinder internal leakage.	Go to an authorised service workshop.
Interchangeable equipment does not work properly (JIB, grapple, rotator, etc.)	Connectors not properly connected.	Reconnect the interchangeable equipment according to the instructions.
	Other defect.	Go to an authorised service workshop.
(Option) when using the SAF feature:  The sequence for unfolding/folding the boom system stops and does not finish.	The system has detected an internal error with the feature.	Use crane mode to fold/unfold the boom system.
(Option) when using the SAF feature:  Crane with boom extensions fully retracted does not continue with the folding sequence.	The feature needs the confirmation from the operator that the boom extensions are fully retracted.	Push the button/lever  or  on the controller to confirm that the boom extensions are fully retracted.
The crane does not move, and the LED for the dump valve on the UI does not stop blinking.	Dump monitoring failed, and PTO is not connected.	Connect the PTO or restart the system from the ignition.

### 8.8.3. Display

The display has three menu items: *Error codes*, *Timers & Counters* and *VSL*. These items are shown on the screen when the display is first engaged. To be able to select an item push the menu toggle button or the OK button. In the bottom left of the screen the name of the item currently highlighted is shown.

#### Buttons

- (1) Push to go back to main menu
- (2) Push to go back one step
- (3) Push to toggle between menu items
- (4) Push to select item

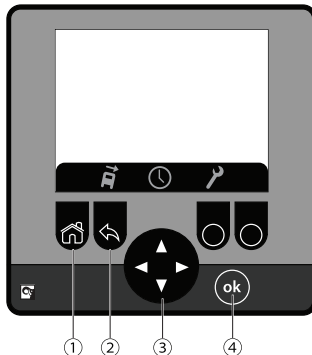

#### Menu items

##### *Error codes*

If item *Error codes* is selected and there are errors present in the system the screen will show a three-digit number for each fault in the system.



##### *Timers & Counters*

When item is selected information is shown about:

- Total time - Number of hours that the crane has been engaged
- Use time – Number of hours that dump valve has been active
- Lift count – Number of lifts made
- Time to service – Number of hours with the crane engaged until next service
- Use time to next service – Number of hours with dump valve active until next service
- Lifts to service – Number of lifts until next service

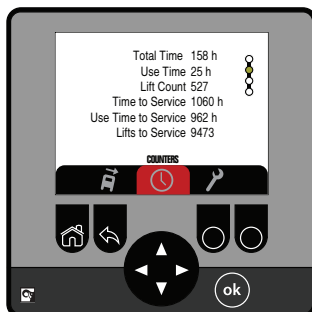



## VSL

If you select this symbol, the truck VSL diagram shows six sectors surrounding the crane, and in each sector there is a percentage. A percentage of 90 indicates that the maximum pressure available in the 1st boom cylinder is reduced to 90% in this sector to guarantee full stability. The different sectors are marked with colors: green, yellow, grey or red. The green indicates the highest percentage of the maximum pressure and red indicates the lowest percentage.

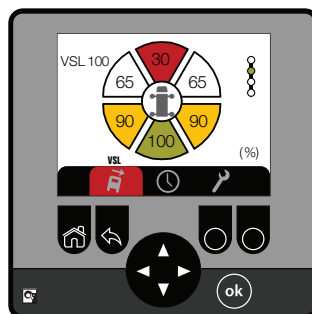

### NOTE

The percentages refer to the maximum pressure available in each sector in the 1st boom cylinder, not the percentage of the maximum net load shown the load plate.



### NOTE

Always refer to the stability diagram and the lifting capacity diagram delivered by the installer to know which are the lifting capacities and lifting loads that your crane has depending on the stabiliser legs and crane position.

## Feature indication

If feature LSS-V is activated the screen turns green and a symbol of a hook is shown. This to notify the operator of the occurrence. When the screen goes back to normal the symbol of the hook is shown in the top right of the screen. When deactivating LSS-V the screen turns red and the hook symbol is shown, this time crossed. The hook symbol in the top right of the screen disappears.

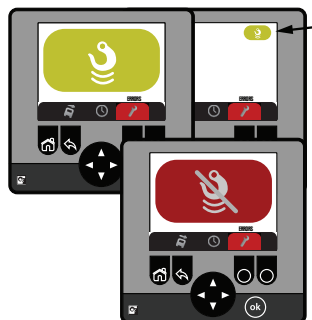

## 8.8.4. Gateway connection box [option]

### POWER LED (1)

The LED is steady green = the gateway has power.  
 The LED is off = the gateway has no power.  
 The LED is steady red = the gateway is in standby mode.  
 The LED shows a red blinking light = the gateway is shutting down.

### STATUS LED (2)

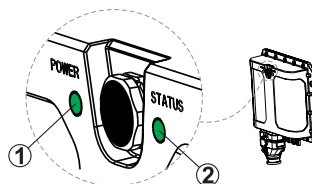

The LED is steady green = the gateway is operational and all connections are correct.





The LED shows a green blinking light = there is an error in the connection.

The LED is off = the gateway is off.

## ERRORS

The STATUS LED (2) shows the status of the connection between the gateway, SPACE, GPS, and 3G/4G.

You can read different error codes from the STATUS LED on the gateway. If two or more errors exist in the system, the blinking sequence will show them in the same sequence.

Error code number	Blinking sequence	Problem	Possible cause
1	1 blink 	The gateway is not able to read the product data (this state is not in use in the factory image).	<ul style="list-style-type: none"> <li>SPACE is not on.</li> <li>The cable between SPACE and the gateway is not connected correctly.</li> <li>The gateway is not configured correctly. Contact Effer support.</li> </ul>
2	2 blinks 	The gateway is not able to connect to the Cargotec cloud.	<ul style="list-style-type: none"> <li>Poor 3G/4G coverage.</li> <li>The antenna is not connected correctly or it is damaged.</li> <li>The gateway is not configured correctly. Contact Effer support.</li> </ul>
3	3 blinks 	The gateway is not able to read the correct GPS location.	<ul style="list-style-type: none"> <li>The antenna is not connected correctly.</li> <li>Poor GPS signal strength.</li> </ul>
5	5 blinks 	The gateway is not operational yet.	<ul style="list-style-type: none"> <li>Software is updating.</li> </ul>



## NOTE

If the system stops while the software is updating, the update will be put on hold until the system starts again.

**Example:** Several errors exist in the system.

Error 2 and 3 exist in the system.



#### NOTE

If error 1, 2, and 3 exist in the same time, do a check that you have the correct Gateway kit (**EU** for European Union or **US** for United States, Canada and Mexico).

## 9. Decommissioning

### 9.1. Decommissioning a crane



#### NOTE

Only qualified companies can remove the crane from the truck and dispose of it.

Cranes are designed and manufactured taking the environment into consideration. Environmental requirements and soundness have been considered when selecting the raw materials. The metal parts are designed to achieve a light and durable construction; this includes the selection of higher-quality grades of steel. When the crane is decommissioned at the end of its service life, years from now, waste will be created, which must be utilised and disposed of correctly. The crane must be decommissioned properly. Most of the crane's raw materials can be recycled.

#### Follow the regulations of the local authorities!

- Oil and grease must not be spilled on to the ground or released into the environment!
- Drain the oil from hydraulic cylinders, valves and hoses.

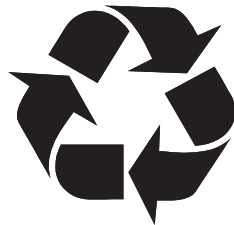

#### Sort the waste

- Deliver the metal parts for recycling, for reuse as raw material. These are load-bearing, structures manufactured from steel or cast iron, hydraulic cylinders and lines drained of oil, directional control valves, shafts, bearing bushes, control levers, small parts.

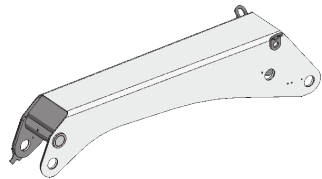

**Energy waste** can be utilised by incinerating it at a proper waste incineration plant.

- Spiral wraps, manufactured from polyethylene, plastic, bearings (cleaned of lubricants) used in the column, beam system etc, manufactured from polyamide plastic.

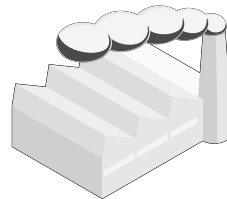

**Unsorted waste** should be delivered to a landfill.

- Drained hydraulic hoses, electrical wires, control cables, seat, hydraulic cylinder seals, lights, small plastic and rubber parts.



**Hazardous waste** is delivered to a collection point for hazardous waste.

- Oils: hydraulic oil, transmission oil from the slewing system
- Solid lubricants: greases from the joints and journal bearings
- Other waste containing oils and greases: hydraulic oil filters.



#### European Union—Disposal Information

This symbol identifies the parts of your crane that need to be disposed of separately from household waste according to EU legislation. When one of these parts reaches the end of its life, take it to a collection site designated by local authorities. Responsible collection and recycling help protect natural resources, the environment, and human health.

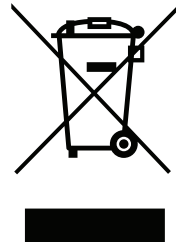

## 10. Technical Data

### 10.1. Load plate table

The Installer must fill in the valid meters (**m**) and kilos (**kg**) in this table, following instructions given in the Installation instructions.

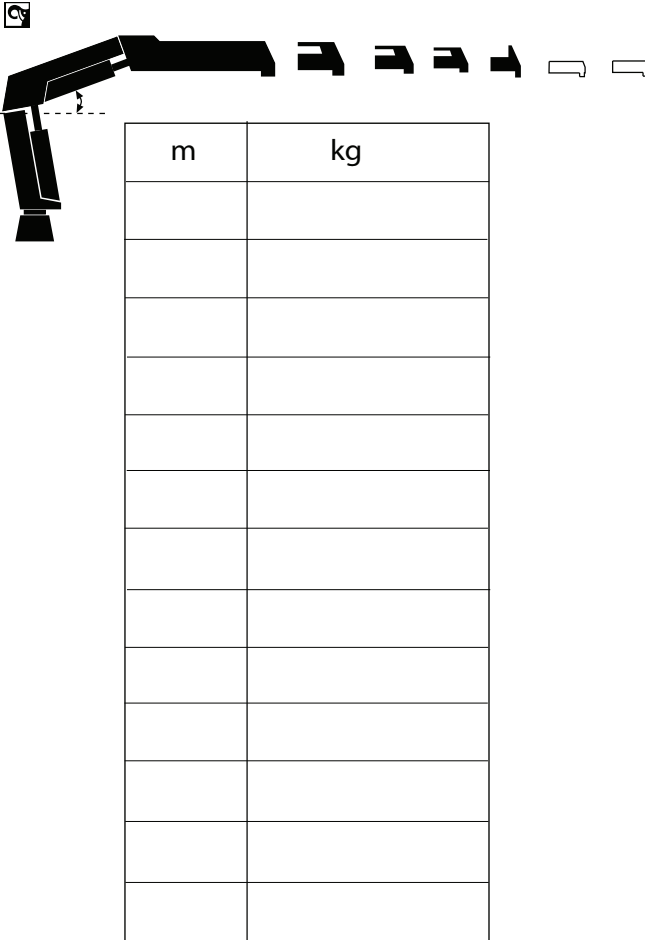

The diagram shows a crane arm with a hook and various attachments. A dashed line indicates the height of the hook. Below the diagram is a table with two columns: 'm' (meters) and 'kg' (kilos). The table has 13 rows, with the first row containing the column headers.

m	kg

The enclosed Technical Data must be stored together with this Operator's manual.

## 10.2. Identification of the loader crane

The information below is to be filled in by the installer. The same information will be found on the serial number plate on the crane:

Mark: EFFER

Type: .....

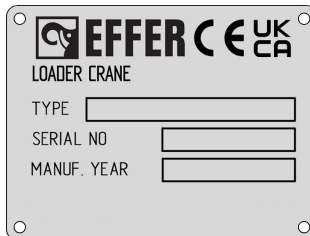

Serial number: .....

Manufact. year: .....





EFFER CE UK CA  
 LOADER CRANE  
 TYPE   
 SERIAL NO   
 MANUF. YEAR

## 10.3. Daily inspection checklist

Operator			Document ID:	
Crane s/n:			Date:	
DAILY INSPECTION				Comments
Presence of signs and symbols				
Locking devices				
Spirit level				
Shafts, locking shafts, bearings and bushings				
Crane structure				
Hooks				
Lifting accessories, interchangeable equipment and optional crane components				
Electronic components				
Security seal wires				
Hydraulic system and oil level in the tank				
Oil level in the slewing housing and condition				
Oil level in the slewing motors and condition				
Filters				
<b>FUNCTIONAL TESTS</b>				
Emergency stop buttons				
Levers				
Controller				
Horn and LED test				
<p>If you find a fault that prevents you from operating the crane safely, contact an authorised service workshop. Do not try to repair the fault, it can cause you injury or you can damage the equipment.</p> <p>Permission to reproduce this checklist is granted; however please note that only the original document owned by Hiab will contain necessary amendments and updates. Hiab shall not be held liable if the copy in your possession does not contain the latest changes.</p>				



## 10.4. Monthly inspection checklist

Operator			Document ID:	
Crane s/n:			Date:	
MONTHLY INSPECTION				Comments
Piston rods				
Pivot pins and bushes				
Bolts and screw fixings				
Cables and sensors				
Lubrication schedule				
Slewing bearing / Upper column bearing				
Pump attachment screws				
Gateway connectivity				

If you find a fault that prevents you from operating the crane safely, contact an authorised service workshop. Do not try to repair the fault, it can cause you injury or you can damage the equipment.

Permission to reproduce this checklist is granted; however please note that only the original document owned by Hiab will contain necessary amendments and updates. Hiab shall not be held liable if the copy in your possession does not contain the latest changes.

---

This page is intentionally left blank.



© EFFER

All rights reserved.

No part of this publication may be reproduced or copied in any form or by any means without written permission from EFFER.

EFFER is part of Cargotec Corporation.

