

EFFER 65D-80D-105D X4



Operator's Manual GB

737 3179



Congratulations!

You are now the owner of a quality Product manufactured by Hiab (part of Cargotec Corporation).

The aim of this manual is to help you handle, maintain your crane safely and with full satisfaction.

This Manual provides detailed information about your Product, its control systems and its practical management and maintenance.

Please read the complete Manual carefully and make sure that you understand its contents. Please also carefully familiarise yourself with your Product before you start to use it.



Help us to improve this manual. Please send your comments and suggestions to **documentation@hiab.com**

This operator's manual is an Original Instruction and applies to cranes with serial number from:

BE065D00001, BE080D00001, BE105D00001.

2022-12

This page is intentionally left blank.

Table of Contents

1. Introduction	9
1.1. Target group and scope of this manual	9
1.2. Indications in the Operator's Manual	10
1.3. Cleanliness certificate	13
2. Structure and parts of the crane	14
2.1. Main groups	14
2.2. Crane base with column and slewing system	15
2.3. Stabiliser system	15
2.4. Boom system	16
2.5. Operating system - hydraulic components	18
2.6. LHV Load holding valves	19
2.7. Description of the crane	19
3. Safety precautions and warnings	20
3.1. Operating conditions	20
3.2. Wind speed	21
3.3. Definition of this loader crane	22
3.3.1. Determination - Hoist	23
3.3.2. Noise declaration	23
3.3.3. Signs on the crane	24
3.3.4. Maximum load	24
3.3.5. Maximum load moment	26
3.3.6. Lifting loads with hoist	28
3.4. Signals when using a crane	29
3.5. Use of the crane	32
3.5.1. Preparations for use	34
3.5.2. Crane operation	35
3.5.3. Driving with the crane	39
3.5.4. Use of the Hoist	39
3.5.5. Use of lifting accessories and interchangeable equipment	41
3.5.6. Use of demountable cranes	42
3.5.7. Ending crane operation	42
4. The control system	43
4.1. Control System SPACE X4	43
4.2. How the safety system works	43
4.3. Components of the control system	44
4.4. Standard symbols and functions of the crane and the stabiliser system	45
4.5. Main control valve	46
4.6. Different stabiliser control valves	47
4.7. User panel	48
4.7.1. Indicator LEDs on User Interface	48
4.8. Lamp pole [option]	51
4.9. XSDrive controller	51
4.9.1. Indicator LEDs on XSDrive controller	51
4.9.2. Buttons	53
4.9.3. Menus	54
4.9.4. Standard function symbols	55
4.9.5. Battery and battery charger XSDrive	55

4.10. Pressure-reducer filter	56
4.11. Control platform [option]	57
5. Starting crane operation	58
5.1. Starting operations	58
5.2. Set the stabiliser system	60
5.2.1. Activate the stabiliser system	62
5.2.2. Extend the stabiliser extensions	62
5.2.3. Set the stabiliser legs	63
5.3. Operate the boom system out of transport position	66
5.3.1. BDA Boom Deployment Assistance [option]	68
5.3.2. Operate the boom system	69
5.3.3. SAF Semi Automatic Folding [option]	69
6. During operation	72
6.1. Features	72
6.1.1. Controlling the crane speed with the controller XSDrive	72
6.1.2. Supervision of spools	72
6.1.3. OPS Operator Protection System [option]	72
6.1.4. APO Automatic power off	72
6.1.5. ADO Automatic Dumping of Oil	73
6.1.6. ASC Automatic Speed Control	73
6.1.7. Slewing sector [option]	73
6.1.8. VSL Variable Stability Logic [option]	74
6.1.9. LSS-V Load stabilising system-vertical [Option]	77
6.2. OLP (Overload protection)	77
6.3. OLP - indications on the controller	78
6.4. To release OLP	78
6.5. Manual extensions [option]	79
6.6. How to change from hoist to hook operation	82
7. Ending crane operation	86
7.1. Before folding a boom system with a hoist	86
7.2. SAF Semi Automatic Folding [option]	87
7.3. Operate the boom system into transport position	89
7.3.1. Operate the boom system	90
7.4. Placing the stabiliser system in the transport position	91
7.4.1. Retract the stabiliser extensions	93
7.5. Switching off the control system	94
7.6. Emergency operation Valve-V80	95
7.7. Transport warning [option]	97
8. Maintenance and Service	98
8.1. Service	98
8.2. Warranty	99
8.3. Follow the maintenance instructions!	99
8.3.1. Daily inspection	101
8.3.2. Monthly inspection and maintenance	105
8.3.3. Annual maintenance	106
8.3.4. Hoist maintenance plan	107
8.3.5. Check rope	108
8.3.6. Clean the hoist rope	109
8.3.7. Course and requirements of the rope	109
8.3.8. Change of rope	110

8.3.9. Maintenance and monitoring of rope end	113
8.4. Lubrication	113
8.4.1. Lubrication schedule	115
8.4.2. Greasing the upper column bearing and three-point bridge	116
8.4.3. Lubrication of the column bearings	116
8.4.4. Lubrication of the hooks	117
8.4.5. Lubrication of intermediate pulleys, rope guides and top roller	118
8.5. Checking and topping up oil levels	118
8.5.1. Slewing housing: checking the oil level and topping up	118
8.5.2. Checking of the oil level of the tank	119
8.5.3. Oil level checking	122
8.5.4. Oil filling, top up and replacement procedures	122
8.6. Replacement of filters	124
8.7. Bleeding air from the hydraulic system	125
8.8. Troubleshooting	126
8.8.1. Main fuses	126
8.8.2. Faults on the crane	126
8.8.3. Faults in the hoist	130
8.8.4. Display [option]	131
8.8.5. Error codes	132
8.8.6. Gateway connection box [option]	134
9. Decommissioning	136
9.1. Decommissioning a crane	136
10. Technical Data	138
10.1. Load plate table	138
10.2. Documentation	138
10.3. Identification of the loader crane	139
10.4. Theoretical using time Hoist	139
10.5. Performance Data TC1, rope capacity	140
10.6. Performance Data T11, rope capacity	140
10.7. Abbreviations	141
10.8. Daily inspection checklist	142
10.9. Monthly inspection checklist	143

This page is intentionally left blank.

1. Introduction

1.1. Target group and scope of this manual

This manual describes:

- Operation
- Safety precautions and warnings
- The crane control system
- Maintenance and troubleshooting

Enclosed to this manual the Installer will provide:

- Technical Data for your crane
- Technical Data and manuals for interchangeable equipment if fitted

Study these instructions carefully and keep them



DANGER

If you do not study the complete Operator's Manual for your crane carefully, it could lead to fatal accidents or serious damage.



NOTE

Keep these instructions for future reference.

Therefore you should:

- Study the entire Operator's Manual carefully.
- Study the operating manuals for other interchangeable equipment and/or optional crane component, if fitted.
- Use the crane only after having done so.
- Follow the directions for use, operation and maintenance of the crane, interchangeable equipment and/or optional crane component exactly.
- Store the Technical Data and manuals from the Installer, together with this Operator's manual.



**NOTE**

Hiab, or a third party designated by Hiab, shall at all times have the right to (i) install, maintain and dismantle a remote diagnostics device in and from the Products; and (ii) access, send, receive, collect, store, copy, aggregate, combine with other information, process, make available, further develop and use any and all information and data gathered through the remote diagnostics device, including but not limited to, information concerning equipment identity, efficiency, availability, downtime, operation, operating environment, movement, condition, logon, location and similar information relating to the Products (the **“Information”**). Such Information may be used for providing, delivering, optimizing, developing, servicing and offering the Products or any related products, equipment, and services. The Information may also be used for example for sales and marketing, Hiab's internal business and/or operating purposes as well as for regulatory, warranty and contract compliance and for proactive maintenance and diagnostics. The Information may be shared to Hiab's group companies and to Hiab's and its group companies' dealers, subcontractors, service providers and other business partners for the above described purposes.

The Customer shall not in any way remove, disable, or interfere with the remote diagnostics device or the Information without Hiab's prior written consent. Any intellectual property rights or other right and title in and to the remote diagnostics device and its features and the Information and all their further developments shall at all times be and remain the exclusive property of Hiab.

1.2. Indications in the Operator's Manual

What must you do and not do?

The following indications are used in the Operator's Manual:

**DANGER**

Danger to life for yourself or to bystanders.

Follow the instructions carefully!

**WARNING**

Danger of injury to yourself or to bystanders, or danger of serious damage to the crane or other objects.

Follow the instructions carefully.

**CAUTION**

Hazard for the crane or crane components. Follow the instructions carefully.

Important:

If actions are numbered, do them in numerical order!

1. Do this
2. Do that
3.

**NOTE**

Extra information that can prevent problems.

**TIP**

Tip to make the work easier to carry out.

The symbol for reference to a component in an illustration.

(1) Refers to a component in an illustration.

[option]: Indication for parts that are not standard for the crane, but are optional. Not all options are available for your crane.

Illustrations used in this manual are for guidance only, and the illustrations are provided to help identify the general area of a crane/installation referenced in the text.

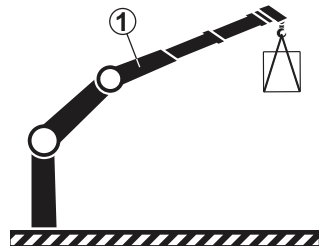
**DANGER**

Only persons with the requisite knowledge and experience with cranes may use the crane. Never operate the crane when you are sick, tired, under the influence of medicines, alcohol, or other drugs.

- Take the delivery instructions from your authorised service workshop, or receive instruction from an experienced person from your own company before you start to operate your crane.
- Make sure that you comply with the regulations of the country in which you use the crane (for example, certificate, safety helmet, and other personal protection devices).



DANGER

- Carry out yourself only the service and maintenance work you have the requisite knowledge and experience of.
- All other maintenance work may only be carried out by an authorised service workshop.
- Make sure that every defect is rectified immediately, according to the instructions.
- Follow the instructions exactly!
- Do not adjust/replace safety hydraulic/electrical components on the crane, as you can cause dangerous accidents. Only an authorised service workshop can do these actions.
- All other work to rectify faults must be performed by personnel in an authorised service workshop!

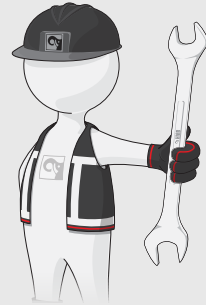

WARNING

- Never clean the electronic system, plastic components, signs, or bearings with a high-pressure jet cleaner. It could cause damage.
- Never expose the electronic system to high electrical voltages. This could damage the control system.
- Never immerse the controller in water or other liquid. This will make the controller unusable.

If your crane is equipped with interchangeable equipment and/or optional crane components (JIB, hoist, rotator, etc.):

- The operation of the crane with interchangeable equipment and/or optional crane components can differ from the operation as described in this manual.
- You should therefore study the Operating Manual for the interchangeable equipment and/or optional crane components carefully before you use the crane.
- Take particular note when placing the crane into or out of the transport position.

1.3. Cleanliness certificate

All Hiab equipment has been tested and certified at the factory according to the Hiab Standard C250.52 that defines the Cleanliness Requirements for Hydraulic Systems. This means that they fulfil the cleanliness class **20/18/14** measured by the ISO 4406 standard.

All hydraulic functions have been individually tested and fully comply with the defined requirements.



2. Structure and parts of the crane

2.1. Main groups

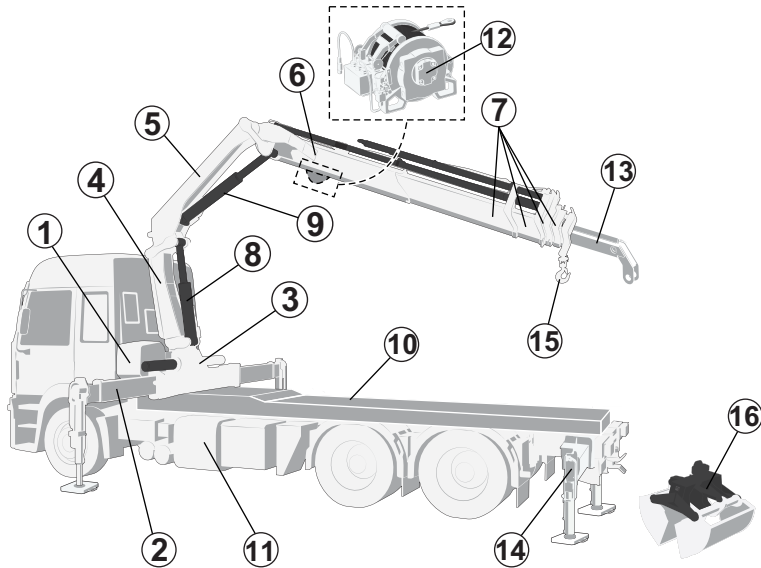

This crane consists of the following main groups:

- | | | |
|-------------------------------|-----------------------|---|
| (1) Control station | (6) 2nd boom | (11) Oil tank |
| (2) Stabiliser system | (7) Boom extensions | (12) Hoist [option] |
| (3) Base / Three-point bridge | (8) 1st boom cylinder | (13) Manual extensions [option] |
| (4) Column | (9) 2nd boom cylinder | (14) Auxiliary stabilisers (incl. front) [option] |
| (5) 1st boom | (10) Subframe | |

Interchangeable equipment (e.g. grapple, clamshell bucket, pallet clamp, etc.), intended to be used on loader cranes can be attached depending on your crane configuration. Please refer to the operator's manual for the equipment.

- (15) Hooks [option]
- (16) Grapple [option]

2.2. Crane base with column and slewing system

The crane base, column and the slewing system consist of the following components:

- (1) Crane base
- (2) Stabiliser beam
- (3) Three-point bridge
- (4) Column
- (5) Rack and pinion slewing system.

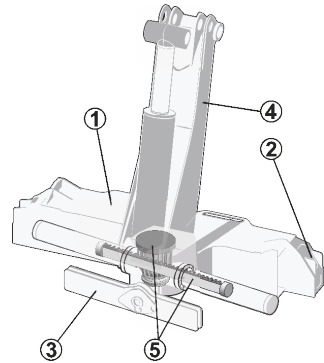

2.3. Stabiliser system

EFFER cranes (except stationary mounted) have two stabiliser extensions and two stabiliser legs. Auxiliary stabiliser systems may be needed for bigger cranes. The stabiliser system consists of:

- (1) Stabiliser beam
- (2) Stabiliser extensions
- (3) Stabiliser legs
- (4) Stabiliser locking devices [option]
- (5) Extra support plates

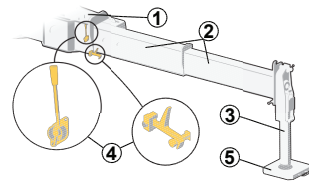

2.4. Boom system

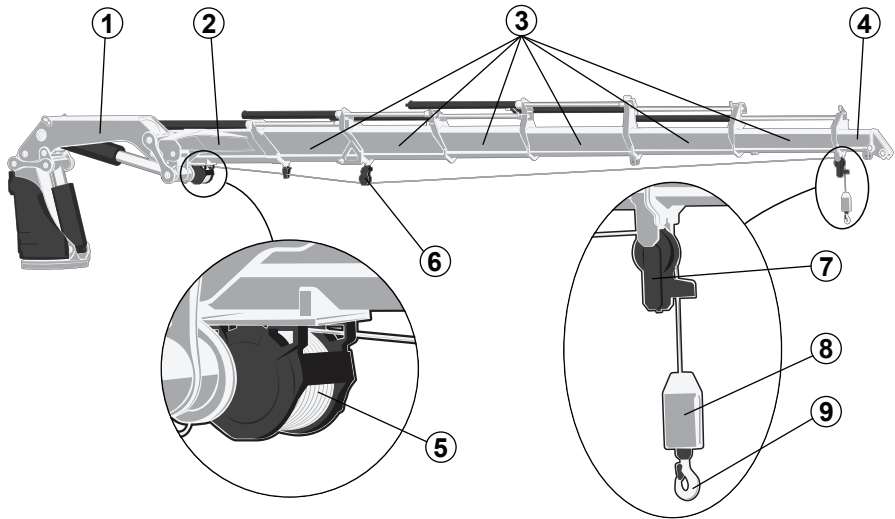

The boom system consists of the following main parts:

- (1) 1st boom
- (2) 2nd boom
- (3) Hydraulic extensions
The length of the hydraulic extension depends on the type of crane.
- (4) Manual extensions [option]
- (5) Hoist [option]

And optional interchangeable equipment such as:

- (6) Rope guide [option]
Only present if the crane is equipped with a minimum of 3 hydraulic extensions.
- (7) Top roller [option]
The top roller must only be attached to a hydraulic extension, never to a manual extension.
- (8) Counterweight [option]
- (9) Hook [option]
- Pallet fork, Grapple, Rotator, etc... [option]

Manual extensions [option]

The manual extension is slid by hand into the hydraulic extension.

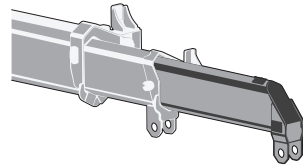

Hoist [option]

The hoist is an optional crane component which permits load handling without any or only limited boom movement. An obvious advantage is that the hoist makes it possible to handle loads far below ground level.

Lifting and lowering is achieved by winding/unwinding the rope. A number of auxiliary components are needed, such as intermediate pulleys and a hook pulley. As an option, a snatch block can be installed to multiply the lifting capacity.

The Hoist consists of the following components:

- (1) Pressure roller
- (2) Wear pad (for rope-end-monitoring)
- (3) Rope
- (4) Load sensor
- (5) Cable (to load sensor)
- (6) Electronic box
- (7) Switch (for rope-end-monitoring)
- (8) Motor

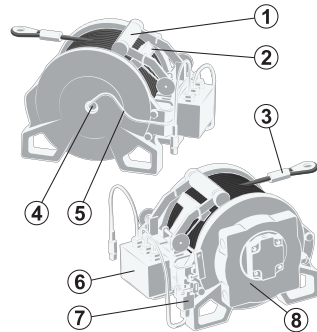

Hooks [option]

Different hooks can be mounted depending on the crane model.



DANGER

Never exceed the maximum permissible loading of the hook.

Lifting accessories [option]

Equipment placed between the holding device of lifting machinery and the load is considered as a lifting accessory.



2.5. Operating system - hydraulic components

The operating system consists of the following hydraulic components:

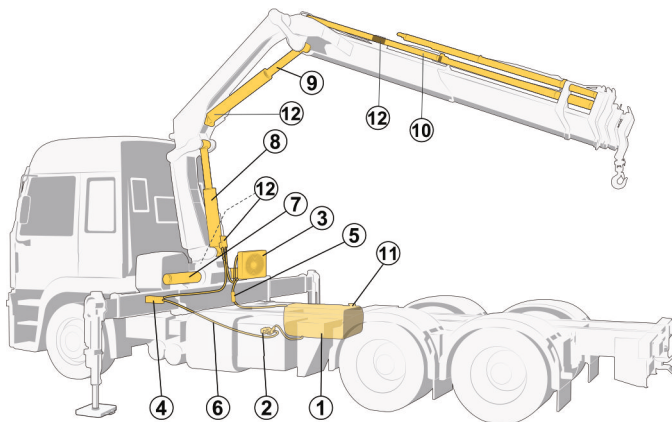

(1) Oil tank	(5) Stabiliser control valve [option]	(11) Return filter
(2) Hydraulic pump	(6) Hydraulic hoses and lines	(12) Load holding valve
(3) Oil cooler [option]	(7) Slewing cylinders / Slewing motors	Pressure filter [option]
(4) Main control valve	Actuators: (8) 1st boom cylinder (9) 2nd boom cylinder (10) Extension cylinder/s	

2.6. LHV Load holding valves

All cylinders are equipped with load-holding valves as a safety device. After a crane movement, they hold the crane in position, also in the unlikely event of a burst hose.

If there is a leak or a component fractures, such as a pipe, hose or coupling, the load-holding valves will stop the booms from collapsing down, even when the hydraulic system is switched off, and you operate a particular crane lever.

To operate a hydraulic cylinder equipped with a load holding valve, an opening pressure is required.

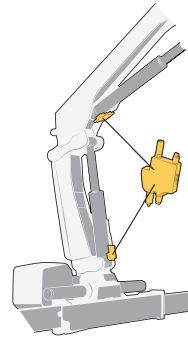

DANGER

It is not permitted to manipulate these devices because you can cause serious accidents.

Only an authorised service workshop can do the servicing, replacement and/or repair of these valves.

2.7. Description of the crane

The EFFER	Stress history class according to EN 13001-1
65D	S1
80D	S2
105D	S2

are hydraulic powered loader cranes.

Loader cranes without the CE or UKCA marking have been designed and calculated according to the standard EN13001.

The crane type and the manufacturer are marked on the manufacturer plate.

The hoist **[option]** is designed for an EFFER crane, installed on the 2nd boom.



NOTE

The exact technical information for your crane is shown in the Technical Data.

3. Safety precautions and warnings

3.1. Operating conditions

You may use the crane **ONLY** if:

- You are outdoors or in a space with sufficient ventilation.
- With a mean wind velocity of less than 13.3 m/sec (approx. 29.7 mph). **Refer to the wind speed table.**



DANGER

- **Do not use** the crane in a confined space because you could suffocate from the exhaust gases from the vehicle.
- **Never** use the crane in a high wind or storm. When the mean wind velocity exceeds 13.3 m/sec (approx. 29.7 mph) the crane will behave unpredictably. **Never** use the crane during a thunderstorm.
- **Never** use the crane at temperatures below -30°C (-22°F), as the steel's properties deteriorate below this temperature.



WARNING

- At temperatures below 0°C (32°F), do not touch the operating levers during the first few minutes.
- In cold weather, the wear on the hydraulic system is greater than at normal working temperatures.

In cold weather, start the crane as follows:

- Engage the power take-off at low rpm.
- Allow the system to idle for a few minutes.
- Operate stabiliser legs up and down for one minute, in order to warm up the oil.



3.2. Wind speed

Refer to the table below to correctly identify the wind speed.

Wind speed averaged over 10 minutes at a height of 10 m

Wind Force	Above flat ground		Characteristics
	m/s	Wind type	
0	0.0 - 0.2	Calm	Calm, smoke rises vertically or nearly vertically
1	0.3 - 1.5	Slight breeze	Wind direction recognisable from smoke plumes, the wind begins to be noticeable on the face; leaves begin to rustle and weather vanes can start to move.
2	1.6 - 3.3		
3	3.4 - 5.4	Moderate wind	Leaves and twigs in continuous movement, small branches begin to move. Dust and paper begin to move over the ground.
4	5.5 - 7.9		
5	8.0 - 10.7	Fairly strong wind	Small leaved branches make swaying movements; crested waves form on lakes and canals.
6	10.8 - 13.8	Strong wind	Large branches move; you can hear the wind whistling in telephone wires; umbrellas can only be held with difficulty.
7	13.9 - 17.1	Severe wind	Entire trees move; the wind causes difficulty when you walk into it.
8	17.2 - 20.7	Stormy wind	Twigs break off, walking is difficult.
9	20.8 - 24.4	Storm	Causes superficial damage to buildings (chimney pots, roof-tiles, and TV antennae are blown off).
10	24.5 - 28.4	Severe storm	Uprooted trees; considerable damage to buildings etc. (occurs infrequently on land).
11	28.5 - 32.6	Very severe storm	Causes extensive damage (occurs very infrequently on land).
12	> 32.6	Hurricane	



NOTE

Conversion to different measurements units:

- 1 m/s = 3.6 km/h
- 1 m/s = 2.24 mph

3.3. Definition of this loader crane

Usage of the crane

The EFFER loader crane is used to lift and move loads in the working area permitted by the load plate and the load diagram. The cranes are normally mounted on a vehicle but they can also be mounted on a fixed base plate. The crane can be equipped with a number of lifting accessories/interchangeable equipment.

Permitted/forbidden use of the loader crane

Permitted duties:

- Loading and unloading cargo from/on vehicles
- Lifting and moving loads from vehicles
- Handling loads with lifting accessories/interchangeable equipment* intended to be used on loader cranes.

*As specified in the documents for the equipment.

Forbidden duties (unless the loader crane is specially prepared for a certain duty following authorisation from Hiab):

- Installing the crane on ships or floating structures
- Continuously using the crane as a production crane in assembly lines, foundries...
- Handling loads, working with submerged boom systems or accessories, in strong currents such as rivers
- Applying pressure downwards
- Pushing/pulling with the boom system against any type of obstacle (wall, ground...)
- Transferring loads of unknown weight to the crane
- Using the JIB upside down (please always refer to the Operator's Manual for your JIB to see what is allowed)
- Putting loads on structures if you do not know their resistance
- Lifting a mass that is partially loaded or attached to another equipment/structure/element

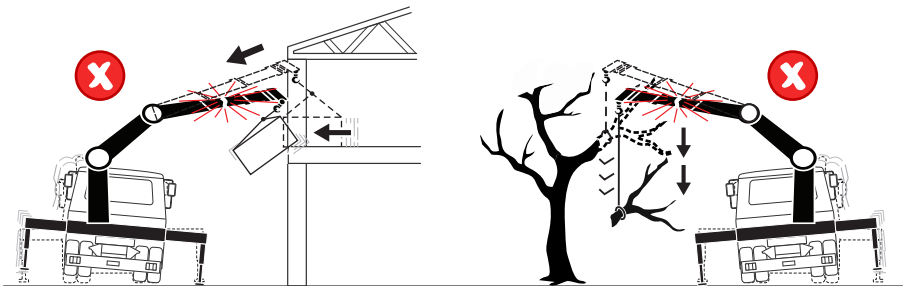

CAUTION

There is a risk of tipping the truck and/or damaging the crane, the load or other structures inside the working area.

- Lifting people

- Using a personnel basket (as the crane must be certified as a MEWP crane by a notified body). Please always refer to the MEWP's Operator's Manual.

**DANGER**

Lifting people with a crane is never allowed unless it is a MEWP crane. When working in a personnel basket, both feet must have contact with the floor of the basket. Standing on boxes or ladders in the basket can lead to injury or death.

3.3.1. Determination - Hoist

The TC/TI hoists belong to the group of hoisting winches. The use as determined is hoisting and lowering of loads as specified for each hoist type and under the attention of the given installation regulations as well as of the safety notes.

**DANGER**

Transportation of passengers with the hoist is not permitted.

The use as determined also includes the related equipment manufacturer's recommendations regarding installation, operation and maintenance.

Machine safety is guaranteed only if it is used for its intended purpose and according to instructions in this manual.

3.3.2. Noise declaration

The following values for emitted noise may be taken as general and conservative values for ordinary installations of loader cranes on normal diesel engine powered trucks. Declared dual-number noise emission values in accordance with ISO 4871:

- Emitted A-weighted sound power level for basic loader cranes in accordance with ISO 3744: LwA = 103 dB (Uncertainty: KwA = 2 dB).
- Emitted A-weighted sound power level for loader cranes with hoist in accordance with ISO 3744: LwA = 107 dB (Uncertainty: KwA = 2 dB).
- A-weighted sound pressure level at loader crane control stations in accordance with ISO 11201: LpA = 95 dB (Uncertainty: KpA = 4 dB).



NOTE

When you use equipment such as hoist, JIB, lifting accessories or interchangeable equipment and their necessary components, you add weight to the load. Because of this, the load you can lift is less heavy.

Load plate

On the plate is the maximum weight that you may lift at a given reach, with the 1st boom in the optimum position. In chapter Technical Data in this manual you will find these values for your crane.



Optimum position

The weight that your crane can lift will be determined by:

- Stability test of your crane on vehicle [if VSL as option]
- Stabiliser extensions positioned and legs pressed to ground.
- The reach at which you are working and the optimum position of the boom.
- The optimal position for your crane is on the load plate.



DANGER

Never exceed the maximum weight on the load plate.

Load diagram

The load diagrams are placed on the column and show the maximum loads your crane / JIB (if fitted) / hoist (if fitted) may lift in the entire working zone (manual extensions excluded). The load diagram drawing will also be found in the enclosed Technical Data.

The white area is the working zone of the crane.

The load curves show the maximum load that may be lifted at a given reach and height. For a given maximum load, the possible working zone is to the left of the load curve. The lifting capacity for some cranes is limited in the high lifting area.

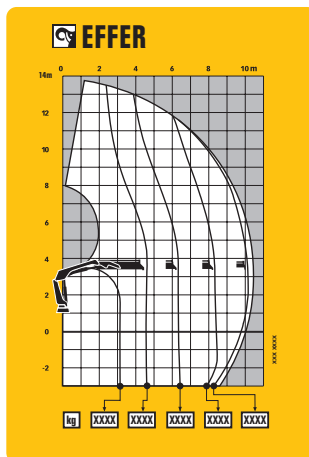

Hoist capacity

When hoisting, the capacity is adjusted for some crane models. To operate the crane safely, you must always read and understand the values on the load plates/diagram for the hoist.

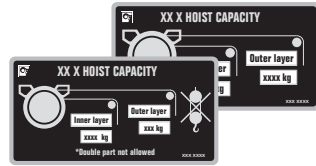

WARNING

Care must be taken when handling loads in the high lifting area, so the load/tool does not come into contact with the boom system.



WARNING

Never operate the hydraulic extensions against a solid object when the first boom is completely lifted. Do not try to push or compress loads when the first boom is fully lifted, as this could cause damage to the first boom cylinder.

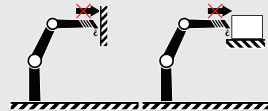

3.3.5. Maximum load moment

If your crane has reached the maximum load moment (lifting capacity), the OLP gives a warning and locks any crane movement that will increase the load moment. This is known as an OLP situation.

If the 2nd boom is raised, the following movements are locked:

- 1st boom down/up
- 2nd boom down
- extension boom out

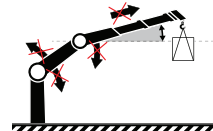

If the 2nd boom is down, the following movements are locked:

- 1st boom up
- 2nd boom up
- extension boom out
- 1st boom down (certain crane types and cases)

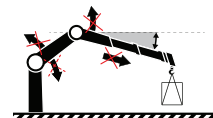

Lifting the load

Make sure that you always have a clear view of the load. If you do not see the load, you can cause injury to people or serious damage to the surroundings.

Sling length

Always attach the load using the shortest possible sling.

The angle between the legs of the sling must not be more than 120°.

The maximum working load (or Working Load Limit - WLL) of a multi-legged sling for general purposes is calculated by multiplying the WLL of a single leg by a mode factor (refer to the table).

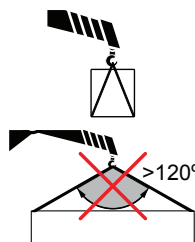

Max angle to the vertical of any sling leg (degrees)	Mode factor two-legged sling	Mode factor three- and four-legged sling
0-45	1.4	2.1
45-60	1.0	1.5

If the angle between the legs of the sling is more than 90°, do not hang the slings directly on the hook. Use a ring hanging from the hook to attach the sling.

Working close to the load

Put the vehicle as close as possible to the load.

Always try to lift the load with the extension boom retracted, but not completely. In this condition, the crane has the greatest lifting capacity.

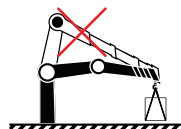

Working below ground level

If you have to load or unload below the level of the ground, keep the 1st boom angle to about 10 to 30° above the horizontal plane.



Heavy loads

Lift heavy loads with the 2nd boom in the optimum position in relation to the 1st boom. For this, see the load plate on your crane.

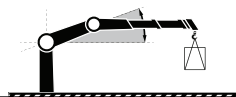



DANGER

Never exceed the maximum permissible loading of the hook.

Heavy loads cannot be handled with the boom straight.

Operate the 2nd boom to get an angle in relation to the 1st boom.

Loads at the extreme limit of the working area

When you lift the load with the 1st boom, make sure that you have at least a small angle with the 2nd boom.

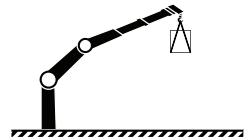

TIP

Operate the crane with various functions simultaneously to make smooth crane movements. In this way, you will also prevent the hydraulic system from heating up quickly.

3.3.6. Lifting loads with hoist



DANGER

- Use only Hiab original ropes or a rope that meets Hiab's specifications.
- Check and clean hoist rope regularly but not using high pressure fluid jets neither steam jets.
- Replace the rope if it is damaged.
- Always use safety gloves when handling ropes or slings.
- Never guide a moving rope with your hands!



WARNING

- Make sure that ropes do not touch or slide over corners, cutting edges or other obstacles.

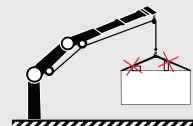



WARNING

- Rope connections, bushings, press heads, short splices, etc. must not be run through the top roller.

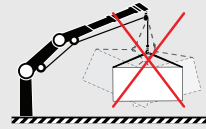

3.4. Signals when using a crane



DANGER

- If it is not possible to see the load and the entire working area clearly, the crane operator must follow the instructions and signals given by a qualified person.
- The country-specific regulations for crane operator signals are to be used.

Signals in this manual give a number of standard signals that can be used.

Lift

Raised arm and index finger raised. Circular motion with the hand.



Lower

Arm pointing downwards and index finger down. Circular motion with the hand.



Stop all crane movements / Hold the load in position

Raise the open hand, with the palm clearly visible, and arm at shoulder height.

Keep the hand still.



Emergency stop for all movements by the crane

Raise the hands and the arms to an oblique angle.



Very short movement

Place the hands a very short distance apart, with the palms facing each other. The hands may be held either horizontally or vertically. The next movement may be: Lift, lower, move the lifting gear, change the reach, or turn.



Change the reach

Signal with your hands.

- Sideways movement outwards with both hands. Thumbs outwards.
- Sideways movement inwards with both hands. Thumbs inwards.



Turn in the direction indicated

Indicate the direction with the hands.

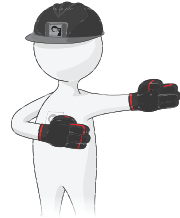

Open the tool

Extend the arms at shoulder height, with the palms facing downwards.

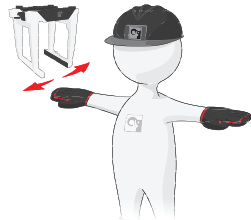

Close the tool

Move both hands close together.

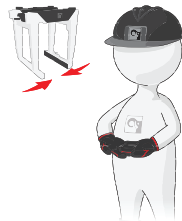

Lift the open tool a little

Extend both arms at shoulder height, with the palms facing upwards. Make vertical movements with both arms outstretched.

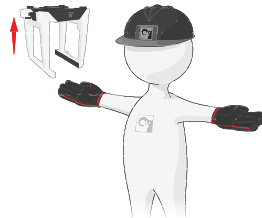

Keep the tool in position briefly

Raise the hand drooping slightly, with the fist clenched.



3.5. Use of the crane

Starting crane operation



DANGER

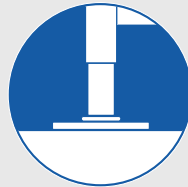

- Make sure that you comply with the regulations of the country in which you use the crane (for example, certificate, safety helmet, and other personal protection devices).
- Check that the ground is sufficiently flat and firm.
- Verify that the ground is not uneven. Be careful with sewers, cellars, excavations etc.
- To make sure that the vehicle stays in its position, always engage the parking brake and place chocks under the wheels.
- Lower the stabiliser legs only on to a flat and firm surface.
- Do not lower the stabiliser legs on the edge of an embankment, soft shoulder, slope etc.
- Make sure that you can see the stabiliser legs and stabiliser extensions when you are operating them.
- The stabiliser legs must not sink in! Use support plates that are large and firm enough for your crane. The plates must not bend because of the load weight.
- Verify that the support plates do not sink as you gradually lift the load.



DANGER

- Do not stand in front of the hydraulically operated stabiliser legs when you are operating them!
- Never use the stabiliser legs as a parking brake, since the vehicle could start to slide.
- Slide the stabiliser extension, on both sides of the vehicle, completely out if possible. Then lower the stabiliser legs for support.
- Never operate the stabiliser legs/ extensions if there is a load suspended from the crane.



WARNING

- Use low force when you put the stabiliser legs on the ground.
- Do not raise the vehicle with the stabiliser legs! If you do, you can cause damage to the stabiliser legs.
- Check that the interchangeable equipment and lifting accessories are in good condition!

Interchangeable equipment is usually attached to the boom tip (e.g. JIB, hook, grapple, rotator, etc)

Lifting accessories are connected to the standard load hook (e.g. slings, chains, shackles etc).



DANGER

Do not stand in front of the boom system when operating the crane out of transport position.

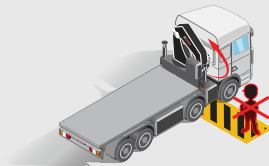

3.5.1. Preparations for use



DANGER

Make sure that there are no unauthorised persons within the operating range of your crane!

To mark the working area correctly, think about the space that the crane will need to lift the load (direction of the lift, size of the load).

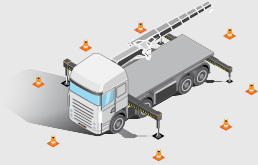

CAUTION

- Put on your vehicle's warning lights.
- Make sure that the parked truck does not block emergency exits, pedestrian roads or no-parking zones unless you have permission.
- Make sure that both the truck and the crane do not block the visibility of important signs for other users of the area (for example, road signs).



DANGER

- If a part of the crane comes in contact with an electricity line, you will be electrocuted!
- Always keep the following minimum distances between the crane and overhead electricity lines, unless otherwise prescribed by national rules.

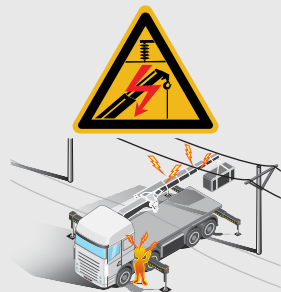

Minimum distance between crane and overhead electricity lines		
Voltage (V)	Minimum distance to an insulated conductor	Minimum distance to an uninsulated conductor
<500 V	0.5 m	2 m
500-40000 V	1.5 m	4 m
>40000 V	2.0 m	6 m
Voltages are found:		
up to 500 V:		to buildings
500-40000 V:		trams, trains
over 40000 V:		power transmission



DANGER

When you go into the control station (high-seat, cabin, platform) remove all jewellery, loose clothing, or other hanging items from your body (for example, rings, scarfs, bracelets...). Jewellery, loose clothes, and other hanging items can be caught in some parts of the crane.



DANGER

When you go into or out from the control station, use only handles and supports on the crane that were specifically made to help the operator to go into or out from the control station.



WARNING

Make sure that you know the position of all the emergency stop buttons on your crane and on the controller.

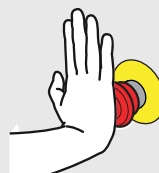

3.5.2. Crane operation



DANGER

Your crane has a control system.

The control system will help you to work safely. Nevertheless, you remain responsible for safe use of the crane!

Therefore, always work according to the operating instructions!

In an emergency situation, push immediately any of the emergency stop buttons. This will stop all crane movements and prevent the free movement of the load.



DANGER

- Keep checking that there are no unauthorised persons within the operating reach of the crane!
- Make certain that you can always see the load!

If your view of the load is not adequate, have someone else give you signals.

See the list of signals. Make certain that you and the person assisting you know these signals.

- Pay attention to the safety of the person giving the signals!
- Never move the vehicle, if you have a freely-suspended load on the crane!
- Never walk or stand under a suspended load!

During operation, never stand below the boom system or load!

- Do not slew the crane, nor lift the 1st boom, nor lift the 2nd boom into their ends positions at full speed. This can damage the crane.





WARNING

- Never push a load along the ground, or the vehicle's load space, with the extension boom. This can cause damage to the boom system. This will lead to expensive repairs.
- Never use the extension boom as a jack. This could damage the slewing bearings and the connection between the crane column and the crane base.
- Always lift the load from the ground before you start to slew. Do not tow the load over the ground. This can damage the boom system.
- If you are working with loads in restricted spaces (for example, windows):
Check that the boom system can move up and down freely.
The boom system will bend somewhat, when loading and unloading the crane.
- If the boom system is in a high position (1st boom above 70°), do not allow the boom to lower at full speed. The crane could go into an uncontrolled movement.
Be careful if, in particular, the OLP gives an early warning!
- When loading the vehicle:
Take the load off the stabiliser legs by withdrawing them slightly. The stabiliser legs must remain in light contact with the ground.

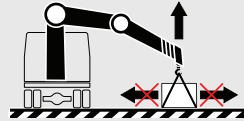
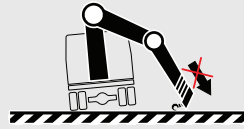

CAUTION

- Operate the crane using smooth and gentle lever movements.
- If a cylinder is at its end position, free the operating lever. Otherwise overheating can occur.

Precautions when slewing the crane

Your crane has a rack-and-pinion slewing system which provides more than 360° of rotation.

As part of the initial orientation and training:

1. Look at the plate(s) on the column to see the position of the 'slewing stop' (slewing stops).



NOTE

The exact positions for your crane can change from the image below.

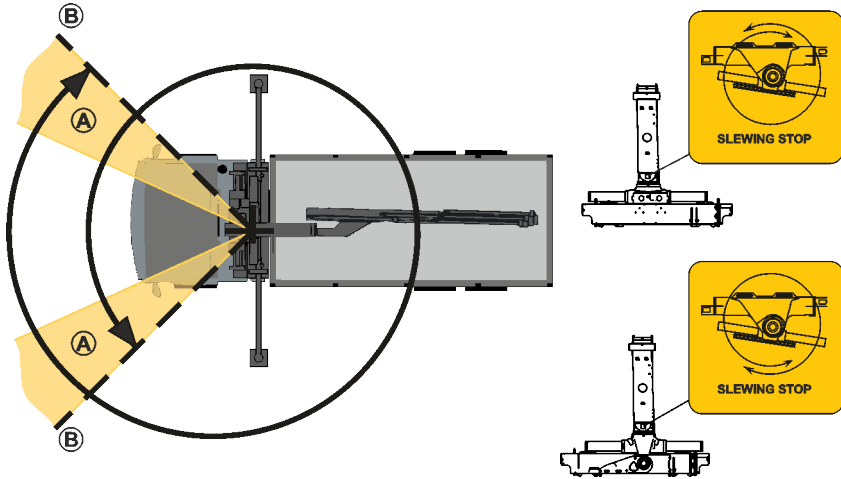

2. Slew the crane slowly in each direction to the slewing stop (B).
3. Record the slewing stop positions.



CAUTION

To prevent damage to your crane base, reduce the slewing speed in the area (A) before reaching the slewing stops (B).



NOTE

Remote controlled cranes with a slewing sensor will reduce the slewing speed automatically in the area (A), but they will not stop automatically before reaching the slewing stops (B).

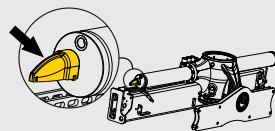

CAUTION

Repeated rotation of the crane against the slewing stops during operation can cause major crane base damage. If this operation happens, it will be considered as a misuse of the crane.

3.5.3. Driving with the crane



DANGER

- Never move/drive the vehicle if there is a load suspended from the crane.
- Before you move the vehicle:
 - Check that there is no pump flow to the main control valve. The PTO or power supply must be disengaged. The operating system must be switched off!
- Pay attention to the width and height of the crane in the transport position. The crane must stay within the width of the truck.
- Make sure the stowed crane and its equipment cannot fall, hit bridges, tunnels, other vehicles etc.
- Pay attention to overhead power lines! Make sure that no part of the crane ever comes in contact with overhead power lines.

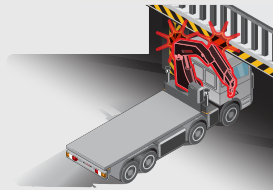
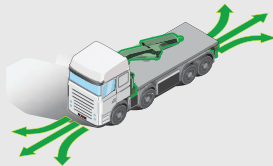
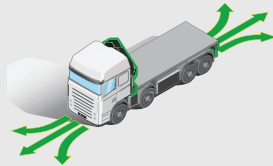

NOTE

- For further instructions, refer to the vehicle's manual(s).
- Make sure that you always obey local traffic rules when driving with a crane.

3.5.4. Use of the Hoist

The hoist is an optional crane component which permits load handling without any or only limited boom movement. An obvious advantage is that the hoist makes it possible to handle loads far

below ground level. Lifting and lowering are achieved by winding/ unwinding the rope. A number of auxiliary components are needed, such as intermediate pulleys and a hook pulley. As an option, a snatch block can be installed to multiply the lifting capacity.

The operator should take care during hoist operation that the rope is not pulled off the drum completely. The hoist control system is fitted with an automatic system to prevent that. Three or five safety windings will always remain on the drum.



DANGER

- Watch out for hazards!
- Always stay clear of the rope, top-roller and the counterweight when operating the hoist.



WARNING

During operation:

- When using the hoist, follow the instructions carefully!
- The counterweight should not touch the top-roller. As a safety measure, distance (A) between them should preferably not be less than a visible gap, to allow getting out of an overload situation and avoid unnecessary stresses in the boom system.

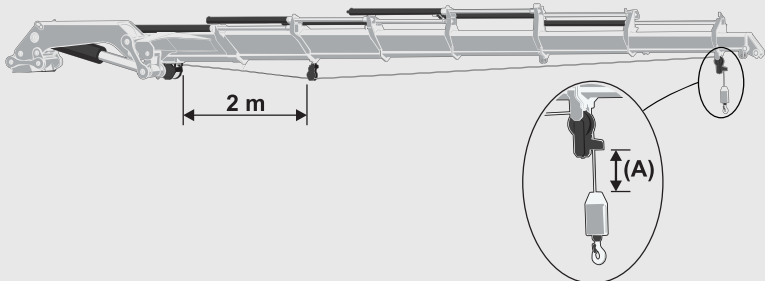

- When working with the extensions retracted, keep a minimum distance of 2m between the hoist and the rope guide on the first extension. This to avoid incorrect winding of the rope onto the drum.

3.5.5. Use of lifting accessories and interchangeable equipment



DANGER

- Only use interchangeable equipment intended to be used on loader cranes as specified in the documents for the equipment.
- When using lifting accessories, follow the instructions supplied with the equipment!
- Watch out for hazards!
- Never try to adjust lifting accessories when you are working on the crane!

After lifting accessories and/or interchangeable equipment have been fitted:

1. Check that they are securely fixed.
2. Only after this, should you use your crane.

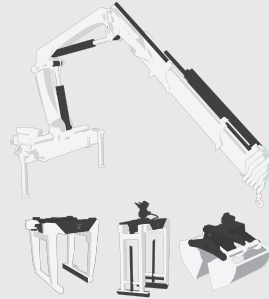

NOTE

When you use equipment such as hoist, JIB, lifting accessories or interchangeable equipment and their necessary components, you add weight to the load. Because of this, the load you can lift is less heavy.



WARNING

Always insert the locking pin in the shaft for all the attachments on the tip of the crane (hook, top-roller, pulleys...).

Do it in the same direction as shown in the picture.

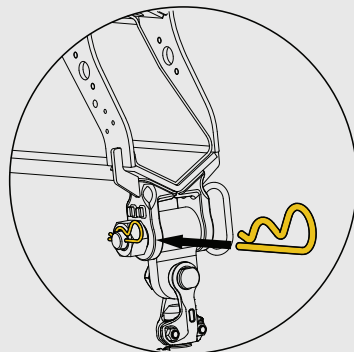

**WARNING**

If you attach/detach equipment to/from the tip of the crane and the boom system is not in horizontal position, stay away to avoid getting caught between the boom extensions as it is normal that they can move towards each other.

Be careful that your fingers do not get trapped.

**WARNING**

Dirt can damage the hydraulic system:

- Clean the couplings, when connecting and disconnecting interchangeable equipment with hydraulic connections.
- Always use the plastic cover protections on the hydraulic connections when disconnecting them.

3.5.6. Use of demountable cranes

**DANGER**

- Make sure that there are no unauthorised persons in the immediate vicinity of the crane. When mounting/demounting the crane on/from the vehicle, people can suffer fatal crushing injuries!
- After setting up, verify that the crane is properly locked!

**WARNING**

Be careful when mounting/demounting the crane on/from the vehicle as rough handling can seriously damage the crane or the vehicle.

3.5.7. Ending crane operation

**DANGER**

Always end crane operation as follows:

- After use, always place the crane in the transport position!
- Withdraw the stabiliser legs and stabiliser extensions.
- Check that the locking mechanisms are properly locked.
- Switch off the operating system.
- Disengage the PTO or power supply after work.
- If you drive with the PTO or power supply engaged, this will cause serious damage to the PTO/gearbox combination.
- Only after doing the above, you can drive the vehicle away.

4. The control system

4.1. Control System SPACE X4

Space X4 is a crane control system.

The control system:

- Monitors the crane's operation and prevents unsafe actions.
- Increases the precision with which you can work.
- Makes operation easier.
- Makes troubleshooting easier.

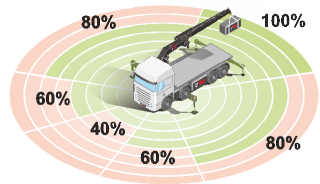

Control system	Control valve	SPACE	Controller
D	V80	SPACE X4	XSDrive



NOTE

The control system provides a large number of functions. Certain functions are standard, others are options.

If you do not use the system for 30 minutes, it will switch itself off in order to prevent draining the truck battery. This feature can be cancelled.

Contact an authorised service workshop.

4.2. How the safety system works

On the crane there are various sensors and indicators which send signals about the crane's load, position and movements to a central microprocessor. The microprocessor then decides how the crane can be operated and stops/reduces prohibited movements/speeds according to the following:

- When prohibited movements/speeds are approached, a warning is given.
- When prohibited movements/speeds are reached:
 - On remote controlled cranes prohibited movements are stopped.
 - On manually operated cranes, all movements are stopped, because when a spool is moved too much, power to the dump valve is cut, all movements are stopped.

Fault monitoring

When there is a fault in the control system it will give an immediate warning.

Depending upon the fault the crane speed and/or the load capacity will be reduced. When the fault is serious, use of the crane is blocked completely.



DANGER

Never try to repair the control system yourself. Repairs may only be made by an authorised service workshop!

4.3. Components of the control system

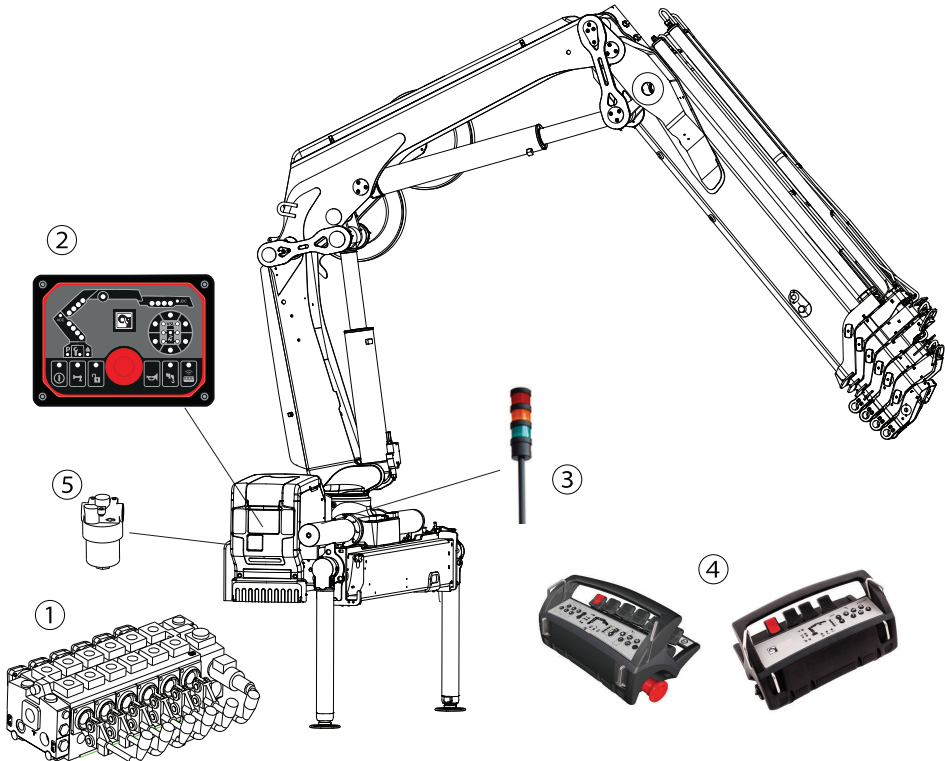

(1) Main control valve
(2) User panel SPACE X4-UI
(3) Lamp pole [Option]
(4) XSDrive controller
(5) Pressure-reducer filter

4.4. Standard symbols and functions of the crane and the stabiliser system

These symbols can be shown:

- On the plates.
- On the control valve levers.
- On the controller (If delivered).



NOTE

If you use a controller to operate your crane, you can read about the symbols displayed on it in the dedicated section of this operator's manual.

By default, the symbol on the controller corresponds to the positive movement of the levers. To operate the opposite movement of that symbol, move the lever on the opposite direction.

Always operate the lever according to the function on the symbol sign.

Basic crane symbols and functions

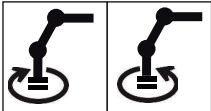
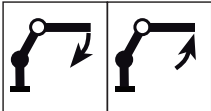
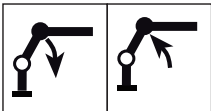
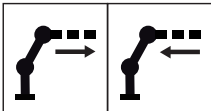
SYMBOLS		FUNCTIONS	SYMBOLS		FUNCTIONS
		Slewing			2nd boom
		1st boom			Hydraulic extensions

Extra symbols and functions (if delivered)

SYMBOLS	FUNCTIONS
	JIB cylinder
	JIB extensions

SYMBOLS	FUNCTIONS
	Hoist
	Rotation tool
	Tool 2

Stabiliser system symbols and functions (if delivered)

SYMBOLS	FUNCTIONS
	Crane stabiliser extension
	Auxiliary stabiliser extension

SYMBOLS	FUNCTIONS
	Crane stabiliser leg
	Auxiliary stabiliser leg

4.5. Main control valve

The speed of a function corresponds to the extent of the lever movement, as long as the oil flow is sufficient. When the oil flow is insufficient, one or more functions will stop.

Standard functions and symbols

The order of the functions is customized for each crane. The image on the right shows an example of a main control valve functions placed on the base.

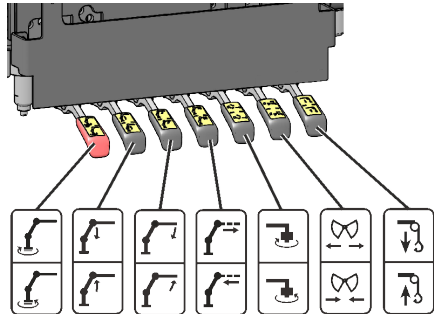

NOTE

For remote-operated cranes the levers on the main control valve are only for emergency operation.

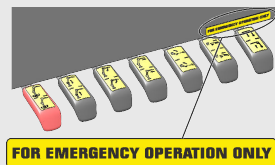

4.6. Different stabiliser control valves

Different stabiliser control valves that you can find on cranes:

- 2-function/4-function control valve included in the main control valve
- 2-function control valve
- 4-function control valve.

You can operate the stabiliser control valve manually or remotely. On remote-controlled cranes the stabiliser control valve levers are only to be used for emergency operation.

4.7. User panel





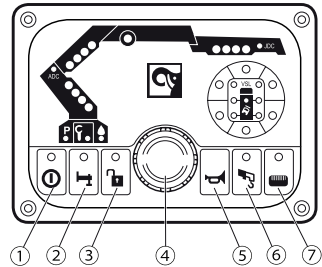



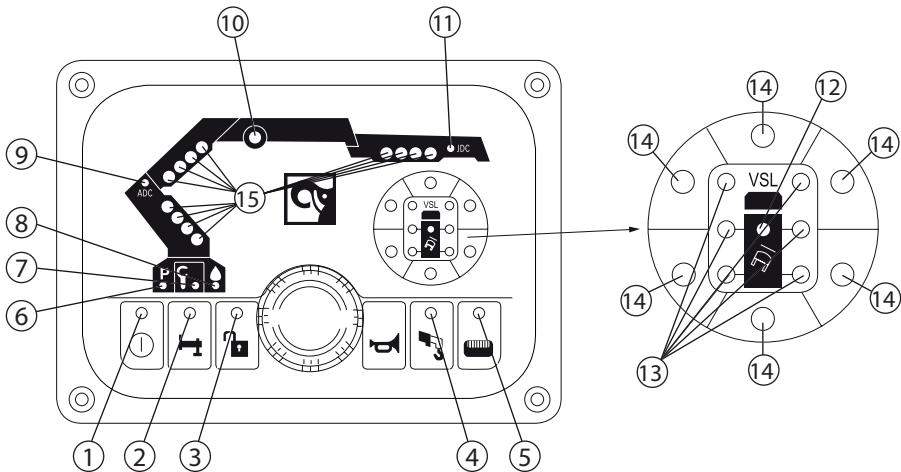

















Buttons:



















- ON/OFF button (1)
To switch the control system on and off.
- Button (2) is stabiliser operation activation to enable operation of stabiliser extensions. The driver must have full view when operating the stabiliser extensions outward.
- Button (3) is used for OLP release if the crane is in an OLP situation and for disconnecting the automatic dump function.
- Stop button (4) is pushed in an emergency.
- Button (5) is used to sound the crane horn.
- Button (6) activates OLP for manual extensions (if fitted).
- Button (7) activates the controller.



4.7.1. Indicator LEDs on User Interface



	Power ON/OFF APO	(1)	<ul style="list-style-type: none">  Green light on: The system is on.  Green light blinking: System on and the stop button has been pushed.  Green light flashing: APO emergency operation time running.  Red light flashing: CAN communication has been lost/ APO override time running
	Stabiliser system activation	(2)	<ul style="list-style-type: none">  Green light on: Stabiliser system active.  Green light flashing: Stabiliser extension is in locked position.
	OLP Release	(3)	<ul style="list-style-type: none">  Red light blinking: OLP Release active (crane, VSL or stabiliser leg)  Green light flashing: Critical error.
	Manual extensions	(4)	<ul style="list-style-type: none">  Green light on: Manual extension mode is active.
	Remote control	(5)	<ul style="list-style-type: none">  Green light on: Remote control is active.  Green light flashing: Button for remote control has been pushed, waiting for connection to hand unit.  Red light on: Radio interference.
P	Parking control	(6)	<ul style="list-style-type: none">  Blue light on: Slew is in parking position.  Blue light blinking: SAF active.
	Service	(7)	<ul style="list-style-type: none">  Green light on: Service needed.  Red light on: Error in the system.  Red light blinking: Critical error.
	Dump valve	(8)	<ul style="list-style-type: none">  Blue light on: Dump activated.
ADC	ADC	(9)	<ul style="list-style-type: none">  Blue light on: Indicates that the ADC feature is active.

	Hoist	(10)	<ul style="list-style-type: none">  Green light on: Hoist mode.  Red light flashing: 3 rolls left on the hoist drum.  Red light blinking: 90% of OLP pressure.  Red light on: 100% of OLP pressure.
JDC	JDC	(11)	<ul style="list-style-type: none">  Blue light on: Outermost extension fully retracted and the JIB has increased capacity (JDC mode).
	VSL [option]	(12)	<ul style="list-style-type: none">  VSL-OLP reached.
	Stabiliser legs [option]	(13)	<ul style="list-style-type: none">  Green light on: Stabiliser leg set.  Red light on: OLP stabiliser leg.
	Stability sector (Cranes with VSL feature)	(14)	<ul style="list-style-type: none">  Red light on: 0-19% stability.  LED off: 20-69% stability.  Yellow light on: 70-89% stability.  Green light on: 90-100% stability.
	Stability sector (Cranes without VSL feature)	(14)	<ul style="list-style-type: none">  Green light on: regardless of the situation.
	Cylinder pressure	(15)	<ul style="list-style-type: none">  1 of 4 green light on: 50% of maximum pressure reached.  2 of 4 green light on: 70% of maximum pressure reached.  3 of 4 red blinking light: 90% of maximum pressure reached.  4 of 4 red light on: 100% of maximum pressure reached.  4 of 4 red running light: OLP release activated.

LED test for the User Interface, see Daily inspection.

4.8. Lamp pole [option]

The lamp pole is equipped with 3 lamps. Flashing/light up: green, amber and red.

- green: start up remote control
- amber: prewarning OLP
- amber and red: OLP



4.9. XSDrive controller

Controller XSDrive has either four or six levers, or two or three joysticks for proportional functions programmed in the different menu selections. The controller normally communicates with the crane via radio but can also be operated via cable.

Radio communication is dependent on:

- Transmitter, fitted in the controller.
- Receiver box, fitted on the operating base.

The Receiver box consists of a combined radio receiver and 12 outputs for servo valves. The status of the receiver is visible on the controller. In case of radio interference, it is possible to change the channel by pushing button . There is a maximum of 12 channels available.



WARNING

When the controller is in use (stop button released), keep a distance of minimum 1 meter between the controller and the crane or truck because of possible electromagnetic interference.

Cable connection [option]

The cable (2) is intended to be used for short-term operation and when pairing in conjunction with the replacement of controller or receiver. Connection is made between the controller (3) and the receiver box (1). Radio communication is automatically disabled when the cable is connected.

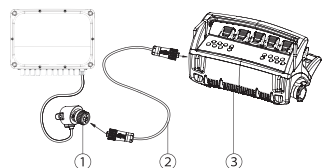

4.9.1. Indicator LEDs on XSDrive controller

The indicator LEDs on the controller indicates errors, stability, cylinder pressure etc. The appearance of the panel differs somewhat depending on if the controller has levers or joysticks.

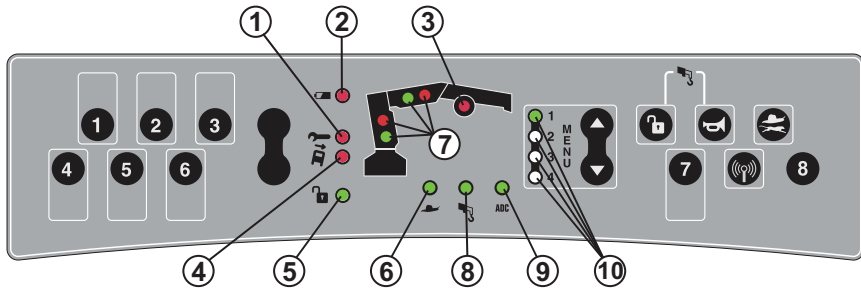

	Service	(1)	Red light on: Error detected in the system.
	Battery	(2)	Red light on: Low power
	Hoist LED	(3)	Red light flashing: 90% of maximum pressure Red light on: 100% of maximum pressure
	VSL [option]	(4)	Red light on: VSL-OLP. Vehicle has reached a stability limit. (Also all the 1st boom diodes will light red).
	OLP Release	(5)	Red light on: OLP Red light blinking: OLP Release.
	Low speed	(6)	Green light on: Reduced speed. For normal speed, see section "Buttons"
	Cylinder pressure LEDs	(7)	Lower LEDs green light on: 70% of maximum pressure Lower LEDs, red light flashing: 90% of maximum pressure Lower and upper LEDs red light: 100% of maximum pressure
	Manual extension	(8)	Green light on: Manual extension activated
ADC	ADC	(9)	Indicates that the ADC feature is active.
	Menu LEDs	(10)	Light on: Indicates active menu

4.9.2. Buttons

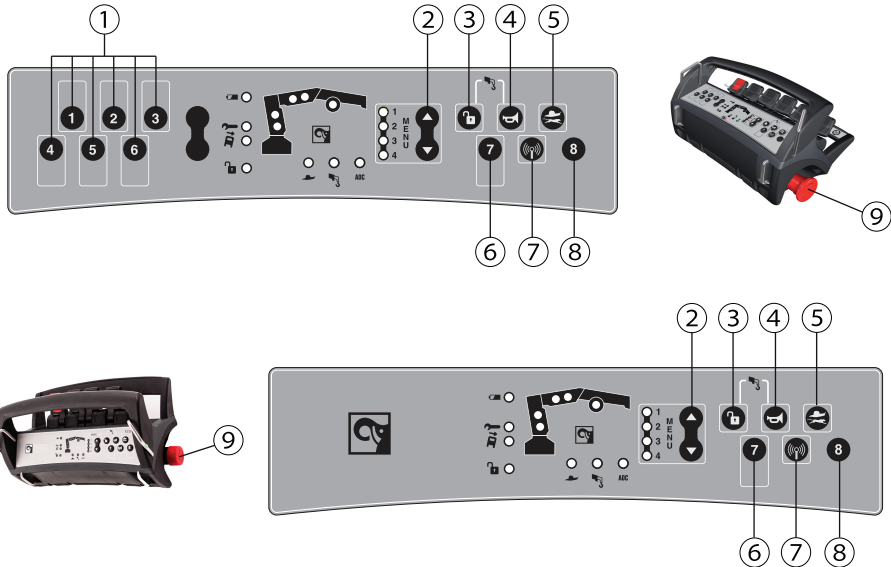

(1)	ON/OFF buttons [option]	Buttons for 7 extra ON/OFF functions (engine ON/OFF, engine speed, horn etc.)
(2)	Menu selection	Push to change between menus 1 to 4.
(3)	OLP release	Push and hold the button while you operate a pressure reducing function.
(4)	Horn	Push to operate the horn.
(3) & (4)	Manual extensions	Push at the same time to activate the manual extension.
(5)	Speed selection	At the start, you have maximum operational speed. Push the button to operate the crane with decreased speed. Push it again for maximum speed.
(6) & (8)	Not in use	
(7)	Channel shift	Push to change radio channel. There are 12 channels in total.
(9)	Emergency stop button	When you push the button, you stop all crane functions. To release it, turn the button clockwise.

Locking the controller

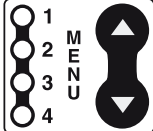
	<ol style="list-style-type: none"> 1. Push the emergency stop button. 2. Push and hold both arrows on the toggle button and release the emergency stop button at the same time. 3. The 4 LEDs flash at the same time. Now you cannot operate the controller. 4. Push the emergency stop button.
---	---

Unlocking the controller

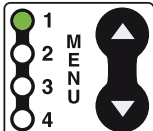
	<ol style="list-style-type: none"> 1. Make sure that you pushed the emergency stop button. 2. Push and hold both arrows on the toggle button and release the emergency stop button at the same time. 3. The 4 LEDs flash at the same time for 5 times. 4. LED 1 comes on. (Start menu)
---	--

4.9.3. Menus

The functions presented in each menu can be customised depending on crane configuration. It can be changed by an authorised service workshop.

The table below shows an example:

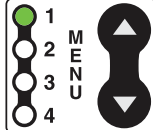
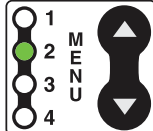
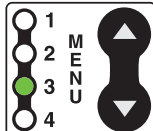
<p style="text-align: center;">MENU 1</p> 	<p>Slewing, 1st boom, 2nd boom, extension boom, tools JIB, hoist, etc.</p>
<p style="text-align: center;">MENU 2</p> 	<p>[option] (If crane is equipped with extra remote controlled stabiliser system)</p>
<p style="text-align: center;">MENU 3</p> 	<p>[option] Slewing, attachment. (If crane is equipped with remote controlled stabiliser): left and right stabiliser extension, left and right stabiliser leg.</p>

<p>MENU 4</p>	<p>[option] Similar to menu 3 but for extra stabiliser legs</p>
----------------------	---

4.9.4. Standard function symbols

The function corresponding to each lever depends on the configuration of the specific crane. The table below shows examples:

XSDrive levers 6F

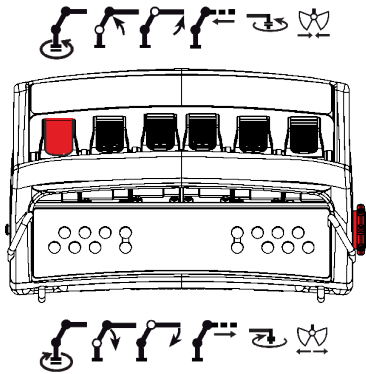

XSDrive levers 4F

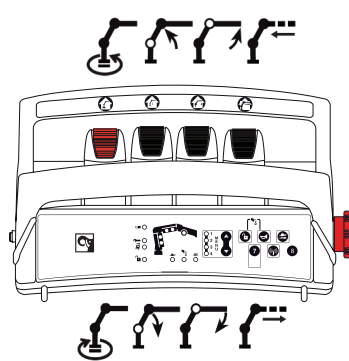

SAF symbols

The order of the levers/buttons is customized.

- SAF - fold/unfold the boom system (1).
- SAF - unfold/fold the boom system (2).
- SAF - confirm extension in (3).



4.9.5. Battery and battery charger XSDrive

Battery

A fully charged battery provides approximately 5-8 hours use (at 25°C, 77°F) and the voltage level is approximately 8.4 V. When the battery is about to wear out an indicator LED on the controller turns steady red and the horn will sound twice. Push the emergency stop button before changing the battery. Note that the battery voltage remains between 7.6 V and 7.5 V for a long time. Therefore, the battery voltage cannot be used to estimate remaining hours of use.

Battery charger

The battery charger is to be fitted in a protected environment, preferably in the cab.

LED (1) is lit continuously when the battery charger is ready for use. Place the battery in the charger. LED (2) flashes slowly during recharging and has a steady light when the battery is fully charged.

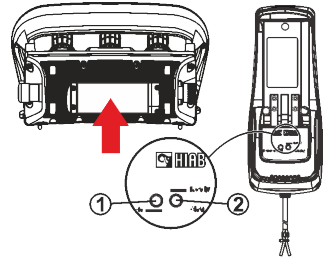

Charging time

The normal charging time for a flat battery, is approximately 3 hours. Operating ambient temp: Battery = 0° to + 45°C (32°F to 113°F).



NOTE

A charged battery is a concentrated energy source. Never store a charged battery in a toolbox or similar, where there is a risk of a short due to contact with metal components. Used batteries should be taken care of according to the local regulations.

4.10. Pressure-reducer filter

For remote-controlled cranes, the pressure-reducer filter is on the base. The oil goes through the filter and then to the positioner(s).

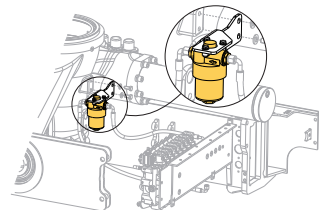

4.11. Control platform [option]

The platform is placed on the left side of the crane, with perforated anti-slip plate.

- For manually controlled cranes:
The platform is equipped for using tools and operated using six levers with control valve on the top.
- Remote controlled cranes:
The platform is equipped with a holder for the controller.
The control valve is placed on the base.

The platform is connected with OPS system, to stop the boom system slewing into the platform.

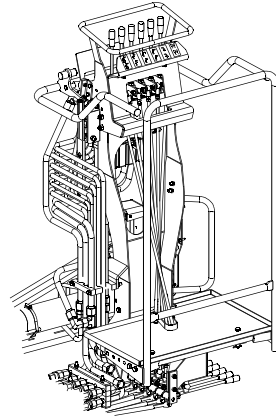

DANGER

Never operate the crane in or out of parking position from the platform.

5. Starting crane operation

5.1. Starting operations

- **General case:**

Place the vehicle on a flat and firm surface. The vehicle inclination during crane operation must **not be more than allowed in the Technical Data for your crane**. If this value is exceeded, unintentional crane movements can occur.

To determine the inclination of the truck, check the spirit level on the crane. When the bubble is in the middle of the gauge, the crane is in horizontal position. When the bubble is between the two circles, the crane inclination is between 0° and 5°.

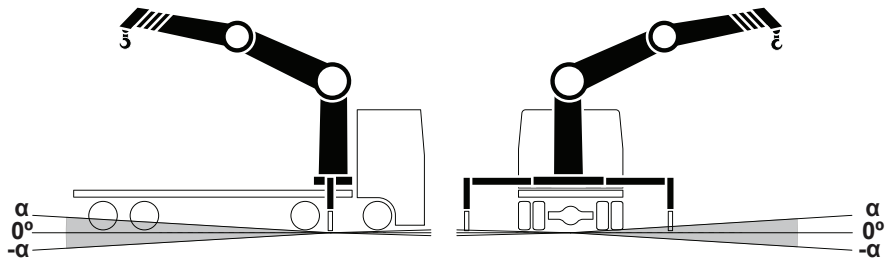
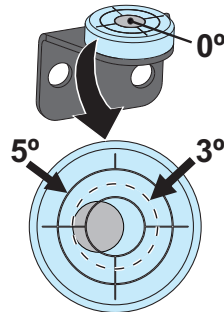

- **Working with boom system beyond 60°**

To avoid side deflection and in order to guarantee the safest operation when working with e.g. lifting accessories, interchangeable equipment and/or Hoist applications, the vehicle has to be completely levelled in any direction ($\alpha=0^\circ$).

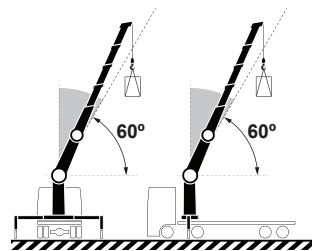

NOTE

- Operating the crane in to and out of transport position must also be done with the vehicle completely levelled.
- Activate the parking brake and place chocks under the wheels to prevent vehicle movement.

Engage the PTO

1. Activate the parking brake and place chocks under the wheels to prevent vehicle movement.
2. Engage the PTO (Power Take Off) and bring the vehicle engine to the correct rpm.



NOTE

- Rpm too high: the oil in the hydraulic system might overheat.
- Rpm too low: during crane operation, the vehicle engine could stall.
- The maximum rpm may depend upon a governor on your PTO combination.



CAUTION

Close the driver's cab to prevent access to unauthorised persons.

Start the control system

The operating levers must be in neutral position before start up. To start the control system, press the ON/OFF button  on the User Interface.

The LED above the button starts to lights up. The system will check itself (2-4 seconds).

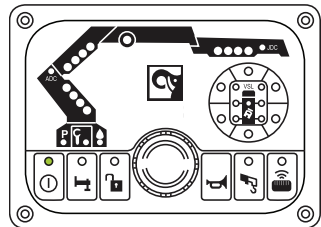

Start the controller

1. Fasten the controller to a waist belt, or shoulder-/neck strap, in the most comfortable operating position. The emergency stop button should be on the right-hand side.
2. Push button  on the User Interface. The LED above that button will blink.
3. To activate the controller, pull out the emergency stop button by turning it clockwise.

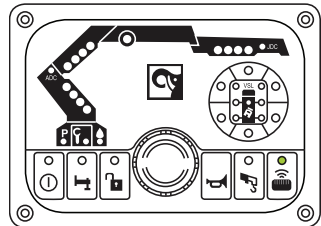

Indications XSDrive

The first LED in the LEDs menu starts blinking. When communication has been established, the LED will give a steady light = ready for use.

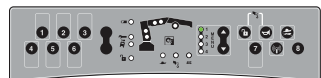

5.2. Set the stabiliser system

To ensure the maximum stability of the vehicle, all the stabiliser extensions and legs must be fully extended and set to the ground without lifting the wheels from the ground.

- **Cranes with VSL:** when the stabiliser extensions are not fully extended, the lifting capacity is optimised by the VSL feature to ensure the maximum stability of the vehicle.
- **Cranes without VSL:** crane must be operated with the stabiliser extensions fully extended and the stabiliser legs set to the ground without lifting the wheels from the ground, otherwise the stability of the vehicle will not be ensured.

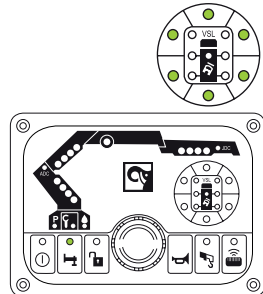

DANGER

For cranes without VSL the operator is the responsible to make sure that the vehicle is stable while lifting a load and the maximum load is not exceeded.



WARNING

If your vehicle has a front auxiliary stabiliser system, with one or two legs, make sure that all legs are correctly set to the ground before you start operating the crane.

Stability sector indication

The operator must have a full view of the stabiliser system when operating it. To confirm a full view of the stabiliser system, button  is pushed on the User Interface on the side where the stabiliser system is going to be operated. As soon as the button has been pushed, the LED for the active stabiliser leg will light green.

- **Cranes with VSL:** the stability sector LEDs will indicate the crane capacity in six different sectors due to stability.
- **Cranes without VSL:** the stability sector LEDs will light green regardless of the situation. The operator is the responsible to make sure that the vehicle is stable while lifting a load.

Stabiliser system and ground conditions

Always:

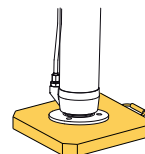

- Make sure that the ground can support the load that the stabiliser leg imposes on the ground. (*)
- Make sure that the ground is not undermined.
- Use the extra support plates that are large and firm enough for your crane model.

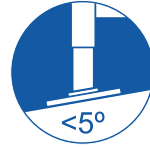

The maximum permitted ground inclination under the stabiliser leg plate is 5°.

(*) The maximum load that the stabiliser leg can impose on the ground:

EFFER-Cranes	P (kN)
65H / 65D / 80H / 80D / 100H / 105D / 125HP	150



NOTE

Sign that shows the maximum force that the stabiliser legs can apply to the ground.

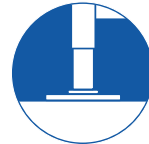



DANGER

Check that the extra support plates do not bend or sink into the ground.



Do not lower the stabiliser legs on the edge of an embankment, soft ground, hollows, etc... Lower the stabiliser legs only on to a flat, firm and stable surface.

5.2.1. Activate the stabiliser system

Manually controlled stabiliser system:

1. Make sure manual control is active. If not, push the button  on the User Interface
2. Push the button  to activate stabiliser system operation.

Remote controlled stabiliser system:

1. Make sure remote control is active. If not, push the button  on the User Interface.
2. Select the menu for stabiliser system on the controller.
3. On the side where the stabiliser extensions are to be operated outwards, push the button  to activate stabiliser system operation and confirm the view. The stabiliser legs can be driven up and down regardless of the side.

5.2.2. Extend the stabiliser extensions

The procedure of setting the stabiliser extensions differs depending on the type of stabiliser extensions. Repeat the instructions for the stabiliser extension on the other side of the vehicle. For auxiliary stabiliser system [option]: Repeat the process.

Manually controlled stabiliser extensions

Unlock Stabiliser locking devices (2) and (3). Take a firm grip around handle (1), and pull to extend the stabiliser extension and lock with the handle (3).

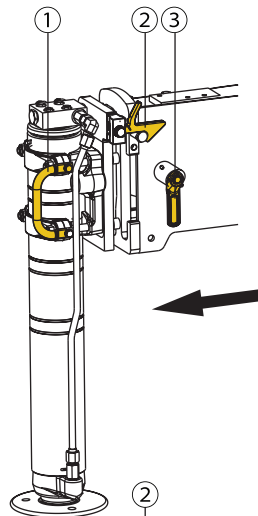

Hydraulically controlled stabiliser extensions

Unlock the Stabiliser locking device (2) [option] and extend the stabiliser extensions with the levers on the valve or the controller depending on your crane configuration.

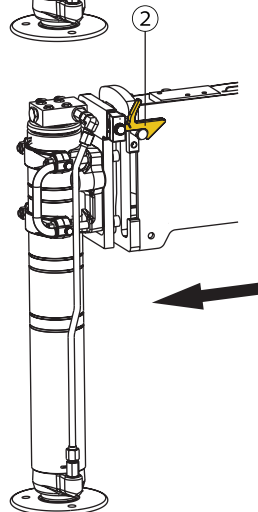

5.2.3. Set the stabiliser legs

The procedure of setting the stabiliser system differs depending on the type of stabiliser system. Repeat the instructions for the stabiliser extension and leg on the other side of the vehicle. For auxiliary stabiliser system [option]: Repeat the process.



WARNING

Take care not to lower the stabiliser leg onto your foot.



NOTE

For cranes with VSL the stabiliser leg downward movement is automatically stopped at a pre-given force level. To exceed this pre-given force level, operate the stabiliser leg down once again.



DANGER

Always ensure that the stabiliser legs and stabiliser extensions are in working position and securely locked.

Never operate up any stabiliser leg if you have load on the crane.



NOTE

At the end of the operation, do a check of the levelling of the vehicle with the spirit level. If necessary, adjust the stabiliser system.

Put the extra support plates

- Put the extra support plates under the stabiliser leg plates (if necessary).

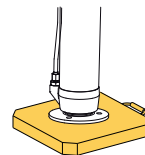

DANGER

Do a check that the support plates do not bend or sink into the ground!

Non-tiltable stabiliser legs

1. Make sure that the stabiliser extensions are extended.
2. Operate the stabiliser leg downwards until it is set to the ground.

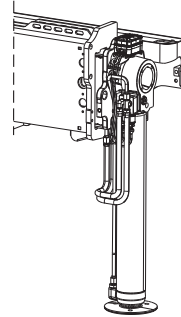

Manual tiltable stabiliser legs

1. Make sure the stabiliser extensions are extended a little
2. Unlock the stabiliser leg lock (2), that holds the stabiliser leg in the transport position.

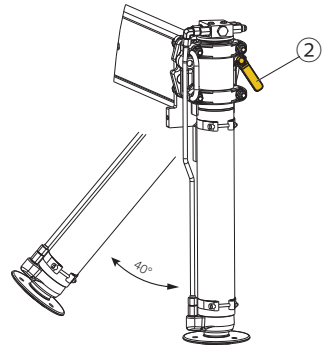

WARNING

Do not stand in the stabiliser leg tilting area.

3. Tilt the stabiliser leg downward.
4. Lock the stabiliser leg lock (2).
5. Extend the stabiliser extension. For manual extensions, lock the extension
6. Operate the stabiliser leg downwards until it is set to the ground.

Manually tiltable stabiliser legs with gas spring support



DANGER

Do not stand in the stabiliser leg tilting area.

1. Make sure the stabiliser extension is extended and the stabiliser leg can rotate freely of the vehicle.
2. Place your right hand on the handle (3) while unlocking the stabiliser leg (4) with your left hand. Make sure the leg drops in a controlled movement until it stops. Push the handle until the leg is pointing downwards.
3. Lock the stabiliser leg with the handle (4).
4. Extend the stabiliser extension. For manual extensions, lock the extension.
5. Operate the stabiliser leg downwards until it is set to the ground.

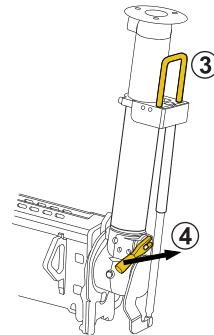

Mechanically controlled tiltable stabiliser legs

1. Make sure the stabiliser extension is extended a little and the stabiliser leg can be rotated freely of the vehicle.
2. Unlock the stabiliser leg lock (1).
3. Use the stabiliser leg lever to tilt the stabiliser leg. Make sure that you have full control of the movement to avoid risk of crushing.
4. Lock the stabiliser leg lock (1).
5. Operate the stabiliser leg downwards until it is set to the ground.

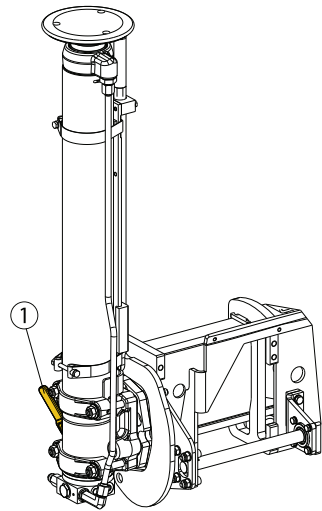

5.3. Operate the boom system out of transport position



WARNING

- A crane with interchangeable equipment and/or optional crane components can differ from the operations described in this section. For this reason, study the operating instructions for any interchangeable equipment and/or optional crane components carefully.
- Always ensure that the stabiliser extensions and legs are in working position and securely locked before operating the boom system out of parking position.



DANGER

Always operate a manually controlled crane from the position shown in the image!



1. If the stabiliser system is manually controlled, push button  on the User Interface to activate remote control.
2. If using remote control, push button (1) on the controller to change the menu into crane operation.

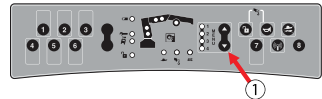
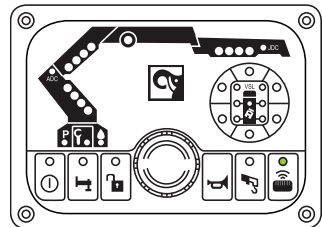

NOTE

As soon as you have selected remote control operation, it is no longer possible to operate the main control valve levers.

5.3.1. BDA Boom Deployment Assistance [option]

BDA is a feature in SPACE that prevents the operator to move the 2nd boom and extensions in the wrong direction when operating the crane in to or out of transport position.

- **Operating the crane to transport position:**

When the angle β is $>135^\circ$ between the horizontal and 2nd boom, the system does not allow to raise the 2nd boom or to move extensions out/in.

Press the button for release to allow 2nd boom and extensions movements.

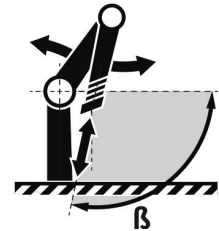
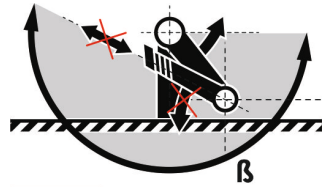

DANGER

Only use the BDA override to get the crane out of a locked position.

- **Operating the crane out of transport position:**

When the angle β is $<135^\circ$ between the horizontal and 2nd boom, 2nd boom and extensions can move without any restrictions.

5.3.2. Operate the boom system

1. Operate the 2nd boom (1) fully against the underside of the 1st boom (2).
2. Raise the 1st boom (2).

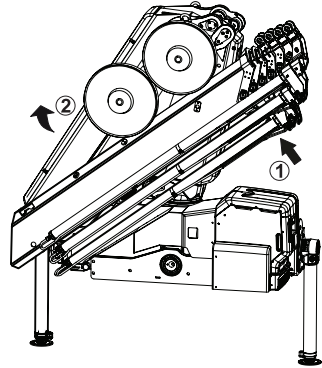

3. As soon as the 1st boom is raised to an angle where the 2nd boom can go free from the crane base, raise the 2nd boom (3).
4. Slew the crane to working position. The crane is ready for use.

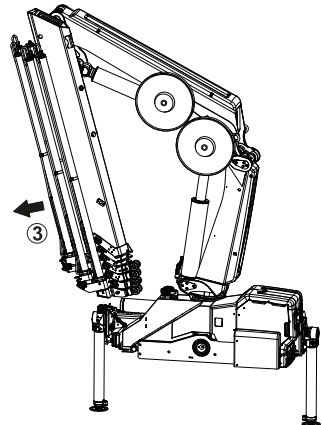

5.3.3. SAF Semi Automatic Folding [option]

SAF is a feature which allows the operator to fold or unfold the boom system in one single sequence using only one lever.



Fold the boom system semi automatically



WARNING

Never use SAF with mounted tools



WARNING

For hoist:

Change from hoist to hook operation.

1. Make sure there is enough space for the crane to fold semi automatically.



DANGER

In case the situation does not allow semi automatic folding, use crane mode to put the boom system to folded position.







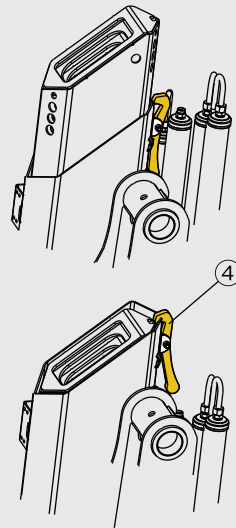

NOTE

For cranes with S-boom:

Before you select SAF menu, it is necessary to extend the boom extensions until the catcher (4) drops. Retract the extensions carefully until the catcher secures the boom. By selecting the SAF menu, you confirm that the extensions are fully retracted and that the catcher locks the boom. The SAF sequence can now be started.



2. Select menu for SAF.
3. If SAF is not configured in a separate crane menu, push button  to activate it.
4. Operate lever on the controller until the extensions are retracted:
 - XSDrive 
 - CombiDrive 
5. Confirm that the extensions are retracted on the controller:
 - XSDrive 
 - CombiDrive 
6. Continue to hold lever on the controller until the boom system is folded:
 - XSDrive 

- CombiDrive 

**DANGER**

During this movement, the boom system will fold itself. Make sure that the boom system does not cause injury or damage, if so, release the lever immediately.

7. If SAF is not configured in a separate crane menu, push button  to deactivate it.

6. During operation

6.1. Features

The control system provides a large number of features. Certain features are standard, others are options.

6.1.1. Controlling the crane speed with the controller XSDrive

At startup, the system by default is set to full speed. To reduce the speed, push button  once. The low speed LED will light continuously. By pushing the button again, the crane returns to full speed and the LED goes out.

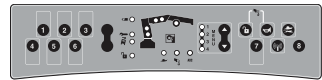

When pushing the speed selector button, all levers must be in neutral.



NOTE

The crane speed will depend upon the crane functions you are using and how many crane functions you operate at the same time.

6.1.2. Supervision of spools

If a valve spool movement is greater than the equivalent lever or joystick movement on the controller, a safety feature is tripped, and all crane movements stops.

This occurs if a control lever on the valve is moved while the remote control is engaged.

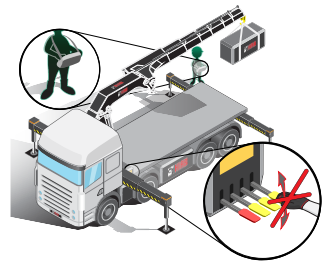

6.1.3. OPS Operator Protection System [option]

OPS is a system that protects the operator from the boom system's movements when operating the crane.

The OPS system is integrated in the control system, and it uses a sensor on the slewing system and tilt indicators on the boom system, to indicate the position of the crane.

It creates a virtual cage around the area where the crane operator stands, while manually operating the crane.

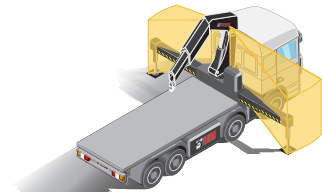

6.1.4. APO Automatic power off

APO is a feature which automatically switches off the power to the control system. It consists of:

1. Timeout controlled power off. (30 minutes by default).

2. Parking brake controlled power off.

Through the vehicle's parking brake, APO offers a feature which ensures that the control system is off when the vehicle is moving. When parking brake is released, the control system receives a signal and shuts OFF.

For emergency operation

During 5 seconds, it is possible to activate the control system by pushing the ON/OFF button on the User Interface.

6.1.5. ADO Automatic Dumping of Oil

If a lever is not moved for 3 seconds, this feature diverts the oil to the tank, thereby preventing the oil from overheating. The next lever movement stops the dumping and it functions as normal.

6.1.6. ASC Automatic Speed Control

The ASC feature automatically provides the extra power by reducing the speed smoothly, when working close to the rated capacity. When the load decreases, normal speed is restored.

ADC Automatic Duty Control

The purpose of the ADC feature is to optimise the use of the steel structure.

The first boom pressure sensors indicate if there is a positive or negative pressure on the first boom.



Adjusted capacity

- If the crane is pressed down, the sensors indicate a negative pressure and the lifting capacity is adjusted during the complete lifting cycle. When the lifting cycle ends, the capacity will return to full capacity.

Full capacity (ADC mode)

- ADC lamps light up. If the sensors indicate a positive pressure, the lifting capacity is normal during the complete lifting cycle.

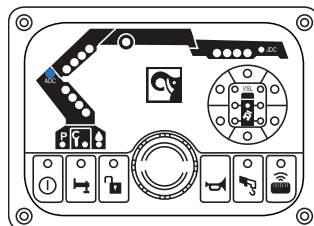

6.1.7. Slewing sector [option]

Within slewing sector, lifting capacity can be reduced due to stability. The overload warning will be given at a lower load in the limited sector than outside the sector. In case of an overload warning you may slew out of the sector but not further into it.

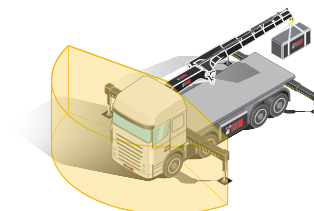

6.1.8. VSL Variable Stability Logic [option]

The VSL feature detects the position of the stabiliser extensions and that the stabiliser legs are pressed to the ground. This optimise the crane lifting capacity in relation to the vehicle's stability.

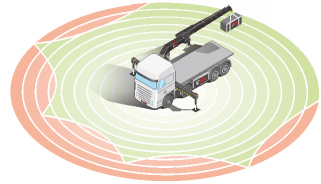

The VSL diagram

After the installation on the truck, the installer prints unique stability diagrams for each crane. In the diagrams, each colored curve shows the cranes stable area and the maximum working pressure in the 1st boom cylinder with stabiliser extensions in different outreach. The more you extend your stabiliser extensions the more stability and crane's capacity you will get.

The diagram shows 9 different sectors surrounding the crane and in each sector there is a percentage shown. A percentage of 90 indicates that the available working pressure is reduced to 90% in this sector.

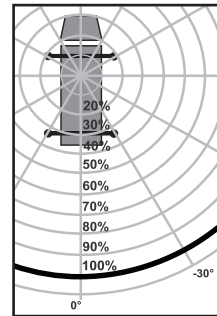

Examples of stability diagrams:

Stability diagram (One ON/OFF sensor on stabiliser extensions)

With one On-Off sensor, you see two curves and two positions of the stabiliser extensions:



Not fully extended 0-99% (shown as 0%)



Fully extended (100%)

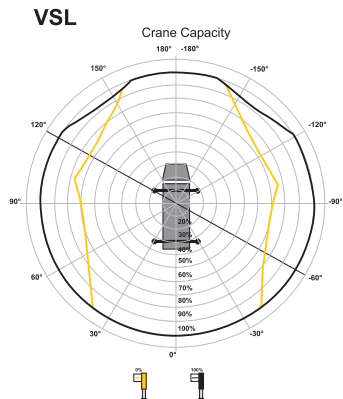

Stability diagram (Two ON/OFF sensor on stabiliser extensions)

With two On-Off sensors, you see three curves and three positions of the stabiliser extensions

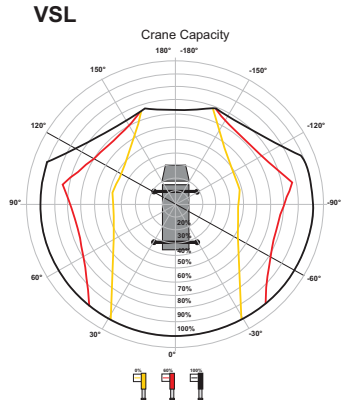
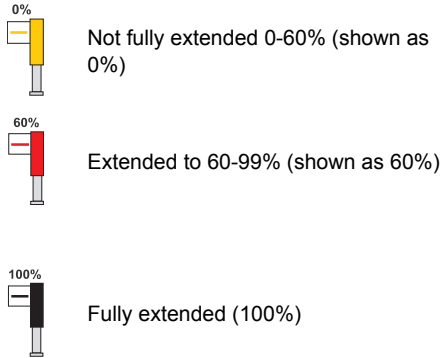

Stability diagram (Variable analogue sensor(s) on stabiliser extensions)

With variable sensors any position can be read. You see five curves and five positions of the stabiliser extensions.

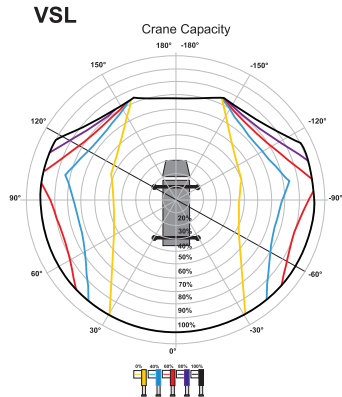
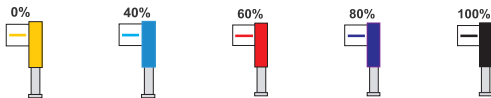

NOTE

For cranes with JIB, you will have an additional diagram.

The Lifting Capacity Diagram:

The software creates six different capacity diagrams with the stabiliser extensions in different positions (represented in the truck drawing). For cranes with JIB, another six capacity diagrams will be automatically generated.

The software calculates three loads:

- **CURVE A:** Maximum load at maximum outreach (1).
- **CURVE B:** Intermediate load between curve A and C.
- **CURVE C:** Maximum momentum curve (2).

The three coloured curves represent the three different loads. These loads are represented by the position of the crane in each sector (degrees) and also by the outreach of the boom extensions (meters or feet and inches).

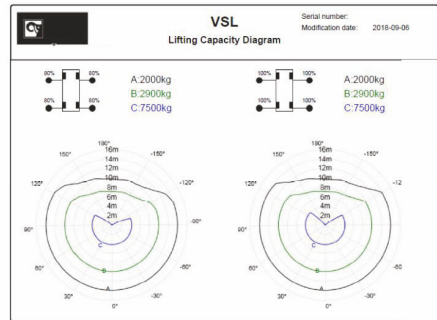
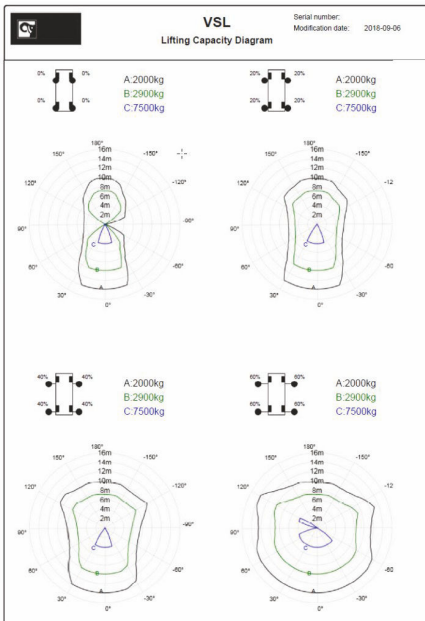
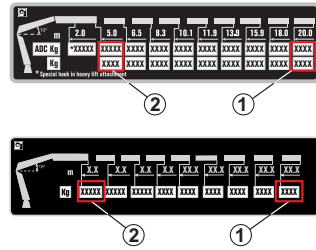

NOTE

Speak to your authorised service workshop to request these diagrams for other loads.

6.1.9. LSS-V Load stabilising system-vertical [Option]

LSS-V reduces vertical oscillations in the boom system. This feature makes it easier to handle loads at long outreach.



WARNING

Disable LSS-V when working in confined spaces. Compensating movement can cause the crane to collide with obstacles.

If LSS-V is enabled when SPACE is switched off, it will be active when SPACE is started again.

Activate and deactivate LSS-V (By default) with the controller XSDrive

Push button (6) to activate and button (8) to deactivate.

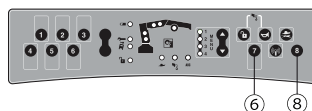

6.2. OLP (Overload protection)

OLP is a safety function that prevents overloading of the crane. With 90% of the maximum permitted pressure the warning lamps on the stabiliser legs double blink. When 100% of maximum pressure is reached the warning lamps will blink.

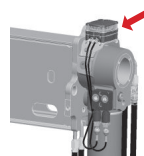

Boom system OLP

When 100% of the maximum permitted pressure is reached, OLP cuts in and stops all functions that increase the pressure.

The pressure level in the first and second boom is indicated by the LEDs on the user interface:

- 50% of maximum pressure – 1 of 4 LEDs light green
- 70% of maximum pressure – 2 of 4 LEDs light green
- 90% of maximum pressure – 3 of 4 LEDs blinking red
- 100% of maximum pressure – 4 of 4 LEDs light red

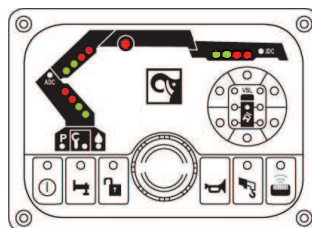

NOTE

Do not operate heavy loads with the extensions fully retracted. In an OLP situation, it is an advantage to be able to retract the extensions.

Stabiliser system OLP [option]

If a stabiliser leg is overloaded, slewing is stopped in the direction towards the stabiliser leg where the OLP occurs. The crane stops. The warning lamps on the stabiliser legs will blink. On the user interface the LED for the overloaded stabiliser leg will light red. Move the levers to neutral and only operate permitted (pressure-reducing) functions.

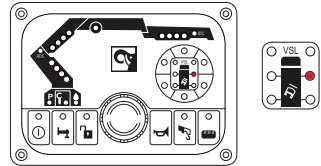

VSL - OLP [option]

VSL-OLP occurs when there is a risk of instability of the vehicle. Slewing is stopped towards the instability direction and the crane stops. On the user interface the LED for VSL-OLP and the LEDs for the 1st boom will light red. Move the levers to neutral and only operate permitted (pressure-reducing) functions.

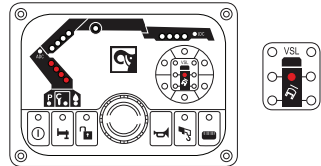

OLP manual control

If one prohibited function is used, all functions will stop. The crane will be fully operational as long as only allowed functions are used.

6.3. OLP - indications on the controller

XSDrive

Boom system OLP: The cylinder LEDs indicate a percentage of maximum pressure:

- 70% of maximum pressure reached - lower LED on each cylinder light green
- 90% of maximum pressure reached - lower LED on each cylinder flash red
- 100% of maximum pressure reached - both LEDs on each cylinder light red

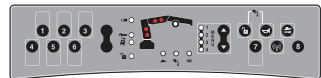

Stabiliser system OLP [option]: No indication on the controller. See indications on the User Interface.

VSL-OLP [option]: The LED for VSL becomes red.

6.4. To release OLP

If all functions have been blocked due to OLP, it is possible to temporarily release OLP and operate an appropriate crane function to correct the overload situation. OLP release is active in 5-second intervals. After each 5-second interval of OLP release, there is a waiting time before the release operation can be activated again. The waiting time will increase in three steps: 30, 60 and maximum 90 seconds. During each 5-second interval, only one function at a time can be operated. Extension out cannot be operated at all. The 5-second interval starts to count as you move the lever.



DANGER

Only use the OLP release to get the crane out of a locked position. Never use the OLP release to overload the crane deliberately!



NOTE

In case of a crane breakdown, the use of OLP release will be part of the investigation. If the use of OLP release is too excessive, it might affect warranty.

OLP release on User Interface

Push and hold button  to temporarily release OLP and operate an appropriate crane function to correct the overload situation. The cylinder pressure LEDs on the User Interface perform a running light. The LED for padlock symbol will blink red.

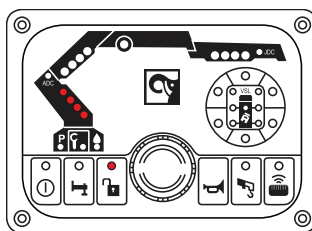

OLP release on controller XSDrive

Push and hold the button  on the controller whilst operating load reducing functions. On the User Interface the cylinder pressure LEDs perform a running light. The LED for padlock symbol will blink red.

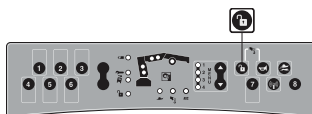

6.5. Manual extensions [option]

Operation with manual extensions

- Always extend the hydraulic extensions first, then the manual extensions.
- The use of manual extensions should be restricted to the longest outreach needed. When this reach is not needed, the manual extension should be retracted.



DANGER

Do not stand in front of moving parts. They may eventually move and cause injuries.



WARNING

Never use the SAF feature with the manual extensions extended.



CAUTION

To operate the crane to transport position, do not forget either dismantle manual extension or place manual extension completely into the last hydraulic extension.

To extend the manual extensions

1. Locate the boom system as close as possible to the horizontal position, but low enough to reach the extension by hand.
2. Stop the crane, by pressing the stop button.
3. Remove the locking device (1) and the locking pin (2).
4. Extend the manual extension fully by hand.
5. Secure the manual extension, by locking the pin (2) and locking device (1).

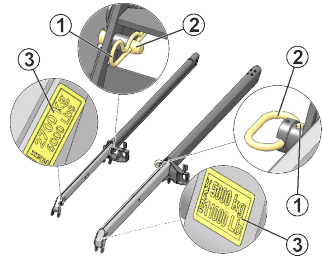

DANGER

- Make sure that the locking device is properly locked.
- Each manual extension has a sign (3) for the maximum load that can be handled.
- Do not lift loads heavier than the values stated on the hook attachment.

To lift heavier loads than specified on the sign (3), the hook position must be moved to the nearest hydraulic extension, in accordance with the load plate on the crane.

To retract the manual extensions

1. Locate the boom system as close as possible to the horizontal position, but low enough to reach the extension by hand.
2. Stop the crane, by pushing the stop button.
3. Remove the locking device (1) and the locking pin (2).
4. Retract the manual extension fully by hand.
5. Secure the manual extension, by locking the pin (2) and locking device (1).

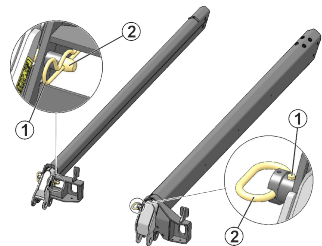

DANGER

- Make sure that the locking device is properly locked.

Activate and de-activate OLP for manual extensions on the User Interface



WARNING

You must switch the OLP on and off manually for additional manual extensions!

Activate:

Push button  on the User Interface.

The manual extensions are now included in the OLP protection. The lifting capacity will be reduced automatically. The lamp for  lights up on the User Interface.

De-activate:

Push the button again. The lamp for  goes out.

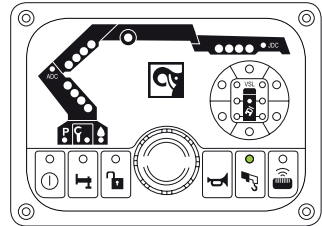

Activate and de-activate OLP for manual extensions on the XSDrive controller



WARNING

You must switch the OLP on and off manually for additional manual extensions!

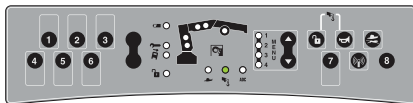

Activate:

Push buttons  and  on the controller.

The manual extensions are now included in the OLP protection. The lifting capacity will be reduced automatically. The lamp for  lights up on the User Interface.

De-activate:

Push the buttons again. The lamp for  goes out.

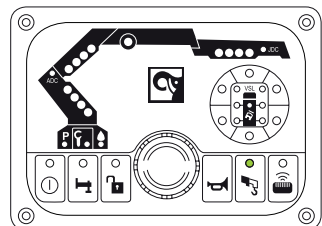

6.6. How to change from hoist to hook operation

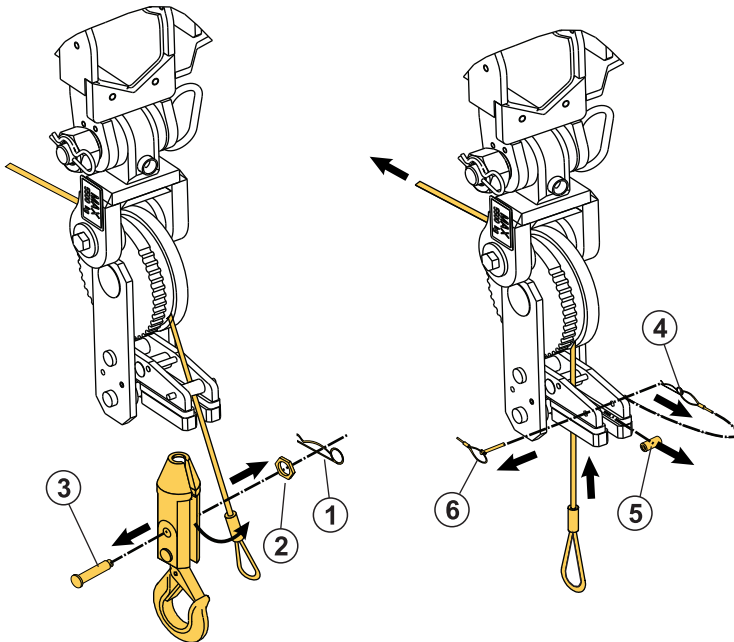

1. Remove the counterweight:
 - a. Remove the locking pin (1), the nut (2) and the pin (3).
 - b. Release the rope.
2. Remove the rope from the top roller:
 - a. Remove the locking pin (4), the roller (5) and the securing pin (6).
 - b. Pass the rope through the top roller.

3. Remove the rope from the intermediate pulleys and rope guides:
 - a. Remove necessary components (locking pins, clevis pins, rollers...) to pass the rope (1).
 - b. Install them again.

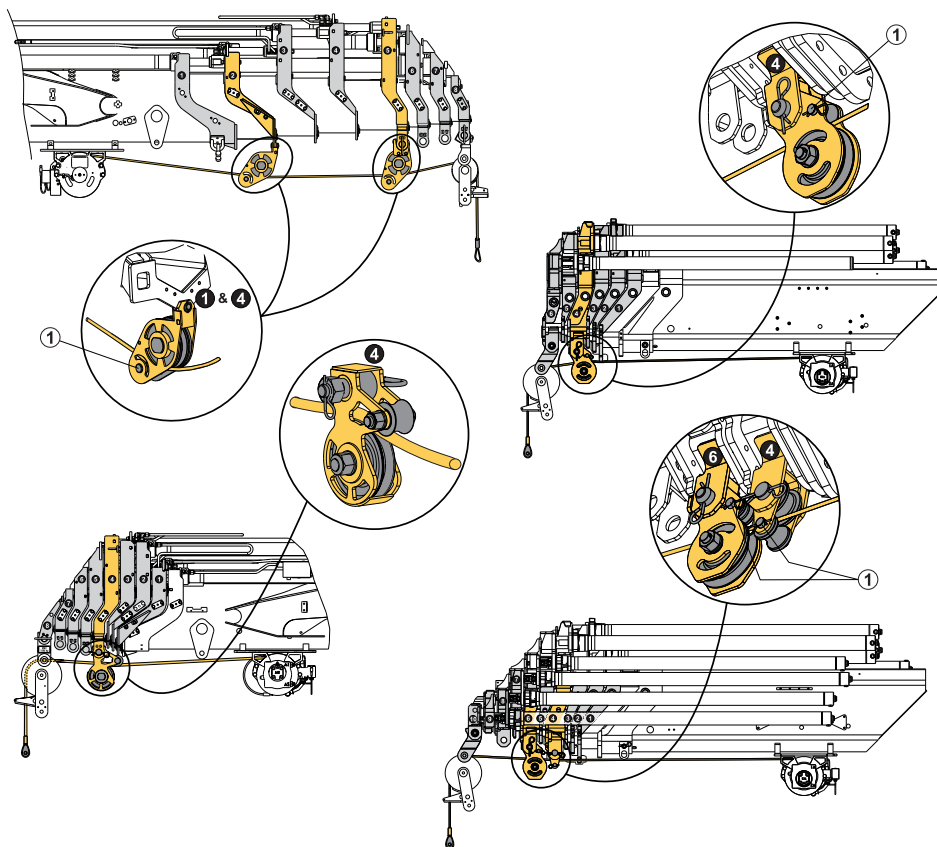

This picture shows some examples of intermediate pulleys and rope guides in different crane configuration with hoist.



NOTE

How to remove the rope depends on the crane model. The design and the number of intermediate pulleys and rope guides depend on how many extensions the crane has.



NOTE

Intermediate pulley on the 6th extension exists only for crane configurations with more than 8 extensions.



NOTE

For cranes with JIB, refer to the JIB Operator's manual for more detailed information about how to remove the rope.

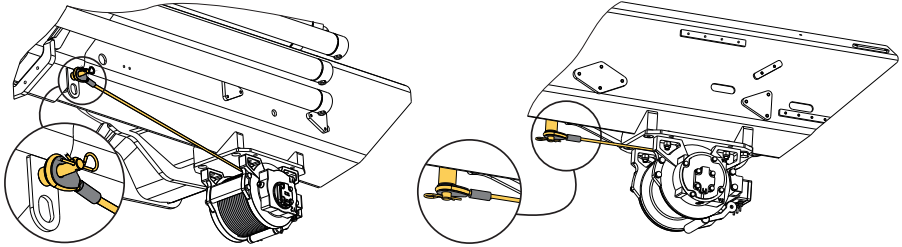
4. Put the rope end in the 2nd boom support, and then tighten the rope lightly.

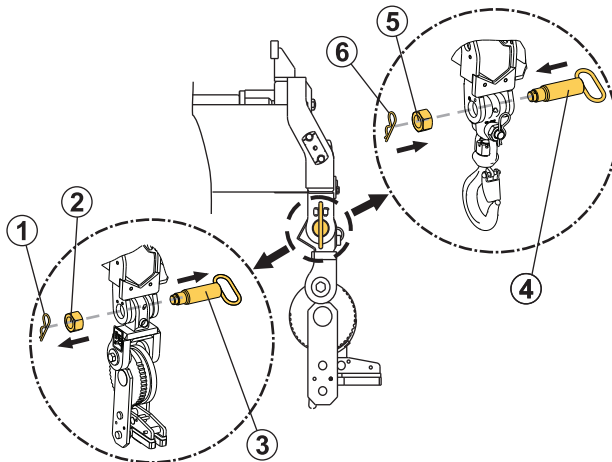

5. Remove the intermediate pulleys (if needed).
6. Remove the top roller and fit the hook:



- a. Remove the locking pins (1), the nuts (2) and the shaft (3).
- b. Put the hook and the shaft (4) in place.
- c. Tighten the nut (5).
- d. Secure with the locking pin (6).



WARNING

To prevent injury, hold the top roller firmly in your hand while you remove it.

**WARNING**

Always insert the locking pin in the shaft for all the attachments on the tip of the crane (hook, top-roller, pulleys...).

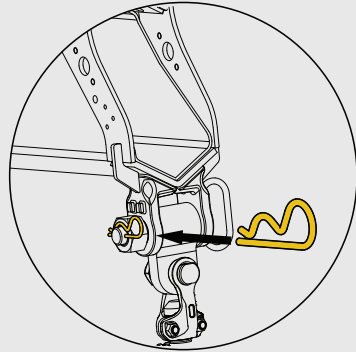
Do it in the same direction as shown in the picture.

**WARNING**

If you attach/detach equipment to/from the tip of the crane and the boom system is not in horizontal position, stay away to avoid getting caught between the boom extensions as it is normal that they can move towards each other.

7. Ending crane operation

7.1. Before folding a boom system with a hoist

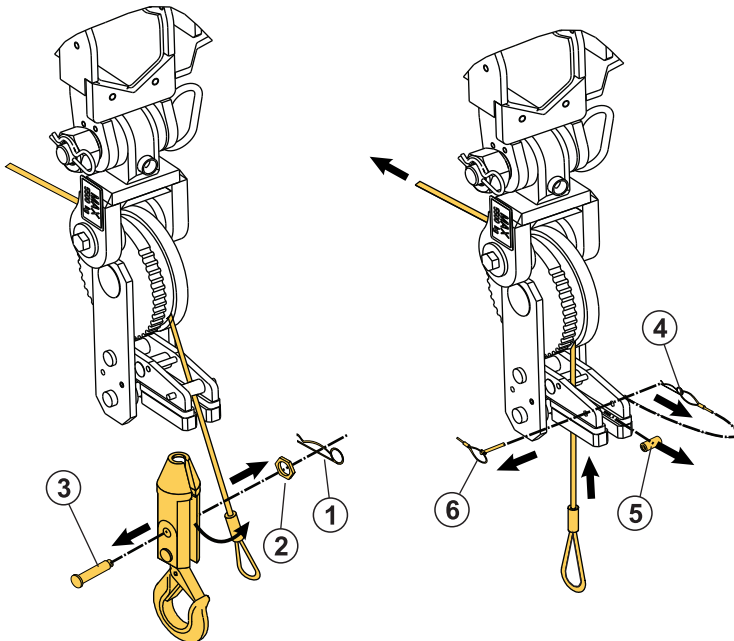

1. Remove the counterweight:

- Remove the locking pin (1), the nut (2) and the pin (3).
- Release the rope.

2. Remove the rope from the top roller:

- Remove the locking pin (4), the roller (5) and the securing pin (6).
- Pass the rope through the top roller.

3. Remove the rope from the rope guides:



NOTE

How to remove the rope depends on the crane model. The design and the number of rope guides depends on how many extensions the crane is equipped with.

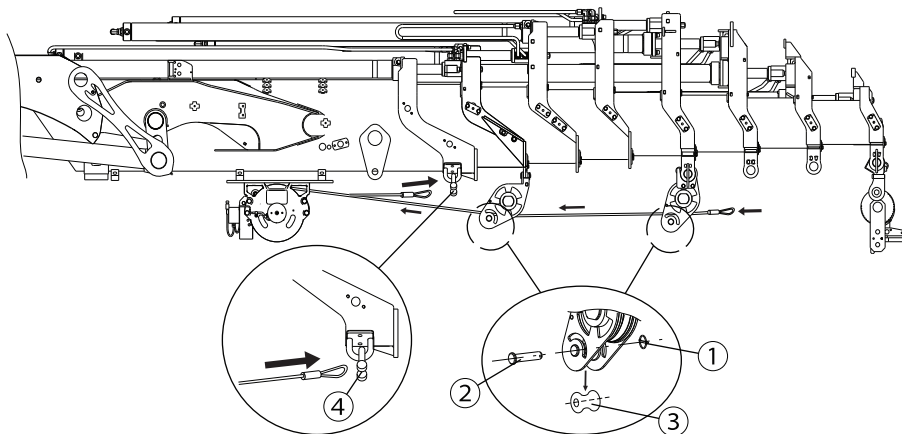

- Remove the locking pin (1), the clevis pin (2) and the wheel (3).
- Fit the rope end in the shackle (4).



NOTE

In some configurations it is necessary to detach the top roller and the rope guides. Described in "Change from hoist to hook operation".

7.2. SAF Semi Automatic Folding [option]

SAF is a feature which allows the operator to fold or unfold the boom system in one single sequence using only one lever.



Fold the boom system semi automatically



WARNING

Never use SAF with mounted tools



WARNING

For hoist:

Change from hoist to hook operation.

1. Make sure there is enough space for the crane to fold semi automatically.



DANGER

In case the situation does not allow semi automatic folding, use crane mode to put the boom system to folded position.







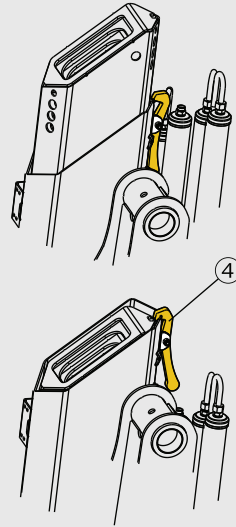

NOTE

For cranes with S-boom:

Before you select SAF menu, it is necessary to extend the boom extensions until the catcher (4) drops. Retract the extensions carefully until the catcher secures the boom. By selecting the SAF menu, you confirm that the extensions are fully retracted and that the catcher locks the boom. The SAF sequence can now be started.



2. Select menu for SAF.
3. If SAF is not configured in a separate crane menu, push button  to activate it.
4. Operate lever on the controller until the extensions are retracted:
 - XSDrive 
 - CombiDrive 
5. Confirm that the extensions are retracted on the controller:
 - XSDrive 
 - CombiDrive 
6. Continue to hold lever on the controller until the boom system is folded:
 - XSDrive 
 - CombiDrive 

**DANGER**

During this movement, the boom system will fold itself. Make sure that the boom system does not cause injury or damage, if so, release the lever immediately.

7. If SAF is not configured in a separate crane menu, push button  to deactivate it.

7.3. Operate the boom system into transport position

**WARNING**

A crane with interchangeable equipment and/or optional crane components can differ from the operations described in this section. For this reason, study the operating instructions for any interchangeable equipment and/or optional crane components carefully.

**DANGER**

- During folding of the boom system, always operate the crane manually from the position indicated in the figure.
- With remote controlled cranes, stay in a safety area while the boom system is moving.





7.3.1. Operate the boom system

1. Retract the boom extensions completely.



NOTE

If the crane is equipped with OPS, push and hold button  on the User Interface while carrying out instructions 2-5.

2. Slew the crane until the positioning arrows on the crane base and column align and  on the User Interface lights up.
3. Operate the 2nd boom against the underside of the 1st boom, as shown in the image (3). Make sure the position of the 1st boom is sufficiently high to do so.

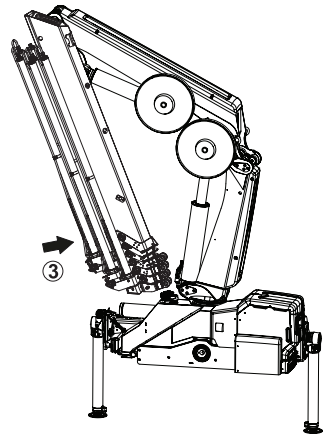

4. **Cranes with S-boom:** Start to lower the 1st boom until the 2nd boom is horizontal. Extend the extensions until the catcher (4) drops. Retract the extensions carefully to give the required parking width and the catch secures the boom. Continue to lower the boom system onto the parking support.

Other cranes: Continue to lower the boom system onto the parking support.

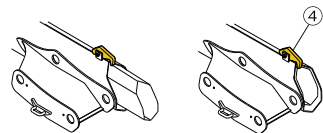

5. Lower the 1st boom until it is secured on the parking support (5).
6. Lower the 2nd boom until it is secured on the parking support (6).
7. Fold the hook.

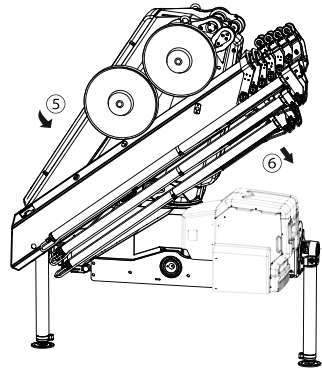

7.4. Placing the stabiliser system in the transport position



DANGER

Do not stand in the stabiliser legs, tilting area.



WARNING

Do not put your foot on the support plate.

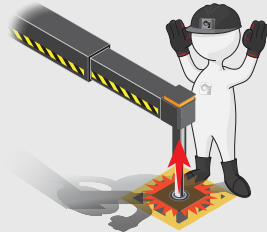

The procedure of operating the stabiliser legs differs depending on the type of stabiliser leg. Repeat the instructions for the stabiliser extension and leg on the other side of the vehicle. For auxiliary stabiliser system [option]: Repeat the process.



DANGER

Always ensure that the stabiliser legs and the stabiliser extensions are in transport position and securely locked before moving the vehicle.

Activate stabiliser operation on the User Interface by pushing button .

Non-tiltable stabiliser legs

1. Fully retract the stabiliser leg.
2. Retract the stabiliser extension completely.

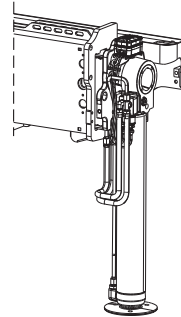

DANGER

Risk of crushing injuries.

Always keep hands away from moving parts during operation.

Manual tiltable stabiliser legs

1. Raise the stabiliser leg completely.
2. Unlock the stabiliser leg lock (2).
3. Tilt the stabiliser leg manually.
4. Lock the stabiliser leg lock (2).
5. Retract the stabiliser extension completely.

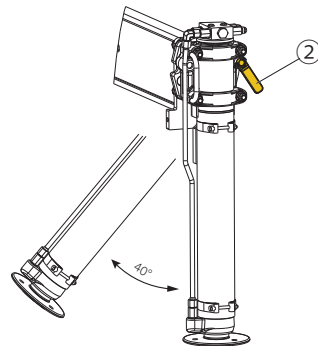

WARNING

Risk of crushing injuries

Always keep hands away from moving parts during operation

Manually tiltable stabiliser legs with gas spring support



DANGER

Risk of crushing injuries.

Always keep hands away from moving parts during operation.

1. Fully retract the stabiliser leg.
2. Place your right hand on the handle (3) while unlocking the stabiliser leg (4) with your left hand.
3. Gently pull the stabiliser leg upwards until it stops. Make sure the leg travels in a controlled movement.
4. Push the leg up until it reaches parking position.
5. Lock the stabiliser leg.
6. Retract the stabiliser extension completely.

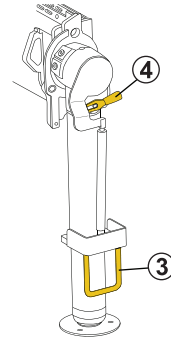

Mechanically controlled tiltable stabiliser legs

1. Raise the stabiliser leg so it is just free of the ground.
2. Unlock the leg (1).
Raise the stabiliser leg. When 200 mm remains, the leg will start to tilt upwards.
3. Lock the stabiliser leg lock (1).

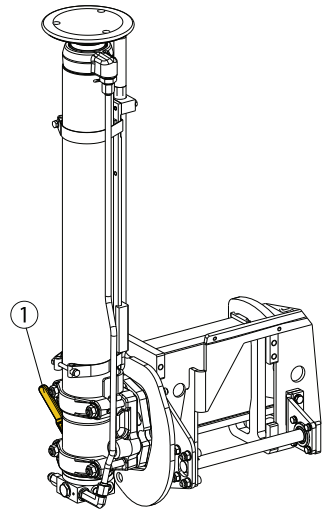

WARNING

Risk of crushing injuries. Always keep hands away from moving parts during operation.

7.4.1. Retract the stabiliser extensions

The procedure of retracting the stabiliser extensions differs depending on the type of stabiliser extensions. Repeat the instructions for the stabiliser extension on the other side of the vehicle. For auxiliary stabiliser system [option]: Repeat the process.

Manually controlled stabiliser extensions

Unlock the handle (3). Take a firm grip around handle (1), and push to retract the stabiliser extension and lock with the handle (3). Make sure the catcher (2) is securely locked.

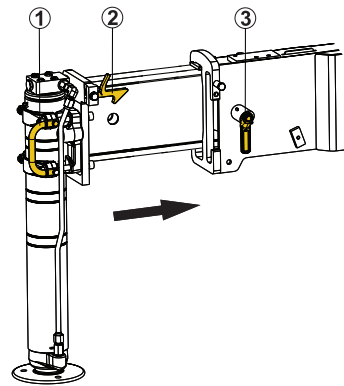

Hydraulically controlled stabiliser extensions

Retract the stabiliser extensions with the levers on the valve or the controller depending on your crane configuration. Make sure the catcher (2) [option] is securely locked.

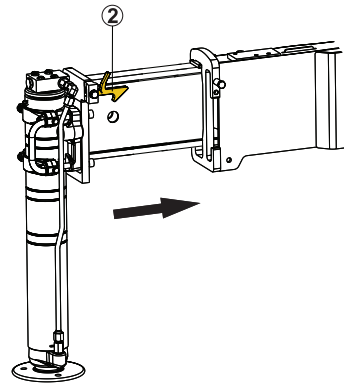

WARNING

Always ensure that the stabiliser legs and stabiliser extensions are in transport position and securely locked.

7.5. Switching off the control system

- Switch off the control system with the ON/OFF button

If you are using the remote controller:

- Push the stop button on the controller and switch off the control system.
- Disengage the PTO.

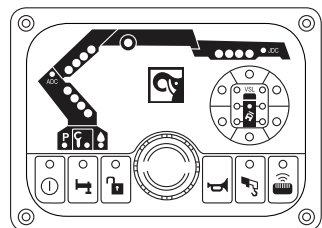

7.6. Emergency operation Valve-V80

EMERGENCY operation to bring the crane to parking position

Do like this:

On the main control valve:



DANGER

To operate the crane like this is **HIGHLY DANGEROUS** because during emergency operation all crane security is disconnected.

Always go to/contact an authorised service workshop when the seal wire has been broken.

1. Break the security seal wire and remove the cap on dump valve 1.
2. Press the dump valve button (1) to the bottom and keep it in this position while you operate the crane to parking position, using the levers on the main control valve.

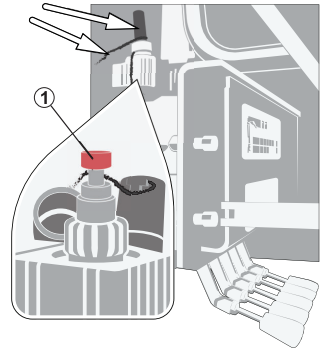

If separate stabiliser valve with manually controlled stabiliser extensions and stabiliser legs:



DANGER

To operate the crane like this is **HIGHLY DANGEROUS** because during emergency operation all crane security is disconnected.

Always go to/contact an authorised service workshop when the seal wire has been broken.

1. Break the security seal wire on dump valve 2. Located next to the stabiliser valve.
2. Turn the security screw (2) to the bottom.
3. Press the dump valve button (1) on the **main control valve**, to the bottom and keep it in this position while you operate the stabiliser extensions and stabiliser legs to parking position using the levers on the stabiliser valve.

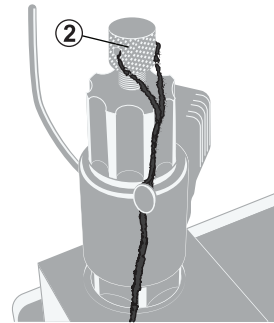

If separate stabiliser valve with remote controlled stabiliser extensions and stabiliser legs:



DANGER

To operate the crane like this is **HIGHLY DANGEROUS** because during emergency operation all crane security is disconnected.

Always go to/contact an authorised service workshop when the seal wire has been broken.

1. Break the security seal wire on dump valve 2. Located on the stabiliser valve.
2. Keep the dump valve button (1) on the main control valve and this dump valve button (3) in depressed position at the same time, while you operate the stabiliser extensions and stabiliser legs to parking position using the levers on the stabiliser valve.

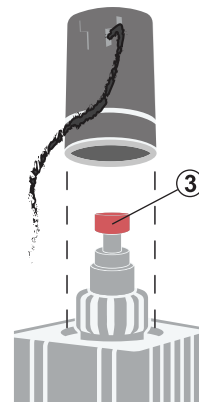

7.7. Transport warning [option]



WARNING

If you switch off the safety system when stabiliser extensions/stabiliser legs are not locked in the transport position, and/or if the 1st boom angle exceeds a certain specified angle, the indicator LEDs on the UI for both the cylinders and the hoist will flash red for a while.



The vehicle must not be moved.

- A warning, visible and audible from the driving position for transport, indicates when the crane height exceeds a predetermined maximum and when the stabiliser extensions/stabiliser legs are not locked in the transport position.
- The audible warning can be silenced by an acknowledgement button [option] or by a signal indicating that the parking brake of the vehicle is engaged.

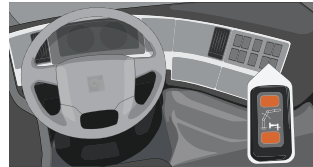

The vehicle must not be moved

1. Switch the system on and operate the crane into transport position.
2. Switch off the system. The vehicle may be moved.



DANGER

After use always put the crane into the transport position! When you have to park the boom on the load bed, or over the load, secure the boom and the lifting accessories and/or interchangeable equipment to prevent any unintentional movement of them.

8. Maintenance and Service

8.1. Service

No welding/drilling work on the crane



DANGER

- Do not do any welding work on the crane. Welding work on the crane may only be carried out by an authorised service workshop.
- Do not drill into the crane yourself. Drilling work on the crane may only be carried out by an authorised service workshop.
- Never try to reinstall the crane. Only an authorised Installer may reinstall the crane.



Leakages



DANGER

- **STAY AWAY** from oil leaks in the hydraulic system! Oil in the hydraulic system is under high pressure, can spill, be very hot and cause you injury.
- Do not replace any hydraulic hoses or lines yourself.

You can disconnect a hydraulic line or a hose only for specific operator's tasks (for example, disconnecting the interchangeable equipment).

1. Make sure that the cylinders are not at the end of stroke and minimise as much as possible the forces acting on them.
2. Switch off the system.
3. Disengage the PTO.
4. Make sure that you wear the correct personal protective equipment.
5. Move all levers in both directions to the end of the stroke to release all the pressure in the line.
6. Slowly loosen all connectors.
7. If they do not come out easily, you have remaining pressure in the line. Stop and do step 5 again.

Deal with an oil leak as follows:

1. Rest the crane on the floor or on the truck platform.
2. Switch off the control system.
3. Disengage the PTO.

Leaking coupling:

- a. Tighten the coupling with a spanner.
- b. If tightening does not help, contact an authorised service workshop.

Small leak on a line or hose:

- a. Determine if you can still park the crane.
- b. If you can, park the crane and go to an authorised service workshop.
- c. If you cannot, contact an authorised service workshop.

8.2. Warranty

The Seller only provides Warranty if the conditions specified in the "Service and Warranty Manual" are fulfilled.

Refer to the Service and Warranty Manual of your Product.

8.3. Follow the maintenance instructions!

Take the crane to an authorised service workshop for inspection and maintenance. Maintain lifting accessories and interchangeable equipment according to the supplier's instructions.

**WARNING**

- Make sure that faults in the crane are corrected immediately!
- All other faults must be corrected by personnel in an authorised service workshop!
- Carry out yourself only the service and maintenance work you have the requisite knowledge and experience for. Maintenance must be performed by qualified personnel.
- Always use personal protection devices and other safety means during the maintenance work in compliance with the regulations of the country in which you use the crane.
- All personnel must understand and comply with all warning and instructional decals attached to the body, crane and truck controls.
- Mark out the working area and make sure that there are no unauthorised persons inside.
- NEVER walk or stand under a crane or a suspended part. People may suffer fatal crushing injuries!
- When working on any part of the crane, put the "Out of Service" tags displayed clearly and wherever possible on the vehicle, and remove the ignition keys to prevent accidental operation.

**NOTE**

- Make sure that you have read the complete manual before starting the preventive maintenance. It provides detailed information about the maintenance process.
- Make sure that the manual and other documentation are in good condition, near the machine and available for anyone who needs it.

Maintenance intervals:

- Carried out by the **operator: daily and monthly inspection.**
- Carried out by an authorised service workshop:
 - **1st service:** to be made after 50 hours of use.
 - **Regular service:** to be made when one of these conditions are met:
 - 1,000 hours of use
 - 10,000 cycles
 - 365 days



NOTE

The service indicator on SPACE (if present) will light up for the 1st and regular service.



NOTE

Refer to the "Service and warranty manual" to know the actions performed by the authorised service workshop.

Long storage of the crane

If you need to store your crane for a month or longer, do this first:

1. Clean it according to the instructions in the section "Cleaning" of this manual.
2. Lubricate it according to the lubrication schedule of this manual.
3. Put the crane into transport position and disconnect the power from the vehicle battery.
4. Put grease on the exposed piston rod(s) and the external seals of the hydraulic cylinders.
5. Put a plastic cover on the crane.
6. Protect it from rain, sun and dirt as much as possible.

Cleaning

Clean your crane regularly, but:

- Always set the power off before you start.
- Do not use aggressive cleaning agents.
- If you use a high pressure water jet, make sure that:
 - Maximum temperature of the cleaning water is 60°C (140°F).
 - Maximum working pressure is 150 bar.
 - Minimum distance between the nozzle and the surface to clean is 80 cm.

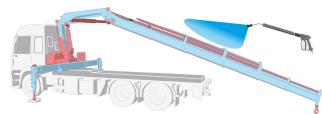

CAUTION

Never use a high pressure water jet on electronic parts, plastic components, signs, bearings, control valves, cylinders or the oil tank. Only the cranes surface may be cleaned with a high-pressure jet cleaner.

**NOTE**

Always lubricate after cleaning the crane.

**WARNING**

Keep the devices to go into the control station (handles, supports, platforms...) clean from oil, grease and dirt to prevent slipping and falling.

8.3.1. Daily inspection

Refer to the daily inspection checklist at the end of this manual to photocopy.

Presence of signs and symbols

- See chapter "Safety precautions and warnings" under section "Signs on the crane". Make sure that all the signs shown in section "Signs on the crane" are in position and in good conditions .
- Make sure that all the symbols on your crane are in good conditions.

Locking devices

- Make sure that the locking devices are undamaged and working properly.
- Make sure that the locking devices are properly locked.

Spirit Level

Make sure that the spirit level is clearly visible to the operator and works correctly.

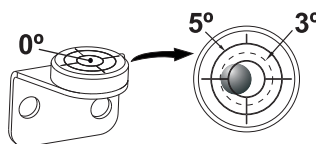
**Shafts, shaft lockings, bearings and bushings**

- Check that the shafts, shaft locking, bearings and bushings are undamaged and working properly.

Stop buttons

- Check that the Stop buttons are undamaged and working properly.

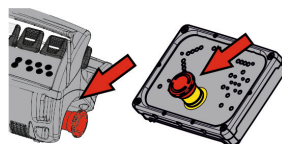
**Levers**

- Check that the levers operate smoothly.
- Check that the levers return to neutral position.

Controller

- Do a check of the controller functionality.

Crane structure

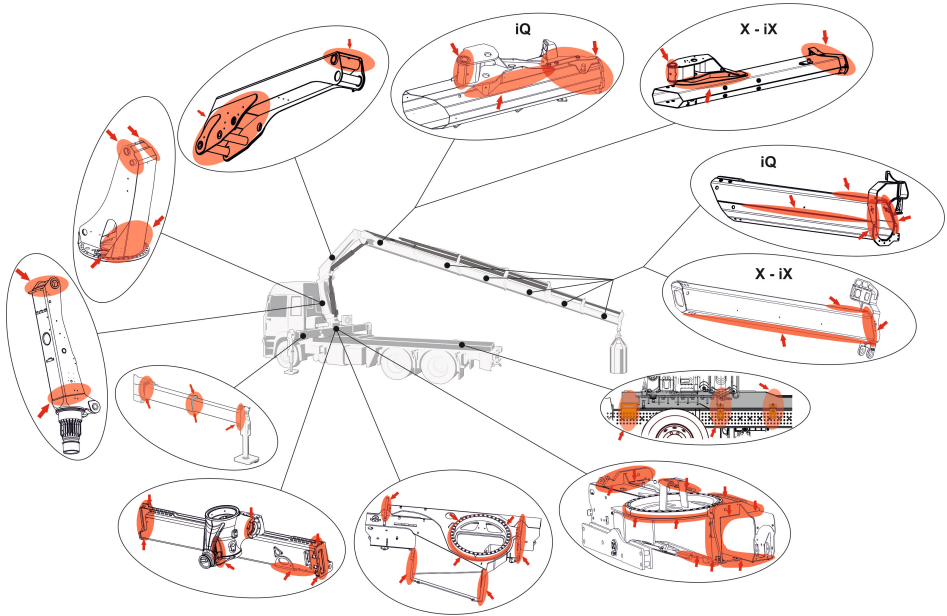

- Check for damage to the crane structure (e.g. any formation of cracks).



DANGER

In the event of damage that presents a safety risk:

- Do not use the crane.
- Have the damage repaired immediately by an authorised service workshop.

Hooks

Always keep the hook clean. Use a cloth to wipe away any dirt.

Before every working shift:

- Do an inspection of the general conditions of the Hook (1) for deformation (stretched, cracked, twisted, excessive wear...) and surface damages with significant depth (such as from chemicals or heat).
- Do an inspection of the Clevis/Link Shaft (3) for damage/deformation.
- Do an inspection of the two Spring/Roll pins (8) and (9) that are in place and properly retaining the central hook nut (6).

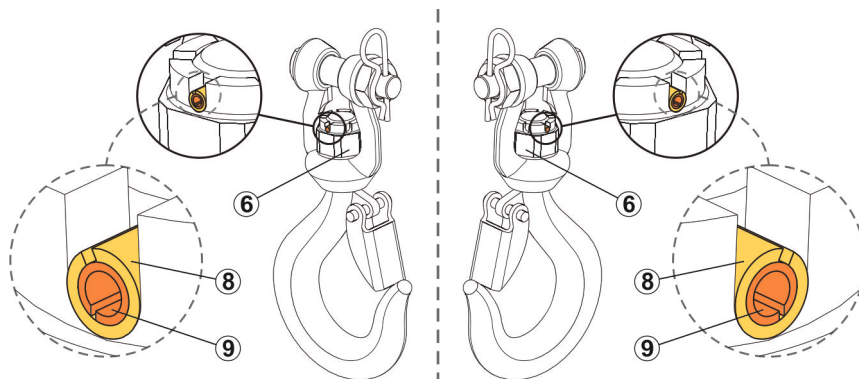
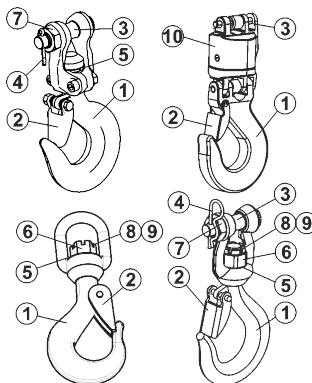

Side 1

Side 2

The two Spring/Roll pins (8) and (9) should be in place and nearly flush with the outer edge of the hook nut (6) on both sides. (See the pictures **Side 1** and **Side 2**).

- Do an inspection of the spring-loaded safety Latch (2). The Latch must close the entire throat opening.
- Do an inspection of the Clevis/Link Shaft (3), Clevis/Links Shaft nut (7) and Cotter/Safety pin (4) are in place.
- Do an inspection of the Plane bearing/Washer (5) or the Swivel (10) that is in good conditions.
- Do a general inspection for deformation and operation of the remaining items: clevis, swivels, washers, nuts, pins...
- Lubricate the hook according to the chapter "Lubrication of the hooks".



DANGER

In the event of damage or worn to prevent a safety risk:

- Do not use the hook.
- Have the damage repaired immediately by an authorised service workshop.

- Check general condition of the hook, and parts of the hook (1) for deformation and surface damages with significant depth.
- Check for damage to the hook structure (e.g. any formation of cracks).
- Check that the latch (2) closes entirely.
- Check that the shaft (3) and the locking pin (4) are in place.
- Check that the plane bearing (5) or the swivel (6) are in good conditions.



DANGER

In the event of damage or worn that prevents a safety risk:

- Do not use the hook.
- Have the damage repaired immediately by an authorised service workshop.

Lifting accessories, interchangeable equipment and optional crane components

- Check the cables, cable connections, the cable guides and the attachment points.
- Check the rope, rope connections, the rope guides and the attachment points.
- Maintain all lifting accessories, interchangeable equipment and optional crane components according to the instructions supplied with them.
- Polyamid parts as well as all bolt components have to be checked and must be replaced in case of wear and tear.

Electronic components

- Check that these are in good condition.
- Make sure that the horn works correctly.
- Do a check of the LEDs on the User Interface.

LED Test on the UI box:

1. Push the ON/OFF button for at least 2 seconds. The test is activated and all the red LEDs are illuminated. If the system is equipped with warning lights / lamp poles, all the lights will come on.
2. Release the button. After 3 sec, all the green LEDs are illuminated. The test is finished when all LEDs are off.

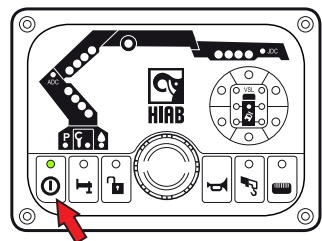

Hydraulic system and oil level in the tank

- Check that there are no leaks from the hydraulic hoses, lines and connections.
- Make sure that all security seal wires (Ex. LHV, dump valves, etc...) are not broken. Always go to/contact an authorised service workshop when the seal wire has been broken.

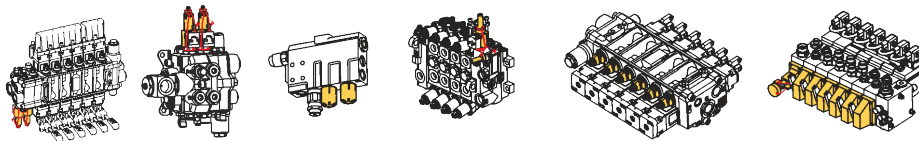

- Check oil level in the tank. If necessary, fill to correct level.



NOTE

Always place the vehicle on level ground with the crane in transport position while checking the oil.

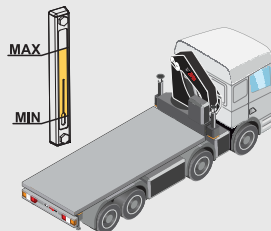

Oil level on the slewing housing

- Do a check of the oil level in the slewing housing. If necessary, fill to correct level.

Filters

- Check the filter indicator. If red, a workshop must replace the cartridge.

8.3.2. Monthly inspection and maintenance



NOTE

Refer to the monthly inspection checklist at the end of this manual to photocopy.

In addition to the daily inspection, carry out the following tasks each month:

Piston rods

- In cases where the cylinder piston rod is exposed to pollution due to the parking location, the chromed surfaces must be cleaned and oiled to prevent corrosion. This needs to be done regularly.

Pivot pins and bushes

- Inspect all the pivot pins and bushings for the crane boom and cylinders for damage, play, etc.

Bolts and screw fixings

- Check that bolt and screw fixings are tight. If not, contact an authorised service workshop

Cables and sensors

- Check that cables and sensors are in good condition.

Lubrication schedule

- Carry out the lubrication according to the instructions.

Slewing bearing / upper column bearing

- Check that the slewing bearing / upper column bearing is lubricated sufficiently.

Hydraulic system

- Check that the hydraulic pump attachment screws are tightened.
- Check if the oil in the hydraulic system needs to be changed, or have it tested by a workshop or a specialist.

Lifting accessories, interchangeable equipment and optional crane components

- Maintain all lifting accessories, interchangeable equipment and optional crane components according to the instructions supplied with them.

Hoist

- Visual control of pressure roller.

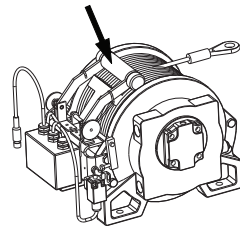

8.3.3. Annual maintenance

Take the crane, at least once a year, to an authorised service workshop for inspection and maintenance.

The workshop must carry out the following maintenance tasks at least once a year.

Hydraulic oil

- Change the hydraulic oil.



NOTE

If the workshop is equipped and the personnel prepared to do a test of the oil quality and think that the oil change is not needed, they can postpone it on their own responsibility.

Hydraulic system oil tank filler cap

- Change the filler cap.
- Replace filters.

Slewing housing

- Change oil in the slewing housing.

Hoist

- Change the gear oil in the drum.
- Inspect the braking system.

Hooks

- Replace missing or faulty parts on link assembly: shafts, safety pins and nuts.
- Replace the hook for a new one if the hook is damaged.
- Replace the latch assembly if it is damaged, missing or malfunctioning.
- **Hook 8 t and 10 t (without spring/roll pins):** replace the hook for a new one if the clevis/link or split clevis retaining nuts are missing or damaged.
- **Hook 10 t (with spring/roll pins):** replace the two spring/roll pins and the plane bearing for a new ones, at least once a year.

8.3.4. Hoist maintenance plan

Interval	Action	Operating material
Daily	Visual and acoustic check of the complete hoist system for abnormal operation and noises.	
	Visual control of the rope*	
	Visual control of leaks	
When required	Cleaning of rope	Clear water and brush
	Rope care	Wire rope spray lubricant
	Change of rope**	New rope
Monthly	Check of the fixing elements	
	Visual control of pressure roller	New pressure roller
	Gear oil control***	Gear oil SAE 80W-90
After first 100 operating hours, latest after 6 months	First change of gear oil****	Gear oil SAE 80W-90
TC: After 1000 operating hours, latest after 1 year TI: After 300 operating hours, latest after 2 years	Change of gear oil	Gear oil SAE 80W-90
Yearly	Check of the braking system	
	Complete hoist system check	

* When the rope must be discarded, (see Check rope)

** Use an original rope (see Change of rope)

*** You have to find out reason which leads to a loss of oil and the repair has to be done by experts.

**** Replace it in during the crane 1st SERVICE after 50 hours.

8.3.5. Check rope



WARNING

As ropes undergo very heavy strain and are not of permanent durability, it is important for the safety of the hoist system and like this for their operating personnel, to carry out a thorough check-up and to renew the rope in time.

After every use the rope has to be checked for damage according to the national regulations of the country of application.

Various types of damage are illustrated on the right that indicate when the rope needs to be replaced:

- Reduction of rope nominal diameter by more than 10%
- Corkscrew-type deformation
- Kinked rope
- Contracted rope
- Flattening rope
- Loop formation of wires on the rope
- Knots on the rope
- Splicing on the rope
- Basket formation on the rope
- Loose wires in the rope
- Individual wire breakages.

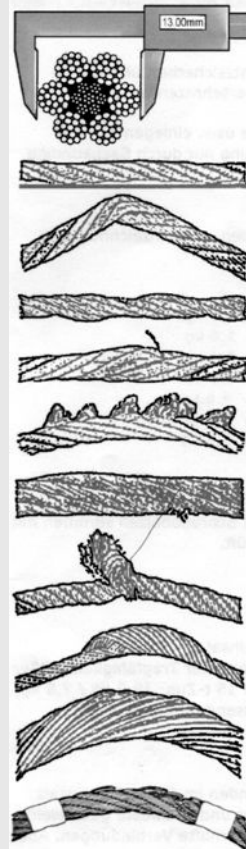



WARNING

A rope has to be discarded, when there are:

- 2 ruptures on a length of $6 \times d$, or
- 4 ruptures on a length of $30 \times d$, for ropes diameter $d(\varnothing) = 7, 8, 10$ mm, or
- 5 ruptures on a length of $30 \times d$, for ropes diameter $d(\varnothing) = 12, 14, 16$ mm.

These are the number of ruptures in the outer layers according to DIN 15020; ISO 4309.

8.3.6. Clean the hoist rope

If the rope is extremely dirty:

1. Unwind the rope until the end.
2. Clean the rope with clear water and a brush.
3. Let the rope dry.
4. After each wet cleaning, lubricate the rope.



NOTE

Do not clean the rope with steam jet blower or high pressure cleaner.

8.3.7. Course and requirements of the rope

Depending on the direction of rotation of the hoist (CW or CC) it has to be noted, from which side the rope is directed into the rope inlet.

Course of the rope CW (clockwise)

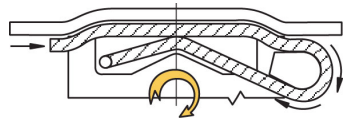

Course of the rope CC (counter clockwise)

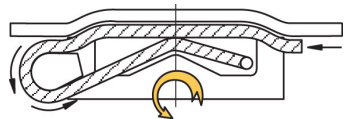

Rope requirements

For the hoists we recommend a rotating resistant rope, cross lay to the right. Always use HIAB original rope or a rope that meets Hiab's specifications.

hoist type	rope Ø (mm)	possible hoisting force (kN)		
		1st layer	4th layer	5th layer
TC1	8	11.5	9.5	-
TC2/TC2L	10	24	18	-
TC3	14 (12)	39 (39)	30 (xx)	-
TC5	14 (16)	54 (54)	43 (xx)	-
TI1	8	12.5	10	9.5
TI2	10	26	20	19
TI2L	10	26	20	-
TI4	13	45	35	33
TI5	-	-	-	-



NOTE

When choosing a rope under all circumstances the standards of the country of the user have to be noted.

This applies especially for the permitted loading of the rope.

8.3.8. Change of rope



NOTE

Always use Hiab original rope or a rope that meets supplier's specifications.



WARNING

- Incorrect installation of the rope may allow the load to drop down, causing material damage, severe injury or even death.
- Always wear protective gloves when handling a hoist rope.
- Carry out the procedure with two persons.
- During hoist movements, keep at least 2 m distance from the hoist drum.
- Make sure to keep your fingers and clothing out of the way of the moving hoist parts.

Old rope has to be discarded

1. Activate the emergency stop button on your crane.
2. Keep the roller, which is connected with the rope end switch, disengaged.

- a. Insert a screwdriver in the lower hole behind the hoist drum.
- b. Push the screwdriver to the right, and the roller will be moved forward.
- c. Press in a pin or a new screwdriver to keep the roller in place.
- d. Keep the hoist end rope switch in override position.

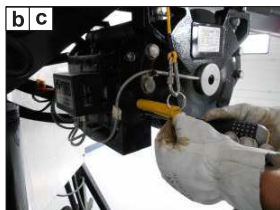

- 3.
4. Guide the rope out of the rope guide/s and top-roller.
5. Release the emergency stop button on your crane.
6. Unwind the rope **without load**, until the last 3 or 5 safety windings are left.
 - Wind the old rope around an empty drum.
 - Or place it on the floor in the shape of an eight figure (a left turn followed by a right turn, etc.) to prevent loops and tangling.
7. When there are 3 or 5 windings remaining on the hoist drum, turn the hoist drum slowly until you have access to the rope pocket (1).
8. Activate the emergency stop button on your crane.
9. Detach the rope wedge (2) in the direction of the arrow. Refer to the sign placed on the hoist.
10. Pull out the old rope from the rope inlet (3) and remove it from the drum.
11. Discard the rope.

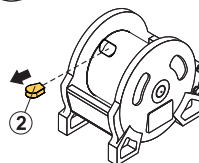
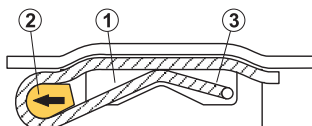

Install a new rope

1. Prepare the positioning of the rope to ensure that it does not twist or form loops during the installation.
2. Make sure that the hoist end rope switch keeps in override position.
3. Activate the emergency stop button on your crane.
4. Guide the smooth end of the new rope through the top-roller and the rope guide/s.
5. Guide the rope end through the inlet (3). Insert rope around rope wedge (2) as indicated and insert both in the cast-in pocket (1) in the direction of the arrow.

Make sure that the rope with rope wedge are perfectly clamped in the rope pocket.
6. Release the emergency stop button on your crane.
7. Spool on the rope. Keep it tensioned as much as possible, to ensure that the rope is spooled flat and tight on the drum.
 - The first layer should follow the grooves on the drum. The following layers are wound similarly.

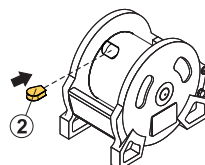
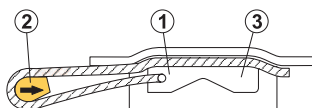

- Constantly verify visually that the rope is wound correctly on the drum.
 - Stop and correct if needed.
8. Activate the emergency stop button on your crane.
 9. Remove the pin or the screwdriver from the roller to keep the hoist end rope switch active again.
 10. Release the emergency stop button on your crane.
 11. After the replacement, unwind the rope completely (with counterweight) and wind it again.
 - In order to achieve a high spooling quality and durability the rope always has to be spooled on with a minimum hook load according to the following table.

Hoist type	Minimum load
TC1 / TI1	40 - 80 kg
TC2 / TC2L / TI2 / TI2L	70 - 140 kg
TC3 / TI4	150 - 300 kg
TC5 / TI5	200 - 400 kg
As a basic rule we recommend ~ 5% of the hoist load capacity.	

- Make sure that the rope spools up on the hoist drum and that the end rope switch are working properly.

8.3.9. Maintenance and monitoring of rope end

Inspection of the wear pad



CAUTION

In order to prevent possible damage to the rope, the wear pad (1) must be replaced, before metal of the clamp (2) or the screws (3) become visible.

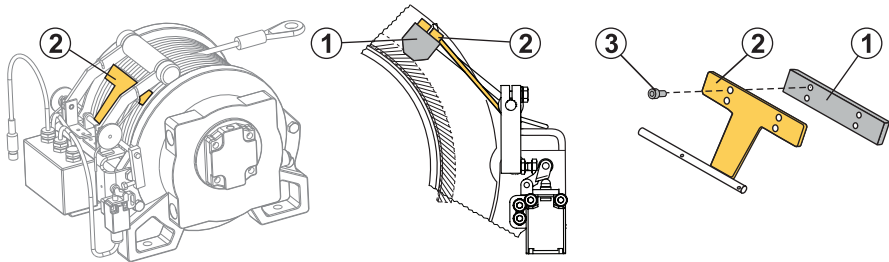

It is recommended to inspect the wear pad at least every 6 months.

Under following conditions it is necessary to inspect wearing parts more often than the normal maintenance inspection:

- intensive use
- mainly operation on the top rope layer
- rough environmental conditions (sand, dust, etc.)

Changing of the wear pad

Remove the screws (3) and the wear pad (1) from the clamp (2). Fit the new wear pad and secure with the screws (3).

8.4. Lubrication

General greasing of the cranes

Incorrect or insufficient lubrication of a crane is the number one cause of premature failure.



WARNING

Before and after a long stop of the crane, lubrication is absolutely necessary. This is especially important after a winter shutdown.



WARNING

Follow the lubrication schedule exactly. If you do not do so, you can cause serious damage to the crane, interchangeable equipment and/or optional crane component.

Procedure:

1. Shut down the crane.
2. Make sure that all the lubrication points are clean before lubricating. Dirt can damage the parts.
3. Lubricate all points in each section.
4. Operate the crane through the full cycle for each section. Moving the lubricated parts is really important to get the full and correct lubrication of all moving components.
5. Shut down the crane and repeat the lubrication.
6. Lubrication is finished when the grease spills out from the ends. Clean the excess grease.

**WARNING**

Personnel should never attempt to work on a crane that is moving. Serious injury or death will occur if you try to work on an activated/moving crane.

**CAUTION**

When you use pressure grease pumps, open the plastic safety guard of the nipple and close it at the end.

Greases

Use lithium-based grease containing EP additives (consistencies 2 and 3 are recommended, depending on the climate).

**CAUTION**

Do NOT grease with graphite or molybdenum-disulphide additives.

Recommended greases:



BP LS EP 2, ESSO UNIWAY EP2 N, AGIP GR MU/EP3, NYNÄS UNIFETT EP.

Alternative:

Use a Teflon grease spray to lubricate the extensions and mobile parts.

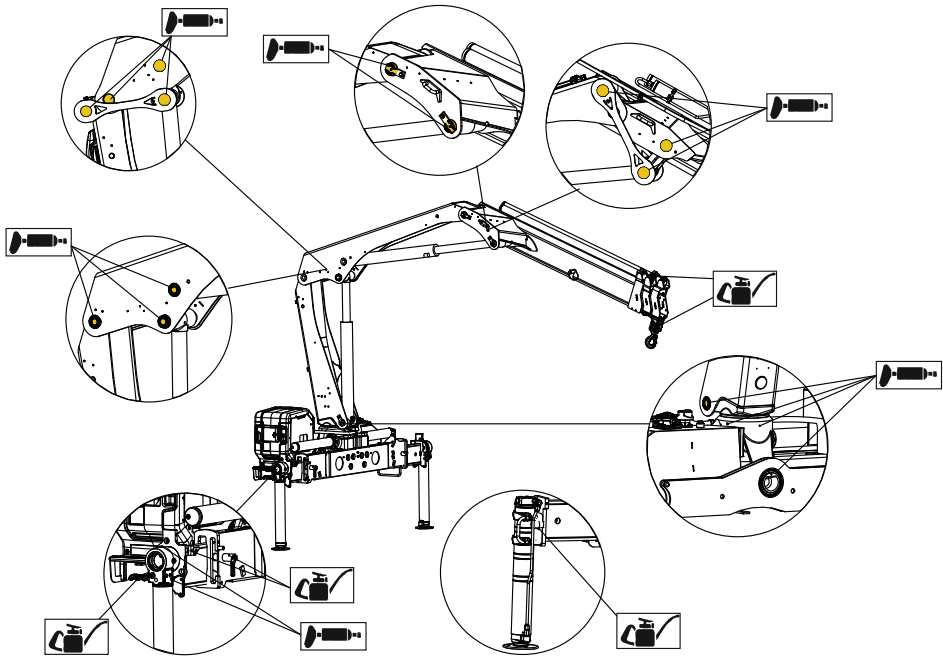
8.4.1. Lubrication schedule



	<p>Lubricate after every 16 hours of use.</p>
	<p>Lubricate after every 50 hours of use.</p>

8.4.2. Greasing the upper column bearing and three-point bridge



DANGER

The upper column bearing must be greased while the crane is slewed.



NOTE

The lubrication points can be fitted differently than showed in the image.

Grease through the nipples in the greasing manifold, located on the crane base, according to the greasing signs. If the manifold does not exist, grease directly through the nipples, located on the upper column bearing.

If you are greasing the upper column bearing without help:

1. Grease the upper bearing with a little grease.
2. Slew the crane a little.
3. Grease it again and repeat until the column has completed one turn.

If you are greasing the upper column bearing with help:

One person greases the upper column bearing, while another carefully slews the crane.

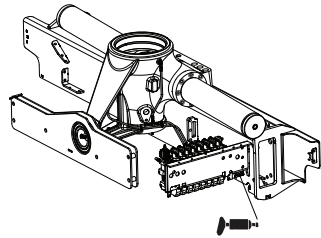

DANGER

Be very careful that the person greasing the bearing does not come into contact or get crushed by the crane!

Greases: Use lithium-based grease containing EP additives (consistencies 2 and 3 are recommended, depending on the climate).

Do not use grease with graphite or molybdenum-disulphide additives.

8.4.3. Lubrication of the column bearings

(Cranes up to X-072)



DANGER

The column bearings must be lubricated while the crane is slewed. If one person lubricates the column bearings, while another is slewing the crane: Take care that the person lubricating the bearings does not come into contact or get crushed by the crane!

If you are lubricating the column bearing without help:

- Lubricate the bearings with a little grease.
- Slew the crane a little.
- Again lubricate with a little grease. Repeat, until the column has been slewed round completely.

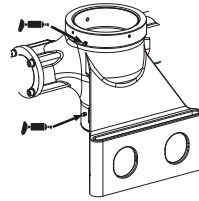
8.4.4. Lubrication of the hooks
Hooks with plane bearing

If the hook cannot rotate easily without load:

- Put grease on the plane bearing surfaces (1).
- Use a heavy duty penetrating spray grease, type "ZEP 2000" or equivalent quality.

Hooks with swivel

Put grease if the swivel cannot rotate easily:

1. Remove the screw (2) and mount a grease nipple.
 2. Add grease until grease appears between house (3) and shank (4).
 3. Mount the screw (2).
- Use a bearing grease, type "Texaco Multifak EP 2" or equivalent quality.

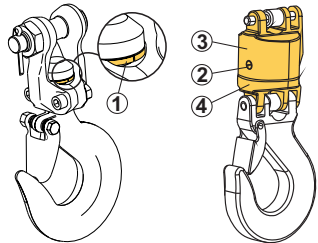

8.4.5. Lubrication of intermediate pulleys, rope guides and top roller

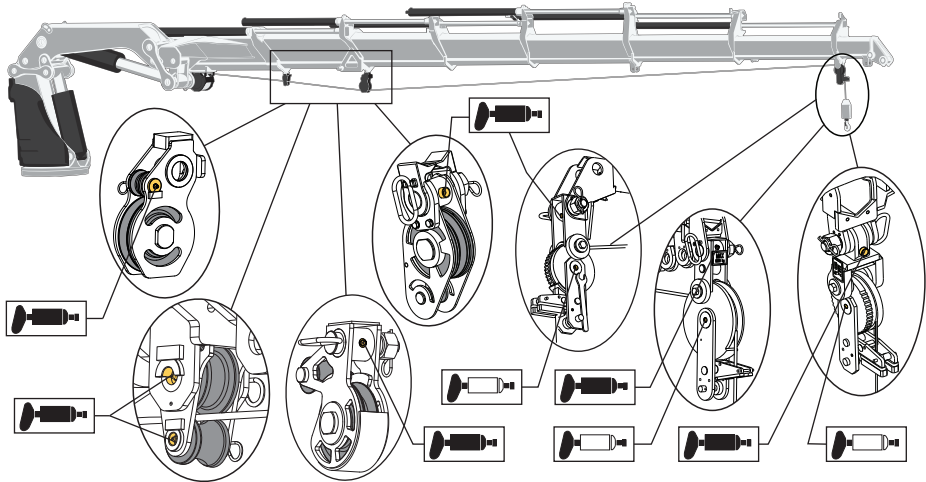

	Lubricate after every 16 hours of use.
	Lubricate every 3 months. If the hoist is used less frequently than 3 months, lubricate before every use.

8.5. Checking and topping up oil levels

8.5.1. Slewing housing: checking the oil level and topping up

Recommended oils for topping up oil in the slewing housing

Use a hypoid oil, type API GL-5, SAE J2360 (Formerly MIL-L-2105), viscosity SAE-80W-90, cleanliness NAS 1638:8. For example: "ENI ROTRA MP 80W-90", "SHELL SPIRAX S2 A 80W/90" or equivalent quality.



CAUTION

The oil used for filling must be clean. Do not mix different oils (a mixture will change the oil properties).

Oil level checking

Measuring stick or level glass

- Check if the oil level on the measuring stick (1) or on the level glass (2) is between the maximum and minimum levels.

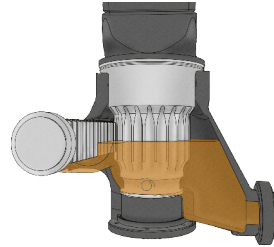

Oil filling procedure (top up procedure)

Measuring stick or level glass

1. If the oil level is below the minimum level, remove the measuring stick/plug (1).
2. Top up through the filling hole (1) with hypoid gear oil.
3. Make sure that the oil level is between the maximum and minimum levels on the measuring stick (1) or on the level glass (2).

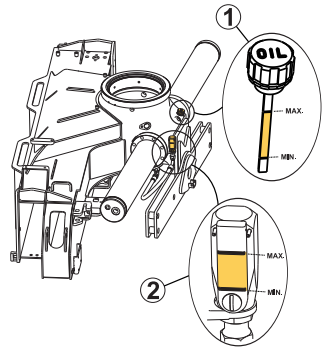

8.5.2. Checking of the oil level of the tank

1. Place the crane and stabiliser legs in the transport position.
2. Place the vehicle on level ground.
3. Check the oil level in the tank.
4. If the oil level is too low, top up with hydraulic oil.

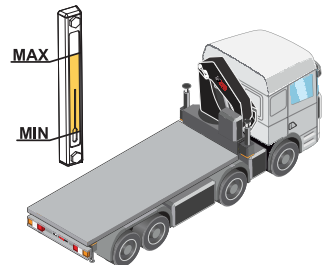

Oil filling / Top up

1. Make sure that the required equipment to fill the tank is fully clean.
2. Put the crane in the parked position.
3. Clean the area around the oil filler cap.
4. Fill with oil up to the max level indicator.

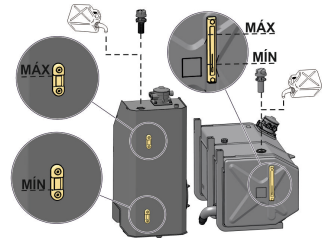

CAUTION

- Never fill the tank completely, because during operation, the volume of the oil could expand as the temperature increases.
- Never use recycled oil!

Filling the oil tank with hydraulic oil



CAUTION

The oil used for filling must be clean. Do not mix different oils (a mixture will change the oil properties).

Hydraulic oils must have been dealt with according to cleanliness requirements ISO 4406: -/16/13.



The hydraulic oil approved for our products must comply with one of the following standards or equivalents:

- ISO 11158 HV
- DIN 51524 part 3 HVLP
- ISO 6743/4 L-HV

Verify with the supplier that the quality and performance of the hydraulic oil comply with the previous standards.

When changing from mineral oil to a non-polluting synthetic oil, or when changing to biodegradable oil, contact an authorised service workshop.

Recommended hydraulic oils

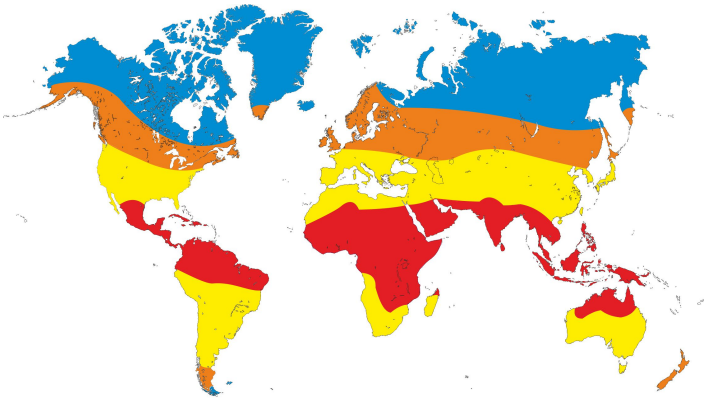
	ISO VG 32	ISO VG 46	ISO VG 68
Examples	Tellus S2 V32 Super 32 Hydrol L-HV 32	Shell TELLUS T 46 Texaco RANDO HDZ46 Agip ARNICA 46	Mobil SHC 526
Where to use them			
			

Viscosity of oil

The viscosity of the oil is important to achieve high efficiency of the hydraulic system.

The naming of the oil in the table below: 32, 46 or 68 tells the viscosity of that oil at 40°C (104°F) (reference temperature).

Viscosity of oil at 40°C (104°F)	Temperature range
32	-25°C to 75°C (-13°F to 167°F)
46	-15°C to 90°C (5°F to 194°F)
68	-5°C to 90°C (23°F to 194°F)

The recommended viscosity during normal working conditions is between 16 and 40cSt.

Hiab strongly recommends an oil working temperature below 70 °C (158 °F). If necessary consider an oil cooler or heater.



NOTE

If you need to work at a temperature below -25 °C (-13 °F), contact an authorised service workshop.

Environmentally friendly oil

The environmentally friendly oils recommended are ester-based synthetic hydraulic fluids (synthetic ester).

CAUTION

Vegetable oils do not meet Hiab requirements and must not be used.

After filling the tank

1. Operate each crane function to its end positions.
2. Operate the crane to parked position.
3. Check and top up the oil tank to max level on the tank gauge.
4. Bleed the air from the hydraulic system.

8.5.3. Oil level checking
Recommended oil:

Use a hypoid oil, type API GL-5, SAE J2360 (Formerly MIL-L-2105), viscosity SAE-80W-90, cleanliness NAS 1638:8.

For example: "ENI ROTRA MP 80W-90", "SHELL SPIRAX S2 A 80W/90" or equivalent quality.

CAUTION

The oil used for filling must be clean. Do not mix different oils. In general, a mixture will change the oil properties.

Supplier recommendation:

Carry out gear oil control every 3 months.

However, if an oil leakage occurs or a gear repair is necessary, top up the hoist gear with oil.

Procedure

1. The hoist must be in horizontal position.
2. Stop the crane and switch off.
3. Remove plate (1).
4. Remove screw (2) and check if oil is leaking out.
 - a. If the oil flows from the opening, proceed as described in the next step.
 - b. If the oil is too low, proceed as described under "Oil filling / Top up or oil replacement procedures".
5. Tighten screw (2) when oil level is OK.
6. Mount plate (1) again.

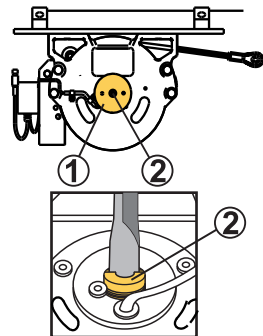
8.5.4. Oil filling, top up and replacement procedures
Supplier recommendation:



NOTE

The replacement of the oil must be done by an authorised service workshop according to:

- The first oil change must be done after the initial 100 hoist operating hours, at the latest after 6 months.
- For **TC series**: change of gear oil after 1000 operating hours, at the latest 1 year.
- For the **TI series**: change of gear oil every 300 operating hours, no longer than 2 years.

Drain off the oil

1. Make sure that the gear oil is warm. If necessary, heat up by reeling in and out a number of times.
2. Reel out the rope so much that you get access to opening (3).
3. Place an oil container under the drum and remove screw (3).
4. Turn the drum until the opening is at the underside.
5. Drain all oil. Discard according to local procedures.

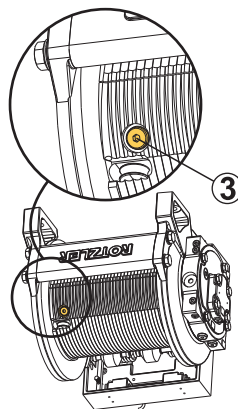

Oil filling, top up

1. Remove plate (1) and screw (2).
2. Turn the drum so opening (3) is above the centre line.
3. Fill the drum with oil until it starts leaking out of the opening at the side (content approx 1.2 - 1.4 liters).
4. Mount both screws and the plate again.
5. Reel in the rope.

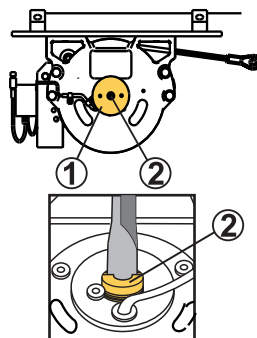

Gear oil quantity in the drum:

TC1 = 0.5 l	TC2 = 0.6* l	TC2L = 1.25* l	TC3 = 2.3 l	TC5 = 3.5 l
TI1 = 0.5 l	TI2 = 0.7 l	TI2L = 1.4 l	TI4 = 2.5 l	TI5 = 3.5 l
* +0.1 l if hoist has No. 400000...xxx				

TIP

These filling amount can be less than the indicated filling amount, since oil remains in the hoist.

8.6. Replacement of filters

Filter cartridges must be replaced by an authorised service workshop:

- After the first 50 hours operation
- Then after every 1000 hours operation
- Or at least once a year.

How do you verify if the filter needs a replacement?

The high pressure filter is on the crane base, connected to the pressure line from the pump. It has an indicator (1) that turns red when the replacement is needed.

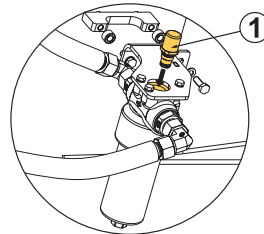

The return oil filter is on the oil tank, and can have a clogging indicator. This indicator turns red when needed. In all other cases (if the filter time is expired or without clogging indicator), you must follow the general recommendations for its replacement.

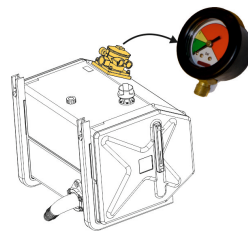

There are other filters on your crane (the pressure-reducer filter (1) on remote-controlled cranes, and the breathing filter (2) on the oil tank). These filters have no indicator and you must follow the general recommendations for their replacement.

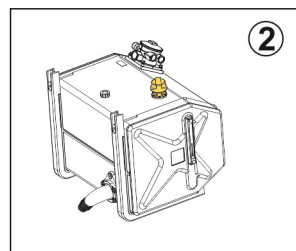
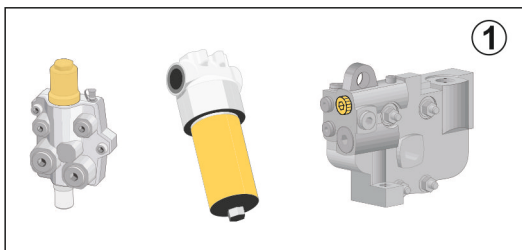

8.7. Bleeding air from the hydraulic system

Bleed the air from the hydraulic system:

- after changing the hydraulic oil
- after working on the hydraulic system
- if your crane works slowly or jerkily
- if your crane has not been used for a long time



WARNING

Air in the hydraulic system can lead to faults and damage

To bleed the air from the hydraulic system, proceed as follows:

1. Slowly extend and retract each stabiliser extension to its end position at least two times.
2. Slowly extend and retract each stabiliser leg to its end position at least two times.
3. Set stabiliser system in working position and operate the crane out of parked position.
4. Slew the crane slowly.
 - If your crane has a rack-and-pinion slewing system, slew the crane in each direction to the slewing stop at least twice.
 - If your crane has a continuous slewing system, slew at least two complete rotations.
5. Slowly raise and lower the 1st and the 2nd boom to its end position at least twice.
6. If the crane is equipped with JIB, slowly raise and lower the JIB at least twice with main boom system pointing downwards and upwards.
7. Slowly extend and retract the boom extensions to their end position at least twice.
 - a. If your crane is equipped with JIB, extend and retract the 2nd boom extensions with the JIB pointing almost vertically upwards and downwards.
 - b. Slowly extend and retract the JIB extensions to their end position at least twice.
8. Slowly operate each hydraulically operated interchangeable equipment and/or optional crane components to their end position at least two times.



CAUTION

Do not keep the lever engaged at the end position of each movement.

9. Check the oil level in the tank and top up if necessary.

8.8. Troubleshooting

8.8.1. Main fuses

If the microprocessor detects a fault, this must be rectified immediately.

Fault	Probable cause	Action
<p>The control system does not work at all.</p> <p>The indicator light next to ON/OFF button on the User Interface is not lit, even if you push ON/OFF.</p>	Defective fuses.	<ol style="list-style-type: none"> Replace faulty fuses in the: <ul style="list-style-type: none"> - vehicle - standard box - relay box (See Description, Components, Fuse, Location) Check all the cable connections.

Description	Components	Fuse	Location
System main fuse	Relay Box, Standard Box, Oil Cooler	40 A	Located on the vehicle where the crane is mounted.
Fuse for all components controlled by the relay box.	Hydraulic main control valve, stabiliser leg warning lamp, Remote control, User Interface, MUX box. Truck warning interface, Work lights.	15 A	Located inside the relay box (1).
Fuse for all components connected to the standard box.	Hydraulic main control valve, stabiliser leg warning lamp, User Interface, MUX box. Truck warning interface.	10 A	Located inside the standard box (2).

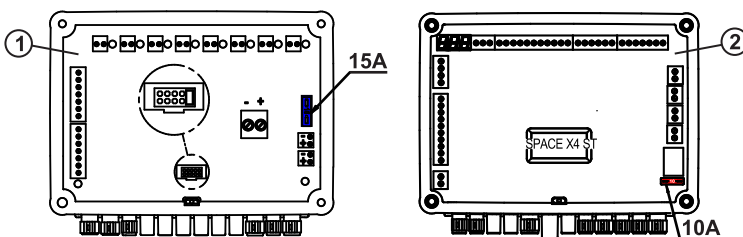

8.8.2. Faults on the crane

Faults in the crane must be rectified immediately.





DANGER

- Only correct yourself the faults that according to the table you may rectify.
- Follow the instructions exactly!
- All other faults must be corrected by personnel in an authorised service workshop!

Fault	Probable cause	Action
Control system will not start.	Parking brake on the truck is not engaged.	Engage parking brake on the truck.
The hydraulic pump makes a noise. Warning! Stop using the crane immediately!	Oil tank filler breather is clogged.	Clear the blockage or replace the entire filler cap.
	Oil level in the tank is too low.	Top up the oil tank and bleed the hydraulic system.
	Hydraulic pump is faulty.	Go to an authorised service workshop.
Leak on hydraulic system: leaking coupling, hose or line. Danger! Keep away from any oil leak.		1. Push in the Stop button [if fitted].
		2. Disengage the PTO.
		3. Contact an authorised service workshop.
Stabiliser extensions do not slide out.	Stabiliser extensions are still locked.	Unlock the stabiliser extensions.
	Hydraulic fault.	Go to an authorised service workshop.
The stabiliser extensions do not slide out/in. (Chain-driven stabiliser system)	Incorrect chain tension.	Contact an authorised service workshop.
The stabiliser leg cylinder cannot keep the truck load and it goes inwards.	Check valve damaged.	Go to an authorised service workshop.
	Cylinder internal leakage.	Go to an authorised service workshop.
	Soft ground surface.	Set again the stabiliser led onto the ground or add an extra support plate between the cylinder and ground.
Slewing support cylinders do not turn	Three-way valve failure.	Go to an authorised service workshop.
Irregular slewing movements and unusual noises in cranes with rack and pinion slewing system.	Insufficient oil in the hydraulic system.	Top up the oil tank.

Fault	Probable cause	Action
	Insufficient oil in the slewing housing.	Top up the oil in the slewing housing to the required level.
	The upper slewing bearing is not properly lubricated.	Lubricate the bearing.
	The bearings in the slewing housing are damaged.	Go to an authorised service workshop.
Irregular slewing movements and unusual noises in cranes with continuous slewing system.	Insufficient oil in the hydraulic system.	Top up the oil tank.
	Insufficient oil in the gearbox.	Top up the oil in the gearbox to the required level.
	Bearing assemblies and pinion are not properly lubricated.	Lubricate the bearing while slewing.
	Bearing assemblies or pinion is damaged.	Go to an authorised service workshop.
One function of the controller does not work.	One lever of the controller was not in neutral at start up.	1. Push in the Stop button.
		2. Make sure that all levers are in neutral.
		3. Release the Stop button.
Crane does not react to controls. Indicator lamps light up on the User Interface.	The crane is in an OLP situation.	Perform movements to reduce the load moment. If necessary, release OLP.
Crane does not work properly: One or more crane functions do not work, or not properly. Lifting capacity is much less than normal. Operating speed is significantly reduced. The service lamp is lit.	The system has detected a fault.	Contact an authorised service workshop.
Crane performance when operating it with the controller is unsatisfactory.	The pressure-reducer filter is clogged.	Replace the pressure-reducer filter.
Boom system cannot keep the load height, and it goes down by itself.	Load holding valves on the 1st boom or 2nd boom damaged.	Go to an authorised service workshop.

Fault	Probable cause	Action
	Cylinder internal leakage.	Go to an authorised service workshop.
Boom extension cylinders do not follow the sequence.	Cylinder internal leakage.	Go to an authorised service workshop.
Boom extensions shake during extending/retracting function.	Cylinder internal leakage.	Go to an authorised service workshop.
	Sequence screw in cylinder head loose.	Tight the screw in the right position.
Boom extensions cannot keep the load height and they move out by themselves.	Extension load holding valve damaged.	Go to an authorised service workshop.
	Cylinder internal leakage.	Go to an authorised service workshop.
Interchangeable equipment does not work properly (JIB, grapple, rotator, etc.)	Connectors not properly connected.	Reconnect the interchangeable equipment according to the instructions.
	Other defect.	Go to an authorised service workshop.
(Option) when using the SAF feature: The sequence for unfolding/folding the boom system stops and does not finish.	The system has detected an internal error with the feature.	Use crane mode to fold/unfold the boom system.
(Option) when using the SAF feature: Crane with boom extensions fully retracted does not continue with the folding sequence.	The feature needs the confirmation from the operator that the boom extensions are fully retracted.	Push the button/lever  or  on the controller to confirm that the boom extensions are fully retracted.

8.8.3. Faults in the hoist

Faults in the hoist must be rectified immediately.



DANGER

- Only correct yourself the faults that according to the table you may rectify.
- Follow the instructions exactly!
- All other faults may be dealt with only by personnel in an authorised service workshop!

Symptom	Probable cause	Action
Hoist will not hoist/pull rated load.	Inadequate hydraulic system supply pressure.	Verify hydraulic system supply pressure and correct as required.
	Damaged hoist motor.	Go to an authorised service workshop to have the motor replaced.
	Hoist center line is distorted due to uneven mounting surface.	Contact an authorised service workshop.
	Binding load carrying sheaves.	Inspect and repair or lubricate sheaves as required.
Hoist will not turn at rated speed.	Inadequate hydraulic system supply volume.	Verify hydraulic system supply volume and correct as required.
	Damaged hoist motor.	Go to an authorised service workshop to have the motor replaced.
	Hoist center line is distorted due to uneven mounting surface.	Contact an authorised service workshop.
	Binding load carrying sheaves.	Inspect and repair or lubricate sheaves as required.
Hoist will not hold the load.	The rope is wound onto the drum in the wrong direction.	Spool rope according to section in this manual: Course and requirements of the rope.
	Clutch assembly is damaged.	Verify and replace as required.
	Brake Friction or Separator Plates are worn or damaged.	Verify and replace as required.

8.8.4. Display [option]

The display has three menu items: *Error codes*, *Timers & Counters* and *VSL*. These items are shown on the screen when the display is first engaged. To be able to select an item push the menu toggle button or the OK button. In the bottom left of the screen the name of the item currently highlighted is shown.

Buttons

- (1) Push to go back to main menu
- (2) Push to go back one step
- (3) Push to toggle between menu items
- (4) Push to select item

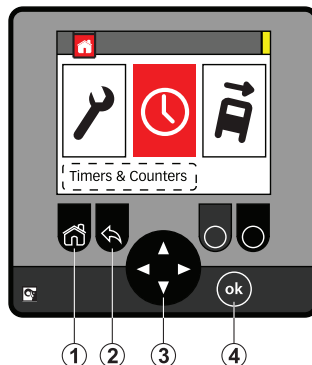

Menu items

Error codes

If item *Error codes* is selected and there are errors present in the system the screen will show a three-digit number for each fault in the system.

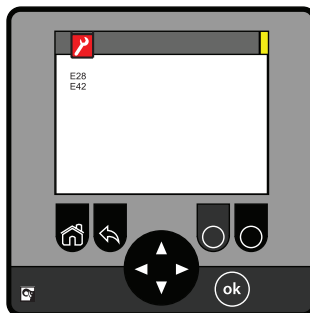

Timers & Counters

When item is selected information is shown about:

- Total time - Number of hours that the crane has been engaged
- Use time – Number of hours that dump valve has been active
- Lift count – Number of lifts made
- Time to service – Number of hours with the crane engaged until next service
- Use time to next service – Number of hours with dump valve active until next service
- Lifts to service – Number of lifts until next service



VSL

If you select this symbol, the truck VSL diagram shows six sectors surrounding the crane, and in each sector there is a percentage. A percentage of 90 indicates that the maximum pressure available in the 1st boom cylinder is reduced to 90% in this sector to guarantee full stability. The different sectors are marked with colors: green, yellow, grey or red. The green indicates the highest percentage of the maximum pressure and red indicates the lowest percentage.

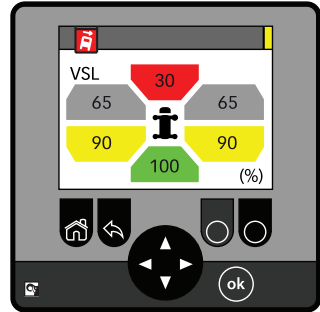

NOTE

The percentages refer to the maximum pressure available in each sector in the 1st boom cylinder, not the percentage of the maximum net load shown the load plate.



NOTE

Always refer to the stability diagram and the lifting capacity diagram delivered by the installer to know which are the lifting capacities and lifting loads that your crane has depending on the stabiliser legs and crane position.

Feature indication

If feature LSS-V is activated the screen turns blue and a symbol of a hook is shown. This to notify the operator of the occurrence. When the screen goes back to normal the symbol of the hook is shown in the top right of the screen. When deactivating LSS-V the screen turns blue again and the hook symbol is shown, this time crossed in a red circle. The hook symbol in the top right of the screen disappears.



8.8.5. Error codes

SPACE has many error codes that can help you or Hiab technicians solve some problems with the system and/or a defective component. You can see the codes if you have the external display or a display on your controller.

If you have an error that is not in the following list, you must speak to an authorised service workshop.



TIP

If you have an error, try to restart the system one time, then verify that you still have the code on the screen before troubleshooting.

E003: Emergency stop

1. Set crane in manual mode.
2. Make sure that no emergency stop buttons are pushed on the crane or the controller.

E010: Lever not centred

Levers are not centred when the emergency stops are released. The error can be caused by lever not in neutral position or defective lever on the controller. If the operator operates a lever before the radio connection is established, the system will stop and the reset by pressing emergency stop is required.

1. Make sure that all the levers are in neutral positions and that spools can move freely in their valves.
2. Make sure that levers and the spools cannot be blocked.
3. Make sure that levers on the controller operate correctly.

E013: Service!

This error shows when one of the service counters (calendar days, hours, use time or number of lifts) has reached the limit (the error led lamp on the User Interface is on with a steady green colour).

- Go to an authorised service workshop.

E016: Remote battery empty

1. Recharge or change the battery in the controller.

E017: Controller

1. Push the emergency stop button and then release it. If you can still see the error, go to an authorised service workshop.

E056: JIB plug conflict

1. There is probably a short circuit inside the JIB plug. Clean the JIB cable connector and the JIB plug.
2. Put electric grease on both the connector and the JIB plug.
3. Set the system to OFF and then back to ON. If you can still see the error, go to an authorised service workshop.

E186: SAF

This error appears only when you move a lever for SAF.

SAF - Slew is in cabin sector

The SAF function cannot start because the crane is positioned in a specified sector where SAF is not available (for example: OLP sector, cabin sector, OPS sector, etc.). Change the crane position and activate SAF again.

SAF – Crane not in position

If the boom system is almost folded but the slew is not in the permitted area, the unfolding function cannot start. The solution is to fold the crane manually, and then the unfolding can be done with the SAF function.

E194: SAF

Refer to E186.

8.8.6. Gateway connection box [option]
POWER LED (1)

The LED is steady green = the gateway has power.

The LED is off = the gateway has no power.

The LED is steady red = the gateway is in standby mode.

The LED shows a red blinking light = the gateway is shutting down.

STATUS LED (2)

The LED is steady green = the gateway is operational and all connections are correct.

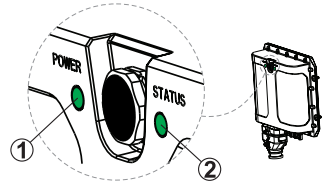

The LED shows a green blinking light = there is an error in the connection.

The LED is off = the gateway is off.

ERRORS

The STATUS LED (2) shows the status of the connection between the gateway, SPACE, GPS, and 3G/4G.

You can read different error codes from the STATUS LED on the gateway. If two or more errors exist in the system, the blinking sequence will show them in the same sequence.

Error code number	Blinking sequence	Problem	Possible cause
1	1 blink 	The gateway is not able to read the product data (this state is not in use in the factory image).	<ul style="list-style-type: none"> • SPACE is not on. • The cable between SPACE and the gateway is not connected correctly. • The gateway is not configured correctly. Contact Effer support.
2	2 blinks 	The gateway is not able to connect to the Cargotec cloud.	<ul style="list-style-type: none"> • Poor 3G/4G coverage. • The antenna is not connected correctly or it is damaged. • The gateway is not configured correctly. Contact Effer support.
3	3 blinks 	The gateway is not able to read the correct GPS location.	<ul style="list-style-type: none"> • The antenna is not connected correctly. • Poor GPS signal strength.

Error code number	Blinking sequence	Problem	Possible cause
5	5 blinks 	The gateway is not operational yet.	<ul style="list-style-type: none"> • Software is updating.

**NOTE**

If the system stops while the software is updating, the update will be put on hold until the system starts again.

Example: Several errors exist in the system.

Error 2 and 3 exist in the system.

**NOTE**

If error 1, 2, and 3 exist in the same time, do a check that you have the correct Gateway kit (**EU** for European Union GB or **US** for United States, Canada and Mexico).

9. Decommissioning

9.1. Decommissioning a crane



NOTE

Only qualified companies can remove the crane from the truck and dispose of it.

Cranes are designed and manufactured taking the environment into consideration. Environmental requirements and soundness have been considered when selecting the raw materials. The metal parts are designed to achieve a light and durable construction; this includes the selection of higher-quality grades of steel. When the crane is decommissioned at the end of its service life, years from now, waste will be created, which must be utilised and disposed of correctly. The crane must be decommissioned properly. Most of the crane's raw materials can be recycled.

Follow the regulations of the local authorities!

- Oil and grease must not be spilled on to the ground or released into the environment!
- Drain the oil from hydraulic cylinders, valves and hoses.

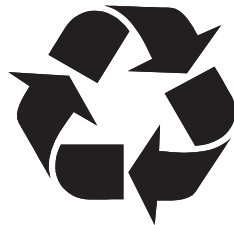

Sort the waste

- Deliver the metal parts for recycling, for reuse as raw material. These are load-bearing, structures manufactured from steel or cast iron, hydraulic cylinders and lines drained of oil, directional control valves, shafts, bearing bushes, control levers, small parts.

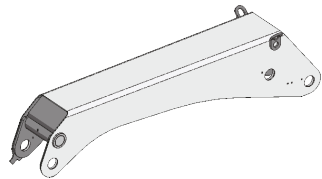

Energy waste can be utilised by incinerating it at a proper waste incineration plant.

- Spiral wraps, manufactured from polyethylene, plastic, bearings (cleaned of lubricants) used in the column, beam system etc, manufactured from polyamide plastic.

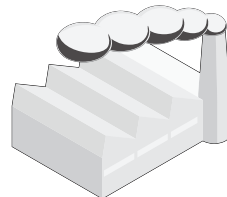

Unsorted waste should be delivered to a landfill.

- Drained hydraulic hoses, electrical wires, control cables, seat, hydraulic cylinder seals, lights, small plastic and rubber parts.



Hazardous waste is delivered to a collection point for hazardous waste.

- Oils: hydraulic oil, transmission oil from the slewing system
- Solid lubricants: greases from the joints and journal bearings
- Other waste containing oils and greases: hydraulic oil filters.



European Union—Disposal Information

This symbol identifies the parts of your crane that need to be disposed of separately from household waste according to EU legislation. When one of these parts reaches the end of its life, take it to a collection site designated by local authorities. Responsible collection and recycling help protect natural resources, the environment, and human health.

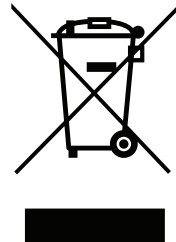

10. Technical Data

10.1. Load plate table

When the crane has VSL [option], the Installer should fill in the valid meters (**m**) or feet (**ft**) and kilos (**kg**) or pounds (**lb**) in this table, following instructions given in the Installation instructions.

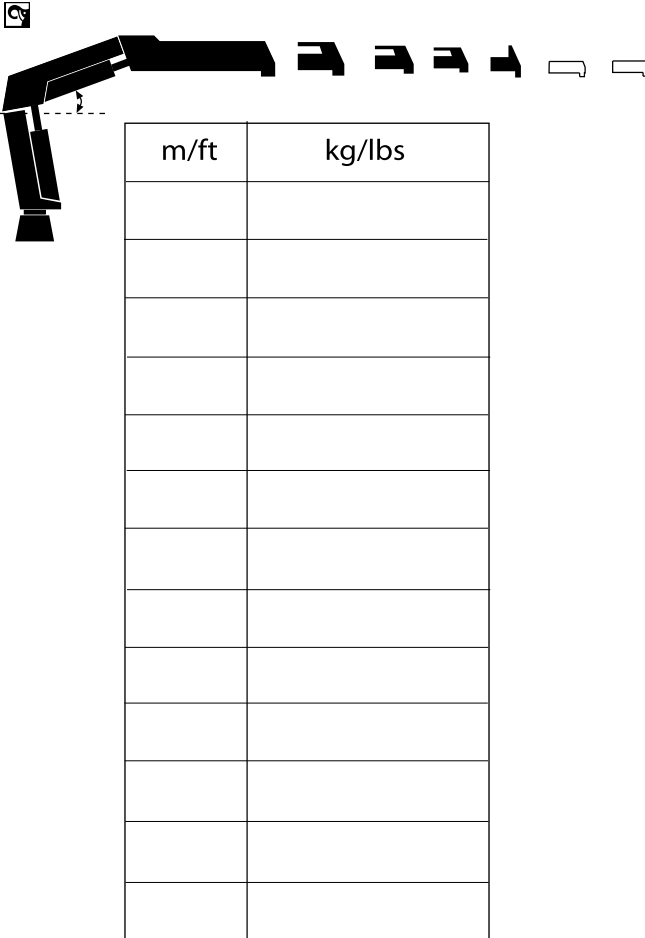

m/ft	kg/lbs

10.2. Documentation

The Technical Data document shows diagrams and technical information about your specific crane

The enclosed Technical Data printed out by the installer should be stored together with this Operator's manual.

10.3. Identification of the loader crane

The information below is to be filled in by the installer. The same information will be found on the serial number plate on the crane:

Mark: EFFER

Type:

Serial number:

Manufact. year:

Model year:

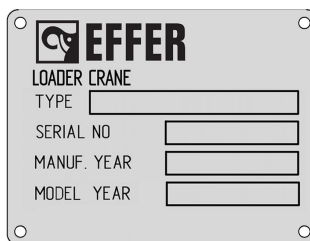

10.4. Theoretical using time Hoist

Drive group	M3
class of operating time	T3
theoretical using time (years)	12.8 - 6.4
at an average, daily operat. time (h)	0.5 - 1.0
calc. total operating time (h)	1600
load spectrum	L2
hours of full line pull (h)	400



CAUTION

Hoist systems have to undergo a general repair/service after the end of the theoretical using time.



CAUTION

In the country of application, the national regulations which are individually valid for hoisting and pulling units, have to be followed.

10.5. Performance Data TC1, rope capacity

Rope diameter 8 mm

Rope capacity according to DIN 15020 Grooved drum	Rope layer			
	1	2	3	4
Max. hoisting force [kN]	11.5	11	10	9.5
Rope length in m/layer, rope diameter 8 mm	10	12	12	13 (4*)
Total rope length [m]	10	22	34	47 (38*)
Weight in kg (ca): ¹⁾ hoist ²⁾ hoist + rope	¹⁾ 54 ²⁾ 64			
Max. oil flow [l/min]	40			
Noise level [dBA]	83			

(*) rope length 38 m

10.6. Performance Data TI1, rope capacity

Rope diameter 8 mm



Data based on basic hoist without options	Rope layer				
	1	2	3	4	5
Max. hoisting force [kN]	12.5	11.5	10.5	10	9.5
Total rope length [m]	10	21	34	46 (38*)	60
Weight in [kg] (approx.): ¹⁾ hoist ²⁾ hoist + rope	¹⁾ 53 ²⁾ 63				
Max. oil flow [l/min]	44				
Noise level [dBA]	88				

(*) rope length 38 m



10.7. Abbreviations

- ADC - ('Automatic Duty Control') - Automatic Duty Control
- ADO - ('Automatic Dumping of Oil') - Automatic Dumping of Oil
- APO - ('Automatic Power Off') - Automatic Power Off
- ASC - ('Automatic Speed Control') - Automatic Speed Control
- BDA - ('Boom Deployment Assistant') - Boom Deployment Assistant
- DA modules - ('Digital Amplifier Modules') - Digital Amplifier Modules
- JDC - ('Jib Dual Capacity') - Jib Dual Capacity
- LSS-H - ('Load Stabilising System-Horizontal') - Load Stabilising System-Horizontal
- MEWP - ('Mobile Elevating Work Platform') - Mobile Elevating Work Platform
- MSC - ('Manual Speed Control') - Manual Speed Control
- MUX - ('Multiplexer Box') - Multiplexer Box
- OLP - ('Overload Protection') - Overload Protection
- OPS - ('Operator Protection System') - Operator Protection System
- PFD - ('Pump Flow Distribution') - Pump Flow Distribution
- PSB - ('Power Supply Box') - Power Supply Box
- SAF - ('Semi Automatic Folding') - Semi Automatic Folding
- SCB - ('Stabiliser Control Box') - Stabiliser Control Box
- SSL - ('Sector Stability Limit') - Sector Stability Limit
- UI - ('User Interface') - User Interface
- VSL - ('Variable Stability Logic') - Variable Stability Logic

10.8. Daily inspection checklist

Operator			Document ID:	
Crane s/n:			Date:	
DAILY INSPECTION				Comments
Presence of signs and symbols				
Locking devices				
Spirit level				
Shafts, locking shafts, bearings and bushings				
Crane structure				
Hooks				
Lifting accessories, interchangeable equipment and optional crane components				
Electronic components				
Security seal wires				
Hydraulic system and oil level in the tank				
Oil level in the slewing housing and condition				
Oil level in the slewing motors and condition				
Filters				
FUNCTIONAL TESTS				
Emergency stop buttons				
Levers				
Controller				
Horn and LED test				
<p>If you find a fault that prevents you from operating the crane safely, contact an authorised service workshop. Do not try to repair the fault, it can cause you injury or you can damage the equipment.</p> <p>Permission to reproduce this checklist is granted; however please note that only the original document owned by Hiab will contain necessary amendments and updates. Hiab shall not be held liable if the copy in your possession does not contain the latest changes.</p>				

10.9. Monthly inspection checklist

Operator			Document ID:	
Crane s/n:			Date:	
MONTHLY INSPECTION				Comments
Piston rods				
Pivot pins and bushes				
Bolts and screw fixings				
Cables and sensors				
Lubrication schedule				
Slewing bearing / Upper column bearing				
Pump attachment screws				
Gateway connectivity				
<p>If you find a fault that prevents you from operating the crane safely, contact an authorised service workshop. Do not try to repair the fault, it can cause you injury or you can damage the equipment.</p> <p>Permission to reproduce this checklist is granted; however please note that only the original document owned by Hiab will contain necessary amendments and updates. Hiab shall not be held liable if the copy in your possession does not contain the latest changes.</p>				

This page is intentionally left blank.

© EFFER

All rights reserved.

No part of this publication may be reproduced or copied in any form or by any means without written permission from EFFER.

EFFER is part of Cargotec Corporation.



EFFER