

155Q X4



JIB Operator's Manual GB

737 4169



Congratulations!

You are now the owner of a quality Product manufactured by Hiab (part of Cargotec Corporation).

The aim of this manual is to help you handle, maintain your crane safely and with full satisfaction.

This Manual provides detailed information about your Product, its control systems and its practical management and maintenance.

Please read the complete Manual carefully and make sure that you understand its contents. Please also carefully familiarise yourself with your Product before you start to use it.



Help us to improve this manual. Please send your comments and suggestions to **documentation@hiab.com**

This manual applies to JIBs that operate with the crane control system SPACE
X4 from serial number 222178

2023-03

This page is intentionally left blank.

Table of Contents

1. Introduction	7
1.1. This Operator's Manual is intended for operators of cranes with a JIB	7
1.2. The JIB	8
1.3. The Machinery Directive 2006/42/EC	9
1.4. The Machinery (Safety) Regulations 2008	10
1.5. Identification of JIB	10
2. Structure and parts of the JIB	11
2.1. JIB Components	11
3. Safety precautions and warnings	12
3.1. Safety precautions and warnings	12
4. Hydraulic connections	14
4.1. Hydraulic quick couplings [option]	14
4.2. Hydraulic quick couplings (MULTI-X) [option]	16
5. Operation	17
5.1. Assembling the JIB.155Q (without hoist)	17
5.2. Disassembling the JIB.155Q (without hoist)	19
5.3. SAF Semi Automatic Folding [option]	21
5.4. Operate the crane with JIB (without hoist) out of parked position	23
5.5. Working with the JIB	25
5.5.1. Operation with the 5th and 6th functions	25
5.5.2. How to achieve sufficient reach	26
5.5.3. (JDC) JIB Dual Capacity [option]	27
5.6. SAF Semi Automatic Folding [option]	27
5.7. Operate the crane with a JIB (without hoist) to parking position	30
5.8. OLP and JIB	32
5.9. Manual extensions [option]	32
5.9.1. Assembling and disassembling JIB manual extensions	33
5.10. Raised hook support [option]	36
5.11. Special hook application without disassembling the JIB	37
6. Operation with hoist	38
6.1. Operation with hoist	38
6.2. Displacing the hoist	38
6.2.1. Displacing the hoist with the XSDrive	38
6.2.2. Displacing the hoist with the CombiDrive	39
6.3. Connecting the hoist TI2L/TI4 rope to the JIB.155Q	39
6.4. Disconnecting the hoist TI2L/TI4 rope from the JIB.155Q	41
6.5. Assembling the JIB.155Q with hoist TI2L/TI4	42
6.6. Disassembling the JIB.155Q with hoist TI2L/TI4	42
6.7. Operating a crane with JIB.155Q and hoist TI2L/TI4 out of parked position	43
6.8. Operating a crane with JIB.155Q and hoist TI2L/TI4 to parking position	43
6.9. Operating with hoist TI2L/TI4 (without JIB.155Q)	44
7. Maintenance	46
7.1. Maintenance and service	46
7.2. Lubrication	46
7.3. Lubrication schedule	48
7.4. Faults	49
8. Technical Data	50

This page is intentionally left blank.

1. Introduction

1.1. This Operator's Manual is intended for operators of cranes with a JIB

This manual describes

- operation
- maintenance and faults

This manual is a supplement to the Operator's Manual for your type of crane.



DANGER

If you have not studied the complete Operator's Manual for your crane and for your JIB carefully, it could lead to fatal accidents or serious damage.

Therefore you should:

- Study the entire Operator's Manual carefully.
- Operate the crane only after you have done so.
Follow the directions for use, operation and maintenance of the crane exactly.



NOTE

The manufacturer reserves the right to change specifications, equipment, operating instructions and maintenance instructions without prior notice.

1.2. The JIB

The JIB is an interchangeable equipment that extends the crane boom. Use the JIB so as to be able to reach further.

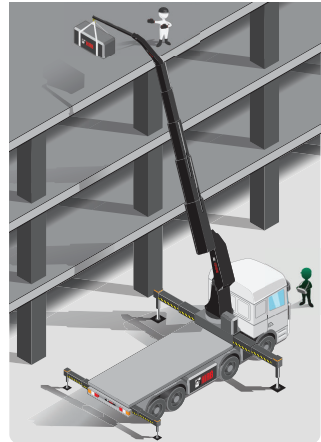

NOTE

- Load diagram signs for the JIB are placed on the column.
- See the Technical Data for the precise technical information concerning the JIB on your crane.

Crane configurations where JIB.155Q can be installed:

Model	JIB.155Q	JIB.155Q - JDC
EFFER iQ.950-1200 HP	E-8-9	E-9

Using the JIB upside down is permitted (e.g. work under bridges with a personal basket).



1.3. The Machinery Directive 2006/42/EC

- The Declaration of Conformity, delivered with the equipment contains (1):
- Business name and full address where the interchangeable equipment is manufactured (2):
 Factory addresses:
 Hiab Cranes S.L.U. Pol. Ind. Malpica, calle E, 86 50016 Zaragoza, Spain
 Cargotec Poland Sp. z o. o. Ul. Metalowa 2, 73-102 Stargard, Poland
 Hiab Italia S.r.l. Via IV Novembre 12, 40061 Minerbio (BO), Italy
- Description and identification of the equipment (3):
 Mark
 Type: see chapter Identification of the interchangeable equipment.
 Serial number
 Manufact. year
 Declaration of which provisions the equipment fulfils.
- Name and address of the person authorised to compile the technical file (4):
 Name
 Address
- Identity and signature of the person who drawn up the declaration (5):
 Name
 Position
 Date and Signature

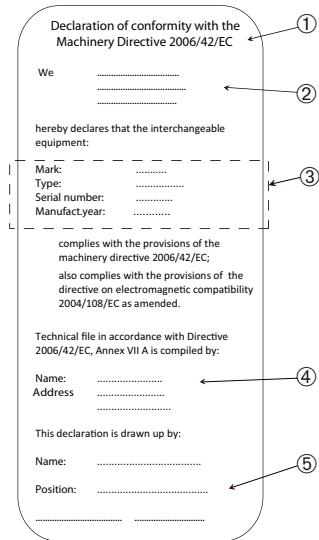

Declaration of conformity with the Machinery Directive 2006/42/EC

We _____

_____ hereby declares that the interchangeable equipment:

Mark: _____

Type: _____

Serial number: _____

Manufact. year: _____

_____ complies with the provisions of the machinery directive 2006/42/EC; also complies with the provisions of the directive on electromagnetic compatibility 2004/108/EC as amended.

Technical file in accordance with Directive 2006/42/EC, Annex VII A is compiled by:

Name: _____

Address: _____

This declaration is drawn up by:

Name: _____

Position: _____

1.4. The Machinery (Safety) Regulations 2008

- The Declaration of Conformity, delivered with the equipment contains (1):
- Business name and full address where the interchangeable equipment is manufactured (2):
 Factory addresses:
 Hiab Cranes S.L.U. Pol. Ind. Malpica, calle E, 86 50016 Zaragoza, Spain
 Cargotec Poland Sp. z o. o. Ul. Metalowa 2, 73-102 Stargard, Poland
 Hiab Italia S.r.l. Via IV Novembre 12, 40061 Minerbio (BO), Italy
- Description and identification of the equipment (3):
 Mark
 Type: see chapter Identification of the interchangeable equipment.
 Serial number
 Manufact. year
 Declaration of which provisions the equipment fulfils.
- Name and address of the person authorised to compile the technical file (4):
 Name
 Address
- Identity and signature of the person who drawn up the declaration (5):
 Name
 Position
 Date and Signature

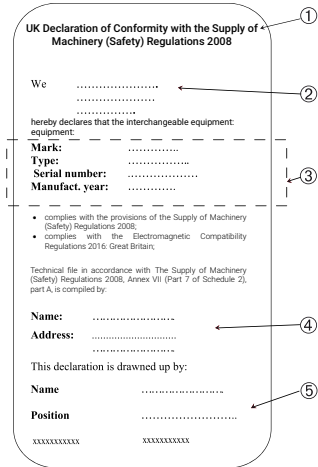

UK Declaration of Conformity with the Supply of Machinery (Safety) Regulations 2008

We

 hereby declares that the interchangeable equipment:
 equipment

Mark:
 Type:
 Serial number:
 Manufact. year:

• complies with the provisions of the Supply of Machinery (Safety) Regulations 2008;
 • complies with the Electromagnetic Compatibility Regulations 2016 Great Britain.

Technical file in accordance with The Supply of Machinery (Safety) Regulations 2008, Annex VII (Part 7 of Schedule 2), part A, is compiled by:

Name:
 Address:

This declaration is drawn up by:

Name
 Position

XXXXXXXXXX XXXXXXXXXXXX

1.5. Identification of JIB

Description and identification of the JIB:

Mark:

Type: **JIB.155Q**

Serial number:

Manufact. year:

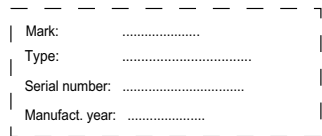

Mark:
 Type:
 Serial number:
 Manufact. year:

2. Structure and parts of the JIB

2.1. JIB Components

The JIB consists of the following components:

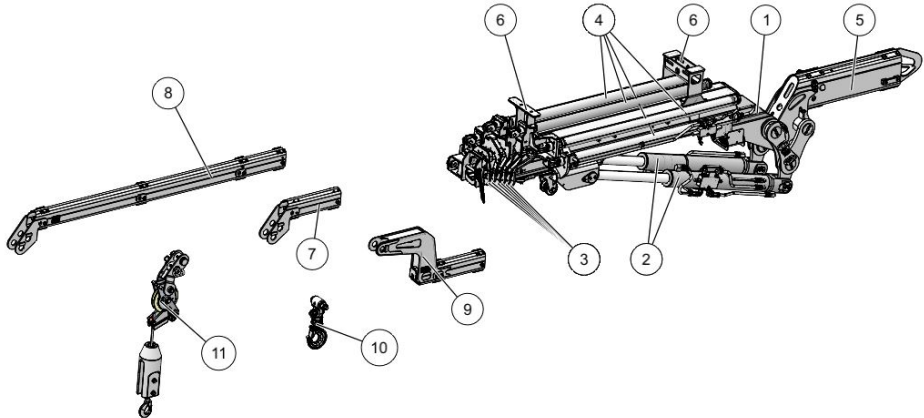

Main components:

- (1) JIB boom
- (2) JIB cylinder
- (3) JIB extension
- (4) JIB extension cylinder
- (5) JIB support
- (6) JIB support for the ground

Some accessories can be installed depending on your crane and JIB configuration:

- (7) JIB hook support [option]
- (8) JIB manual extension [option]
- (9) Raised hook support [option]
- (10) Hook [option]
- (11) Hoist top-roller [option]

3. Safety precautions and warnings

3.1. Safety precautions and warnings



DANGER

If you have not studied the Operator's Manual for your crane carefully, it could lead to fatal accidents or serious damage.



DANGER

When using the JIB, always connect the JIB to the SPACE Safety System.

Without this connection, the OLP protection for the JIB is not activated.

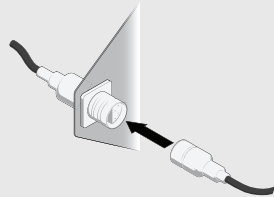

DANGER

Load diagram JIB

Load diagram signs on the column show the maximum loads in the working zone for your JIB.

Never exceed the JIB's maximum permitted load!

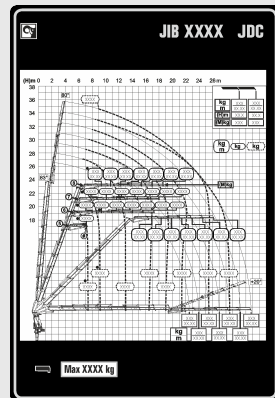

NOTE

When you use equipment such as hoist, JIB, lifting accessories or interchangeable equipment and their necessary components, you add weight to the load. Because of this, the load you can lift is less heavy.



DANGER

Always check that the JIB is firmly attached before use.



WARNING

The operation of a crane with JIB is different from the operation of a crane without it. For example, there is a big difference when you need to put the crane in and out of transport position.

To prevent damage to the JIB: study this instruction carefully before operating the crane with the JIB.

4. Hydraulic connections

You can disconnect a hydraulic line or a hose only for specific operator's tasks (for example, disconnecting the interchangeable equipment).



DANGER

- STAY AWAY from oil leaks in the hydraulic system! Oil in the hydraulic system is under high pressure, can spill, be very hot and cause you injury.
- Do not replace any hydraulic hoses or lines yourself.



WARNING

- Switch off the control system and the PTO before connecting or disconnecting the electrical and hydraulic connections.
- Keep the electrical and hydraulic protection caps and plugs in good condition and store them in a safe place.

4.1. Hydraulic quick couplings [option]

Hydraulic quick couplings allow a faster connection and disconnection of each hydraulic line.



WARNING

- Switch off the control system and the PTO before connecting or disconnecting the connectors.
- Always remove/attach first the electrical connection before the hydraulic connection.
- Keep the electrical and hydraulic protection caps and bypass in good conditions and store them in a safe place.

To connect the hydraulic quick couplings you must:

1. Switch off the control system.
2. Disengage the PTO.
3. Remove the protection caps.
4. Connect the respective hydraulic quick couplings taking care with the corresponding identification:
 - Yellow and blue collars = 5th function
 - Red and green collars = 6th function

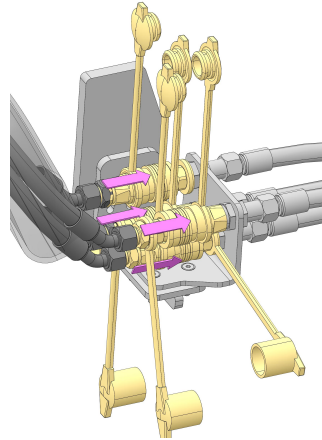

NOTE

To prevent damage, do not change the hydraulic quick couplings position.

5. Reconnect the PTO and switch on the system, if needed.
6. Do a functional test of all movements of the interchangeable equipment to verify that there are no mistakes in the connections.

To disconnect the hydraulic quick couplings you must:

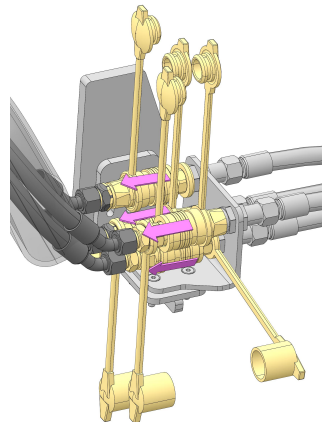
1. Switch off the control system.
2. Disengage the PTO.
3. Disconnect the hydraulic couplings, and protect them with protective caps.
4. Reconnect the PTO and switch on the system, if needed.
5. Operate the crane to verify that all functions work correctly.



4.2. Hydraulic quick couplings (MULTI-X) [option]

Hydraulic quick couplings allow the connection of several hydraulic lines at the same time.



WARNING

- Switch off the control system and the PTO before connecting or disconnecting the connectors.
- Always remove/attach first the electrical connection before the hydraulic connection.
- Keep the electrical and hydraulic protection caps and bypass in good conditions and store them in a safe place.

To connect the hydraulic quick couplings you must:

1. Switch off the control system.
2. Disengage the PTO.
3. Remove the protection caps.
4. Turn the lever to the upper position to allow the hydraulic connection.
5. Connect the hydraulic quick coupling MULTI-X (1).
6. Turn the lever to the lower position (2). Make sure that the lever locks the connection correctly.
7. Reconnect the PTO and switch on the system, if needed.
8. Do a functional test of all movements of the interchangeable equipment to verify that there are no mistakes in the connections.

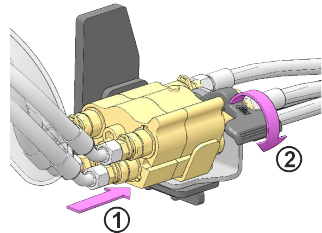

To disconnect the hydraulic quick couplings you must:

1. Switch off the control system.
2. Disengage the PTO.
3. Turn the lever to the upper position (1).
4. Disconnect the hydraulic couplings (2), and protect them with protective caps.
5. Turn the lever to its initial position.
6. Reconnect the PTO and switch on the system, if needed.
7. Operate the crane to verify that all functions work correctly.

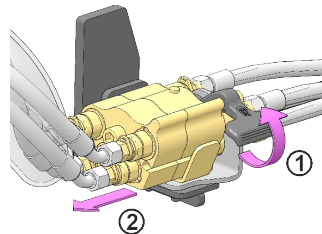

5. Operation

5.1. Assembling the JIB.155Q (without hoist)

**WARNING**

Take care, when assembling and disassembling the JIB that your fingers do not get trapped.

**WARNING**

- Switch off the control system and the PTO before connecting or disconnecting the electrical and hydraulic connections.
- Keep the electrical and hydraulic protection caps and plugs in good condition and store them in a safe place.

1. Remove the hook, hook support or accessory from the tip of crane.
2. Remove the locking devices from the tip of the crane:
 - a. Remove the locking pin (1).
 - b. Push the shaft (2) and slew 90° until it is unlocked.
 - c. Remove the shaft (2).

3. Assemble the JIB on the crane:
 - a. Operate the crane to align the boom system with the JIB support.
 - b. Carefully extend the crane extension to put the JIB support in the last crane extension.
 - c. Push the shaft (2) and slew 90° until is locked.
 - d. Slew 90° the shaft (2) checking that the shaft is blocked.
 - e. Install the locking pin (1).

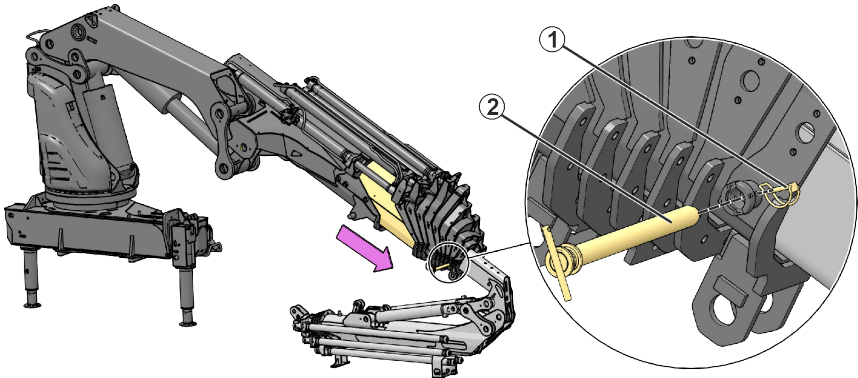

DANGER

Check that the JIB is firmly attached!

Check that the locking pin and the securing plate are firmly attached

4. Carefully connect the JIB to the hydraulic system:



WARNING

Clean the quick connect coupling on the hydraulic system and on the JIB. Dirt will cause serious damage to the hydraulic system.

- a. Switch off the control system and the PTO before connecting the hydraulic system.
- b. Release the pressure on the hydraulic system. Operate the levers on the main control valve for the JIB functions.
- c. Connect the hydraulic couplings.



NOTE

Refer to the content [Section 4: Hydraulic connections \(page 14\)](#) for further information.

5. Connect the JIB to the control system:
 1. Connect the JIB to the hydraulic system.
 2. Connect the JIB to the SPACE safety system:
 - remove the plug (1)
 - connect the JIB contact (2)

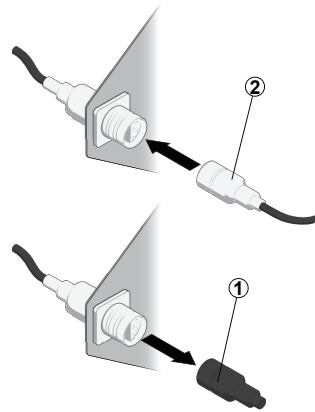

DANGER

- When using the JIB, always connect the JIB to the control system.
- Never use the JIB without connecting it to the control system. Otherwise the OLP for the JIB is not activated.

6. Carefully operate the crane and JIB. Make sure that the JIB is firmly attached and it works correctly.

5.2. Disassembling the JIB.155Q (without hoist)



WARNING

- Take care, when assembling and disassembling the JIB that your fingers do not get trapped.
- Disassemble the JIB carefully. Rough and careless handling can damage the JIB.

1. Operate the crane and put it in a safe area to disassemble the JIB.
2. Remove the hook from the JIB, if needed.
3. Fully retract the crane and JIB extensions.
4. Operate the crane and JIB:
 - a. Extend the 2nd boom cylinder totally to reach a similar position as shown on the picture.
 - b. Extend the crane extensions at least the length of the JIB support (800 mm approx.).
 - c. Lower the JIB very carefully on to a level surface until the JIB supports for the ground rest on the ground.

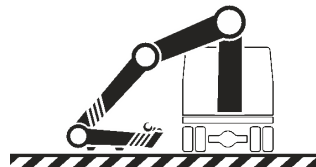

CAUTION

Make sure that the tip of the crane and the JIB are not damaged in this operation.

5. Disconnect the JIB from the control system:
 - a. Disconnect the cable contact (4).
 - b. Put the plug (5) back in place.

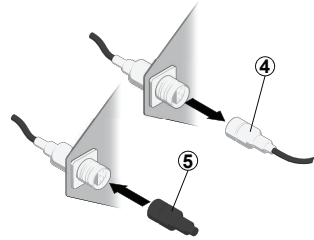
NOTE

Make sure that the plug is connected. Without this plug the control system senses the JIB still attached to the crane.

- c. Protect the JIB connector with a cap.
6. Carefully disconnect the JIB from the hydraulic system:
 - a. Switch off the control system and the PTO before disconnecting the hydraulic system.
 - b. Release the pressure on the hydraulic system. Operate the levers on the main control valve for the JIB functions.
 - c. Disconnect the hydraulic couplings, and protect them with protective caps.



NOTE

Refer to the content [Section 4: Hydraulic connections \(page 14\)](#) for further information.

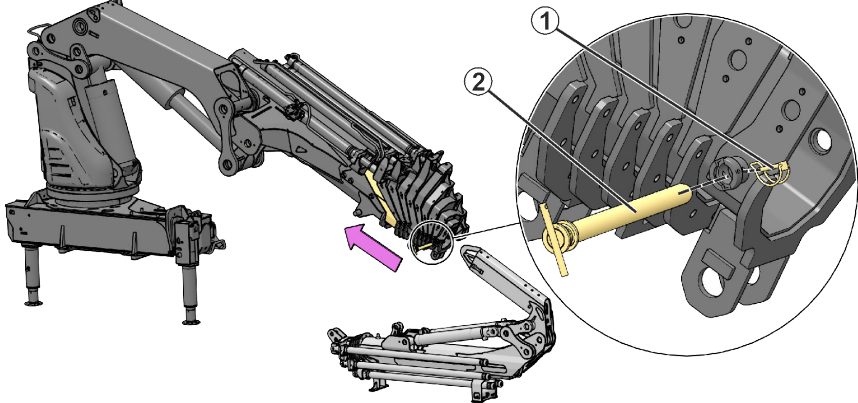
7. Remove the JIB from the tip of crane:
 - a. Remove the locking pin (1).
 - b. Push the shaft (2) and slew 90° until it is unlocked.
 - c. Remove the shaft (2).

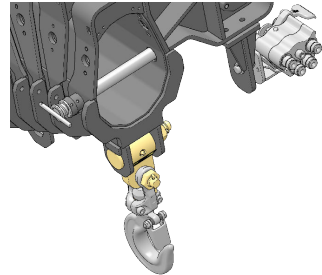

8. The JIB is now free from the crane. Carefully retract the crane extension away from the JIB support.
9. If you are going to work with the hook on the tip of the crane:
 - a. Attach the hook support to the last crane extension.
 - b. Attach the hook to the hook support.



5.3. SAF Semi Automatic Folding [option]

SAF is a feature which allows the operator to fold or unfold the boom system in one single sequence using only one lever.



Unfold the boom system semi automatically



WARNING

Never use SAF with mounted tools.



WARNING

Make sure there is enough space for the boom system to unfold/fold semi automatically. If the situation does not allow SAF, use crane mode to operate the boom system out of/into the parked position.

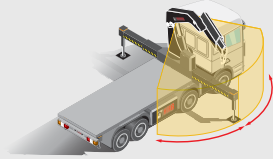

WARNING

If your crane has manual extensions, make sure that they are totally retracted or removed before operating the crane with the SAF feature.



WARNING

If your crane has long JIB support, make sure that it is totally retracted before operating the crane with the SAF feature.





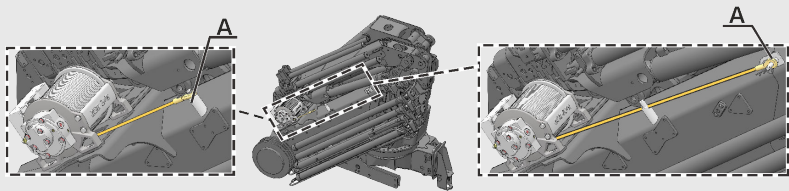

WARNING

If your crane has a hoist, change from hoist to hook operation.

Make sure that the rope is on the 2nd boom support and it does not pass through any pulley. If not, remove the rope from the pulleys and put it in the 2nd boom support (A) before operating the crane with the SAF feature.



1. Select the menu for SAF on the controller.
2. If SAF is not configured in a separate crane menu, push the button  to activate it.
3. Operate the lever on the controller until the boom system has been fully unfolded:
 - XSDrive  or 
 - CombiDrive  or 

**DANGER**

Pay careful attention when using this feature.

Always maintain eye contact when operating the crane.

During this movement, the boom system will unfold itself, release the lever immediately if the boom system is about to:

- Hit a person
- Hit an object
- Hit a moving obstacle that suddenly comes closer to the crane.

4. If SAF is not configured in a separate crane menu, push button  to deactivate it.

5.4. Operate the crane with JIB (without hoist) out of parked position

**DANGER**

Position the stabiliser extensions and legs on the ground.

**WARNING**

Always operate a crane with a JIB very carefully. The space for moving the boom system and the JIB is limited. Make sure that there is enough space available. Careless or rough crane movements can seriously damage the crane and the JIB.

EFFER iQ.950-1200 HP

NOTE

SAF option is possible with this crane configuration.

When the stabiliser extensions are extended, the catcher “A” will be released and allow the movements of the 1st boom.

1. Increase the pressure in the cylinders on the crane and JIB before starting the operation.

CAUTION

Do these operations slowly to not damage any parking support or parking pins of the crane and JIB.

- a. Retract the JIB extensions (1) carefully.
- b. Operate the JIB against the 2nd boom (2) carefully.
- c. Retract the crane extensions (3) carefully.
- d. Operate the 2nd boom against the 1st boom (4) carefully.

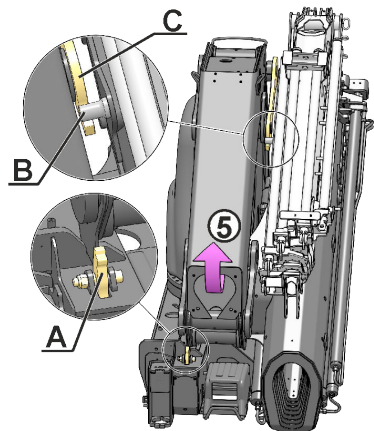
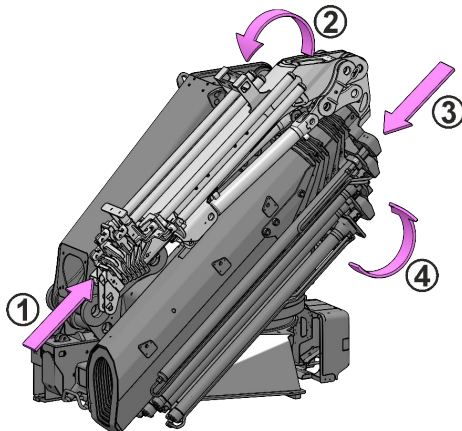

2. Raise the 1st boom (5) until BDA allows you to operate the 2nd boom or $\beta > 135^\circ$.

CAUTION

Do these operations slowly to not damage the parking pin “B” or the parking support “C”.

- Raise the 2nd boom (6).



CAUTION

Pay careful attention not to damage the slewing motors.

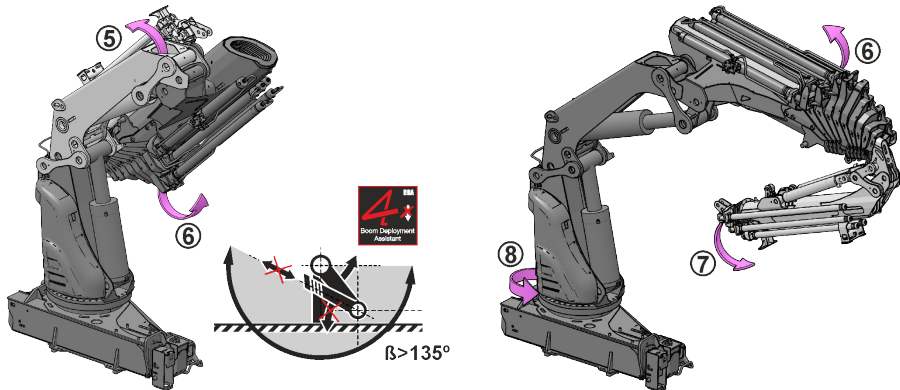

- Raise the JIB (7). Make sure that the 1st boom and 2nd boom are unfolded before starting this JIB operation.
- Slew the crane (8) to working position.

5.5. Working with the JIB

5.5.1. Operation with the 5th and 6th functions

The JIB is operated with the 5th and 6th functions of the control valve or from the remote control.

Crane Speed

With the boom system fully extended: work at low crane speed.



WARNING

If the JIB extensions are extended, do not push the JIB tip against the ground. You will damage it.

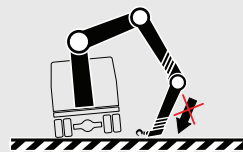

5.5.2. How to achieve sufficient reach

1. First extend the crane extensions completely.
2. Then extend the JIB as far as needed.

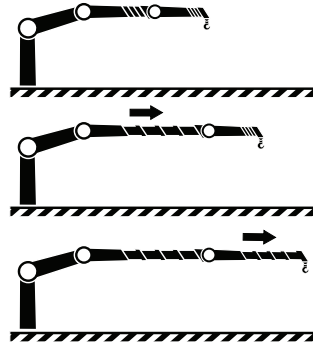

WARNING

Do not slew the crane until the load is completely free of the ground.



DANGER

Never exceed the JIB's maximum permitted load.



WARNING

In high boom positions, retract the JIB extensions before retracting crane extensions. Otherwise, unexpected side movements of the boom system can occur, causing dangerous movements of the load.

5.5.3. (JDC) JIB Dual Capacity [option]

JDC is a feature that increases the lifting capacity on the JIB, allowing extra capacity on the JIB when the last crane extension is fully retracted. (This position is automatically detected by the control system.)

- When the last crane extension is extended, the lifting capacity of the JIB will be standard to prevent overload.
- When the last crane extension is fully retracted, the JDC allows to use the JIB with extra capacity. JDC will prevent the last crane extension to extend when the JIB is working with the extra capacity.

See the load diagram signs on the column.

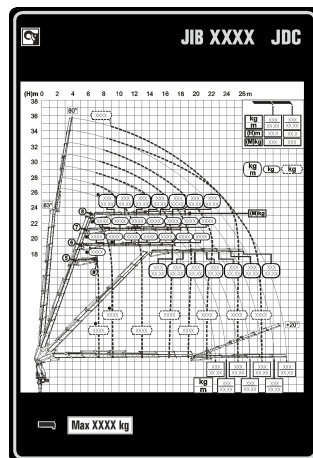

5.6. SAF Semi Automatic Folding [option]

SAF is a feature which allows the operator to fold or unfold the boom system in one single sequence using only one lever.



Fold the boom system semi automatically



WARNING

Never use SAF with mounted tools.



WARNING

Make sure there is enough space for the boom system to unfold/fold semi automatically. If the situation does not allow SAF, use crane mode to operate the boom system out of/into the parked position.

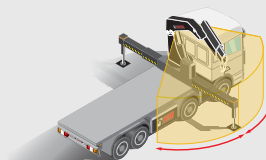

WARNING

If your crane has manual extensions, make sure that they are totally retracted or removed before operating the crane with the SAF feature.







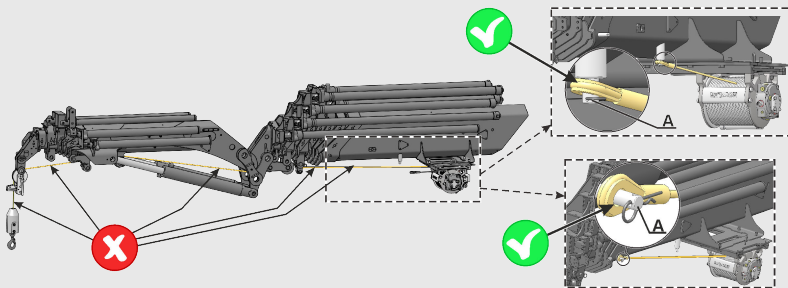

WARNING

If your crane has long JIB support, make sure that it is totally retracted before operating the crane with the SAF feature.



WARNING





If your crane is equipped with a hoist, change from hoist to hook operation. Displace the hoist, if needed, to the outside position before operating the crane to parking position with JIB and hoist. Make sure that the rope is on the 2nd boom support and does not pass through any pulley. If not, remove the rope from the pulleys and fit it in the 2nd boom support (A) before operating the crane with the SAF feature.



1. Select menu for SAF on the controller.
2. If SAF is not configured in a separate menu, push button  to activate it.
3. Operate lever on the controller until the extensions are fully retracted:
 - XSDrive  or 
 - CombiDrive  or 
4. Confirm on the controller that the extensions are totally retracted:
 - XSDrive 
 - CombiDrive 

NOTE

If you stop the SAF sequence, remember that when you start it again, the crane will not move. You must push the confirm button/lever  or  on the controller to continue with the sequence. Push this button/lever once, because it activates/deactivates the SAF sequence. So, if you push the button twice you will need to push it again to continue with the SAF sequence.

5. Continue operating lever on the controller until the boom system is totally folded:
 - XSDrive  or 
 - CombiDrive  or 

**DANGER**

Pay careful attention when using this feature.

Always maintain eye contact when operating the crane.

During this movement, the boom system will fold itself, release the lever immediately if the boom system is about to:

- Hit a person
- Hit an object
- Hit a moving obstacle that suddenly comes closer to the crane.

6. If SAF is not configured in a separate menu, push button  to deactivate SAF.

5.7. Operate the crane with a JIB (without hoist) to parking position



WARNING

Always operate a crane with a JIB very carefully. The space for moving the boom system and the JIB is limited. Make sure that there is enough space. Careless or rough crane movements can seriously damage the crane and the JIB.

Retract the JIB extensions first.

Then retract the crane extensions.

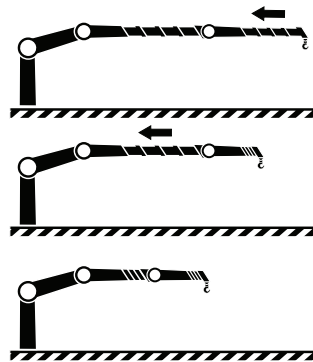

EFFER iQ.950-1200 HP



NOTE

SAF option is possible with this crane configuration.

1. Make sure that the JIB and crane extensions are retracted completely (1).
2. Raise the 1st boom (2) until BDA allows you to operate the 2nd boom or $\beta > 135^\circ$.
3. Slew the crane (3) to parking position. Check that arrows "A" are aligned.
4. Operate the JIB towards the 2nd boom (4) till the parking support "B" rests on the 2nd boom.

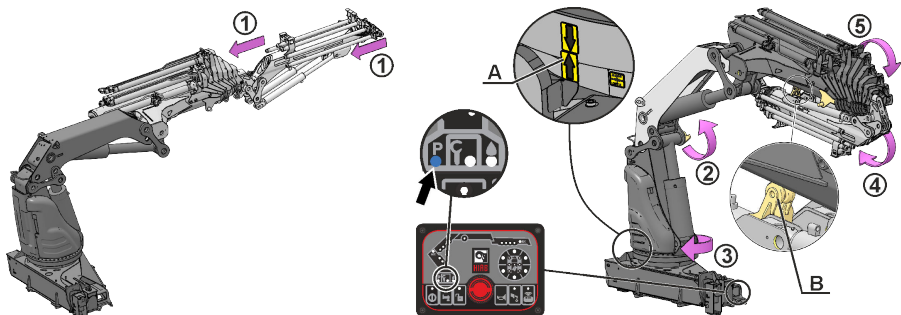

5. Operate the 2nd boom against the 1st boom (5).



CAUTION

Pay careful attention not to damage the slewing motors.

- Lower the 1st boom completely (6). Check if the parking support “C” rests on the slot “D”. When the stabiliser extensions are retracted, the catcher “E” will lock the 1st boom and hold the boom system in parking position.



CAUTION

Do these operations slowly to not damage the parking supports.

- Release OLP.

Press the button “F” on the controller for remote control operation or the button on the User Interface for manual operation.
- Operate the 2nd boom (7) against the support “G” until it has contact with the support.

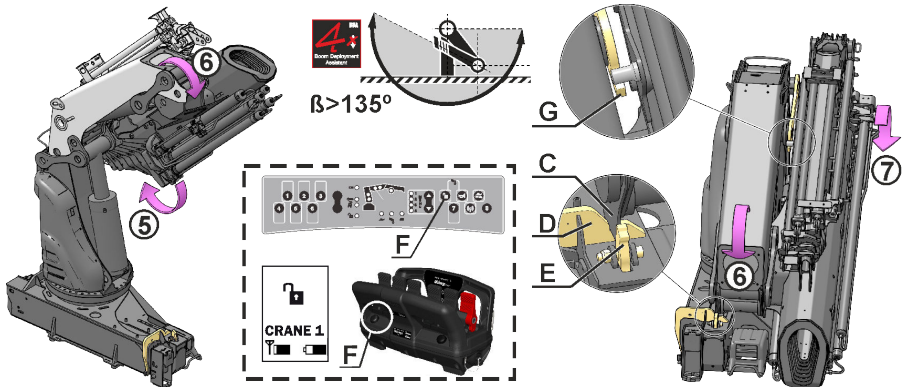

CAUTION

Take care not to damage the 2nd boom and the support during these operations.

- Fold the hook.

5.8. OLP and JIB

OLP prevents the JIB from being overloaded:

When the load is close to the rated capacity the OLP gives a pre-warning.

- The cylinder pressure LED's flash red.

At the rated capacity, a new warning is given.

- The indicator LED's light up red.

Prohibited movements are stopped. Move the levers to neutral, and then only operate permitted (load reducing) functions.

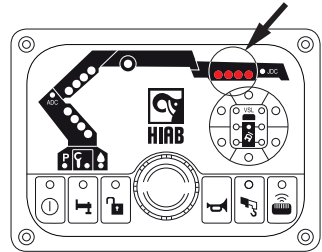

NOTE

Do not operate heavy loads with the extensions fully retracted. In the event of OLP it is an advantage to be able to retract the extensions.



DANGER

Never use the OLP override to overload the crane deliberately! Never exceed the values given on the load plate.



NOTE

In case of a crane breakdown, the use of OLP release will be part of the investigation. If the use of OLP release is to excessive it might affect warranty.

5.9. Manual extensions [option]

Operation with manual extensions

- Always extend the hydraulic extensions first, then the manual extensions.
- The use of manual extensions should be restricted to the longest outreach needed. When this reach is not needed, the manual extension should be retracted.



DANGER

Do not stand in front of moving parts. They may eventually move and cause injuries.



WARNING

Never use the SAF feature with the manual extensions extended.



CAUTION

To operate the crane to transport position, do not forget either dismantle manual extension or place manual extension completely into the last hydraulic extension.

5.9.1. Assembling and disassembling JIB manual extensions



DANGER

Do not stand in front of moving parts. They may move and cause injuries.

Assembling the manual extension

1. Place the manual extension (1) into the last JIB extension until it is possible to place the locking device (2) in holes (3) (working position) or (4) (transport position).
2. Attach the manual extension. Push the shaft (2) and slew 90° until is locked.
3. Install the security support (5).

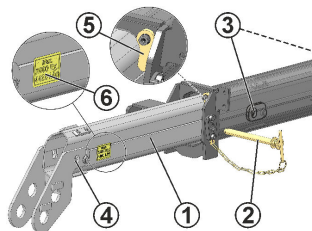

Disassembling the manual extension

1. Remove the security support (5).
2. Remove the locking device. Push the shaft (2) and slew 90° until is unlocked.
3. Remove carefully the manual extension (1) from the last JIB extension.



DANGER

Never exceed the value given on the manual extension load plate (6). Manual extension may break and cause injuries.

Activate and de-activate OLP for manual extensions on the User Interface



WARNING

You must switch the OLP on and off manually for additional manual extensions!

Activate:

Push button  on the User Interface.

The manual extensions are now included in the OLP protection. The lifting capacity will be reduced automatically. The lamp for  lights up on the User Interface.

De-activate:

Push the button again. The lamp for  goes out.



Activate and de-activate OLP for manual extensions on the XSDrive controller



WARNING

You must switch the OLP on and off manually for additional manual extensions!

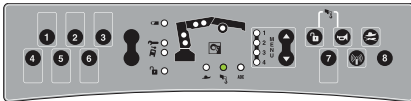

Activate:

Push buttons  and  on the controller.

The manual extensions are now included in the OLP protection. The lifting capacity will be reduced automatically. The lamp for  lights up on the User Interface.

De-activate:

Push the buttons again. The lamp for  goes out.



Activate and de-activate OLP for manual extensions on the CombiDrive controller



WARNING

You must switch the OLP on and off manually for additional manual extensions!

Activate:

Push both button (1) and (2) until symbol  on the centre display is lit.

(The lamp for manual extension is lit on the User Interface.)

The manual extensions are now included in the OLP protection. The lifting capacity will be reduced automatically.



De-activate:

Push the button (1) and (2) again. The symbol  on the centre display goes out.

(The lamp for manual extension goes out on the User Interface.)

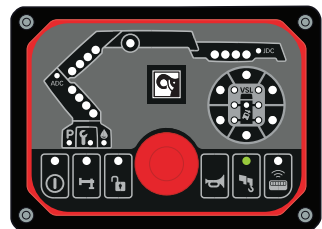
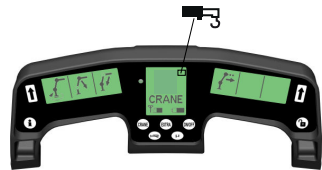

5.10. Raised hook support [option]

This support allows to raise the attachment point of the hook.



DANGER

Do not stand in front of moving parts. They may move and cause injuries.

Assembling the raised hook support

1. Place the raised hook support (1) into the last JIB extension until it is possible to place the locking device (2) in the hole.
2. Attach the raised hook support. Push the shaft (2) and slew 90° until is locked.
3. Make sure that the raised hook support is correctly locked by the locking shaft.

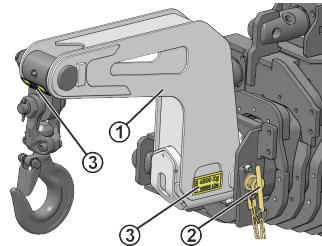

Disassembling the raised hook support

1. Remove the locking shaft (2).
2. Remove the locking device. Push the shaft (2) and slew 90° until is unlocked.
3. Remove carefully the raised hook support (1) from the last JIB extension.



DANGER

Never exceed the value given on the accessories load plates (3). They may break and cause injuries.



WARNING

- This support is **not compatible with the hoist**.
- To operate the crane in transport position, do not forget to disassemble the raised hook support.
- Never use the SAF feature with the raised hook support assembled.

5.11. Special hook application without disassembling the JIB

This is the special hook application to handle heavy loads without disassembling the JIB.

1. Raise the 1st boom (1).
2. Retract the JIB extensions (2).
3. Remove the hook from the tip of the JIB.
4. Operate the JIB against the 2nd boom (3).
5. Attach the hook support "A" to the JIB support for the ground "B".
6. Attach the hook "C" to the hook support "A" with the shaft and locking pin "D".
7. Attach the load to the hook "C".

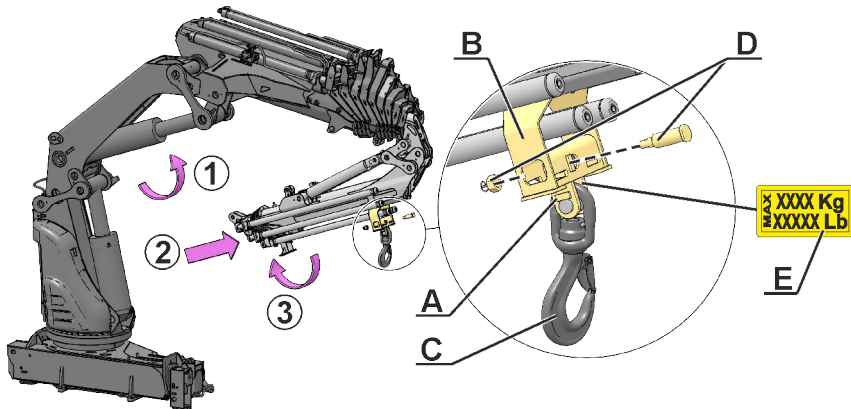

DANGER

Never exceed the value given on the accessories load plates "E". Accessories may break and cause injuries.



CAUTION

To operate the crane to transport position, do not forget to disassemble the hook support "A" and hook "C" from the JIB support for the ground "B".

6. Operation with hoist

6.1. Operation with hoist

If a hoist is mounted on the crane the rope is guided by pulleys mounted on the extensions and on the JIB.

6.2. Displacing the hoist

6.2.1. Displacing the hoist with the XSDrive

The hoist must work in its central position.



DANGER

Before lifting load with the hoist, be sure that the hoist is in working position.

Press the crane menu button (1) to go to crane menu 2.

To displace the hoist from the outside position to the central position (A):

1. Keep the 6th lever forward.
2. Move the hoist to the central position (working position) with the 5th lever forward.

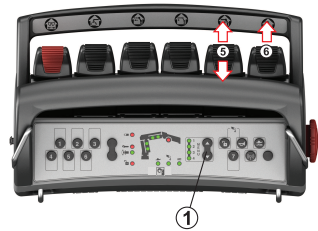

WARNING

To operate the crane to parking position when it has JIB and hoist, the hoist must be placed in the outside position.

To displace the hoist from the central position to the outside position (B):

1. Keep the 6th lever forward.
2. Move the hoist to the outside position (transport position) with the 5th lever backward.

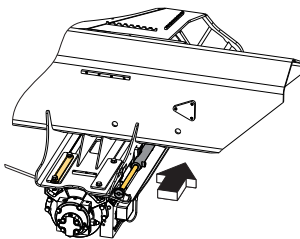

(A)

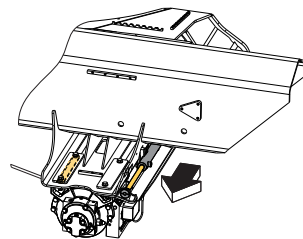

(B)

6.2.2. Displacing the hoist with the CombiDrive

The hoist must work in its central position.



DANGER

Before lifting load with the hoist, be sure that the hoist is in working position.

Press the crane menu button (1) to go to crane menu 2.

To displace the hoist from the outside position to the central position (A):

1. Keep the 8th lever forward.
2. Move the hoist to the central position (working position) with the 7th lever forward.

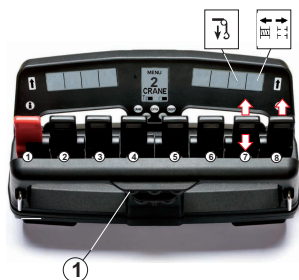

WARNING

To operate the crane to parking position when it has JIB and hoist, the hoist must be placed in the outside position.

To displace the hoist from the central position to the outside position (B):

1. Keep the 8th lever forward.
2. Move the hoist to the outside position (transport position) with the 7th lever backward.

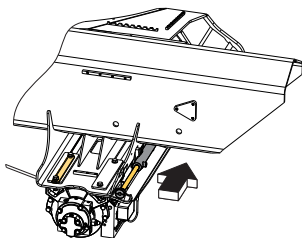

(A)

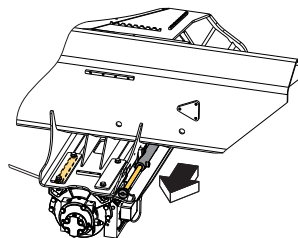

(B)

6.3. Connecting the hoist TI2L/TI4 rope to the JIB.155Q



WARNING

During the following operations, keep the rope loose. Use the controller to wind/unwind the rope while putting/removing the rope from the pulleys.

1. Make sure that the hoist is in the central position (working position).

2. Remove the rope from the support (1).

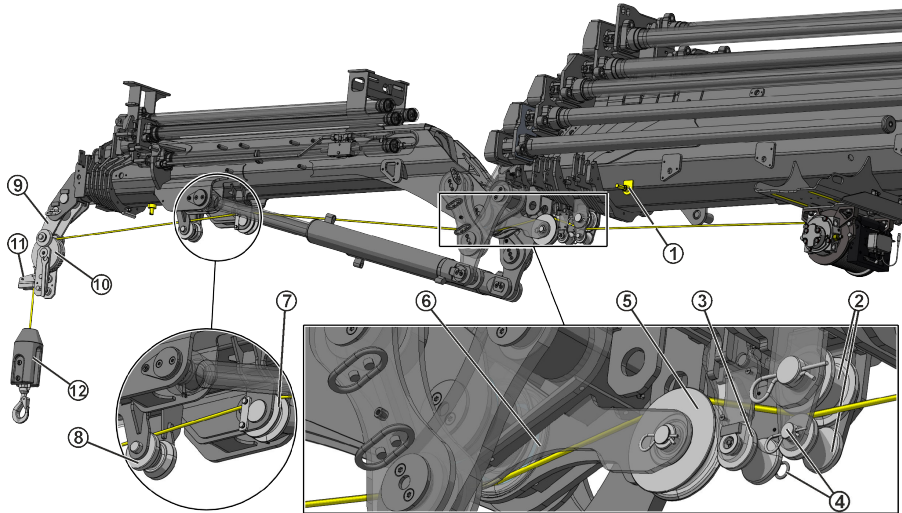

3. Put the rope through the pulleys (2) and (3):

NOTE

Pulley (3) is only for crane configurations with more than 8 boom extensions.

- a. Remove the securing pins and shafts (4) and pulleys (2) and (3).
 - b. Put the rope through the pulleys (2) and (3).
 - c. Install the securing pins and shafts (4) and pulleys (2) and (3) again.
4. Put the rope through the pulleys (5) and (6).

NOTE

Keep the crane extensions a little bit extended to remove the rope through the pulley (5) without disassembling it.

5. Put the rope through the pulleys (7) and (8).
6. Attach the top-roller support (9) on the last JIB extension.
7. Top-roller (10):
 - a. Attach the top-roller (10) to the top-roller support (9).
 - b. Remove the securing pin and shaft (11).
 - c. Put the rope through the top-roller (10).
 - d. Install the securing pin and shaft (11) again.
8. Attach the rope end to the counterweight and hook (12).

6.4. Disconnecting the hoist TI2L/TI4 rope from the JIB.155Q



WARNING

- During the following operations, keep the rope loose. Use the controller to wind/unwind the rope while putting/removing the rope from the pulleys.
- To obtain a correct winding, the rope has to be guided. A wrong winding can result in damage on rope or unexpected movements.

1. Make sure that the hoist is in the central position (working position).
2. Remove hook and counterweight (1).
3. Top-roller (2):
 - a. Remove the securing pin and shaft (3).
 - b. Remove the rope through the top-roller (2).
 - c. Install the securing pin and shaft (3) again.
 - d. Remove the top-roller (2).
 - e. Remove the top-roller support (4).

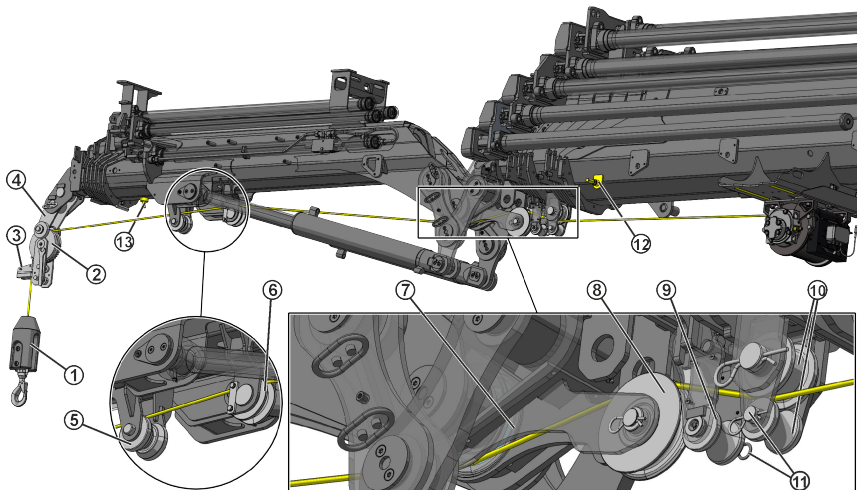

4. Remove the rope through the pulleys (5) and (6).
5. Remove the rope through the pulleys (7) and (8).



NOTE

Keep the crane extensions a little bit extended to remove the rope through the pulley (8) without disassembling it.

6. Remove the rope through the pulleys (9) and (10).

NOTE

Pulley (9) is only for crane configurations with more than 8 boom extensions.

- a. Remove the securing pins and shafts (11) and pulleys (9) and (10).
 - b. Remove the rope through the pulleys (9) and (10).
 - c. Install the securing pins and shafts (11) and pulleys (9) and (10) again.
7. Attach the rope end to the support (12) on the 2nd boom.

NOTE

Do not use the rope end support (13) on the JIB for this crane configuration.

6.5. Assembling the JIB.155Q with hoist TI2L/TI4

1. Follow the procedure: [Section 5.1: Assembling the JIB.155Q \(without hoist\) \(page 17\)](#).
2. Make sure that the hoist is in the central position (working position).

WARNING

To obtain a correct rolling up, the rope has to be guided. A wrong rolling up can result in damage on rope or unexpected movements.

3. Follow the procedure: [Section 6.3: Connecting the hoist TI2L/TI4 rope to the JIB.155Q \(page 39\)](#) for your crane configuration.

6.6. Disassembling the JIB.155Q with hoist TI2L/TI4

WARNING

- During the following operations, keep the rope loose. Use the controller to wind/unwind the rope while putting/removing the rope from the pulleys.
- To obtain a correct winding, the rope has to be guided. A wrong winding can result in damage on rope or unexpected movements.

1. Make sure that the hoist is in the central position (working position).
2. Follow the procedure: [Section 6.4: Disconnecting the hoist TI2L/TI4 rope from the JIB.155Q \(page 41\)](#) for your crane configuration.
3. Follow the procedure: [Section 5.2: Disassembling the JIB.155Q \(without hoist\) \(page 19\)](#).
4. Move the hoist to the outside position if you are going to operate the boom system into transport position. Tight the rope lightly.

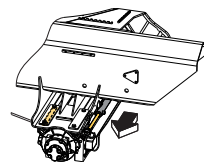

6.7. Operating a crane with JIB.155Q and hoist TI2L/TI4 out of parked position



WARNING

- Always ensure that the stabiliser extensions and legs are in working position and securely locked before operating the boom system out of parking position.
- During the following operations, keep the rope loose. Use the controller to wind/unwind the rope while putting/removing the rope from the pulleys.

EFFER iQ.950-1200 HP

1. Follow the procedure: [Section 5.4: Operate the crane with JIB \(without hoist\) out of parked position \(page 23\)](#) for your crane configuration.
2. Follow the procedure: [Section 6.3: Connecting the hoist TI2L/TI4 rope to the JIB.155Q \(page 39\)](#) for your crane configuration.
3. Make sure that the hoist is in the central position (working position).

6.8. Operating a crane with JIB.155Q and hoist TI2L/TI4 to parking position



WARNING

- During the following operations, keep the rope loose. Use the controller to wind/unwind the rope while putting/removing the rope from the pulleys.
- To obtain a correct winding, the rope has to be guided. A wrong winding can result in damage on rope or unexpected movements.

EFFER iQ.950-1200 HP

1. Follow the procedure: [Section 6.4: Disconnecting the hoist TI2L/TI4 rope from the JIB.155Q \(page 41\)](#) for your crane configuration.



WARNING

Displace the hoist to the central position before operating the crane to parking position with JIB and hoist.

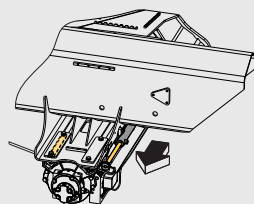

2. Follow the procedure: [Section 5.7: Operate the crane with a JIB \(without hoist\) to parking position \(page 30\)](#) for your crane configuration.

6.9. Operating with hoist TI2L/TI4 (without JIB.155Q)



NOTE

Intermediate pulley on the 6th extension exists only for crane configurations with more than 8 extensions.



CAUTION

- The intermediate pulleys on the crane (4th extension and 6th extension) are different when working with the JIB or with the crane.
- You must use the correct intermediate pulleys to work with the crane or with the JIB.
- The hoist must work in its central position.

Once the JIB has been disassembled:

1. Make sure that the hoist is in the central position (working position).
2. Remove the intermediate pulleys (1) assembled on the crane for the JIB operation.
3. Attach the intermediate pulleys (2) for the crane operation.

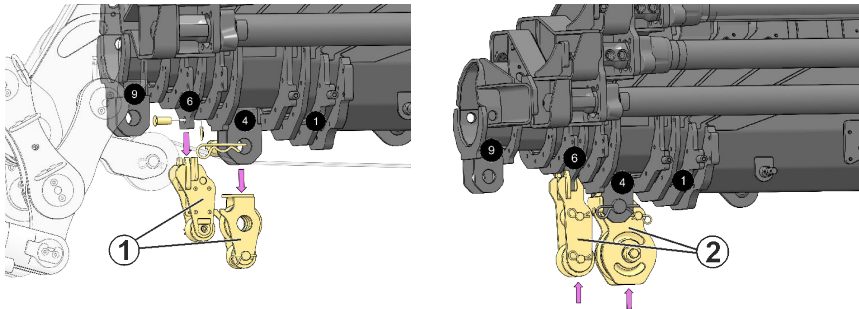

4. Attach the top-roller support for TI2L (3a) or TI4 (3b) on the last extension of the crane.

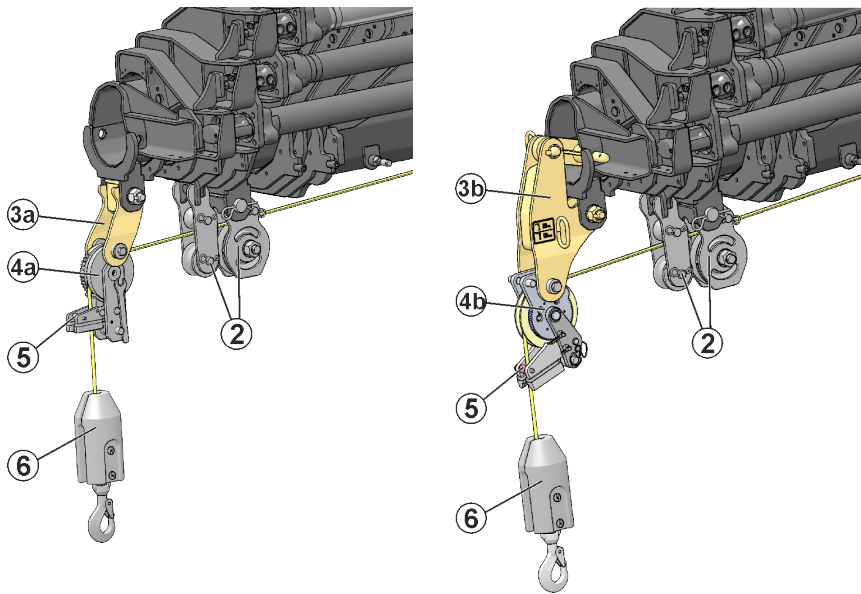

5. Put the rope through the intermediate pulleys (2).
6. Top-roller (4a) for the T12L or (4b) for the T14:
 - a. Attach the top-roller (4a) or (4b) to the top-roller support (3a) or (3b).
 - b. Remove the securing pin and shaft (5).
 - c. Put the rope through the top-roller (4a) or (4b).
 - d. Install the securing pin and shaft (5) again.
7. Attach the rope end to the counterweight and hook (6).

7. Maintenance

7.1. Maintenance and service

Follow the instructions in this manual and the Operator's Manual for your crane.

7.2. Lubrication

General greasing of the cranes

Incorrect or insufficient lubrication of a crane is the number one cause of premature failure.



WARNING

Before and after a long stop of the crane, lubrication is absolutely necessary. This is especially important after a winter shutdown.



WARNING

Follow the lubrication schedule exactly. If you do not do so, you can cause serious damage to the crane, interchangeable equipment and/or optional crane component.

Procedure:

1. Shut down the crane.
2. Make sure that all the lubrication points are clean before lubricating. Dirt can damage the parts.
3. Lubricate all points in each section.
4. Operate the crane through the full cycle for each section. Moving the lubricated parts is really important to get the full and correct lubrication of all moving components.
5. Shut down the crane and repeat the lubrication.
6. Lubrication is finished when the grease spills out from the ends. Clean the excess grease.



WARNING

Personnel should never attempt to work on a crane that is moving. Serious injury or death will occur if you try to work on an activated/moving crane.



CAUTION

When you use pressure grease pumps, open the plastic safety guard of the nipple and close it at the end.

Greases

Use lithium-based grease containing EP additives (consistencies 2 and 3 are recommended, depending on the climate).



CAUTION

Do NOT grease with graphite or molybdenum-disulphide additives.

Recommended greases:



BP LS EP 2, ESSO UNIWAY EP2 N, AGIP GR MU/EP3, NYNÄS UNIFETT EP.

Alternative:

Use a Teflon grease spray to lubricate the extensions and mobile parts.

7.3. Lubrication schedule

1. Extend the extensions totally.
2. Lubricate all marked points.

	Lubricate every 16 running hours.
	Grease every 16 running hours.

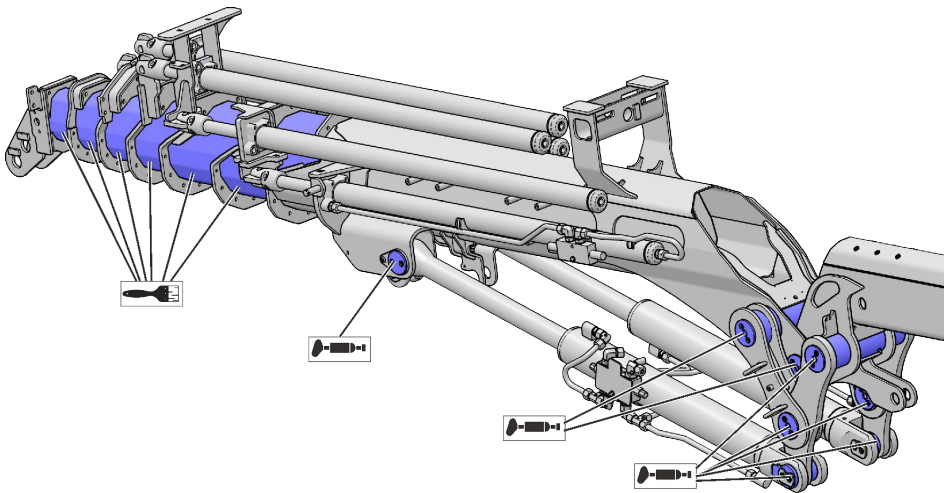

Lubrication of slide pads in the JIB extensions

Clean the surfaces and remove with a spatula all abrasive material (dirt, sand, shavings), and where possible, the old grease.



CAUTION

Use only grease 'STABYL TA' with the slide pads 'TECAGLIDE PA6 C' (green colour).



NOTE

To prevent or correct malfunctions or the “stick-slip” of the boom extensions operation, we recommend lubricating the lower part of the extensions.

If you have any doubt, please contact your Effer representative.

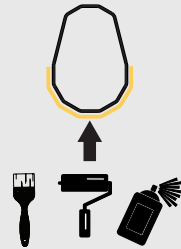

7.4. Faults

If faults occur with the JIB, contact an authorised service workshop.



NOTE

- when you use the JIB, connect the JIB connector (1) to the SPACE control system.
- after you remove the JIB: put the plug (2) in the SPACE connection for the JIB and crane.

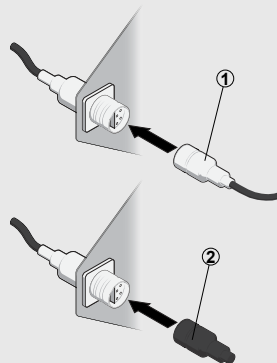

WARNING

Never try to repair the JIB yourself!

8. Technical Data

Documentation

The Technical Data for the JIB shall be printed out when installed on the crane.

The Operator's manuals for the crane and the JIB should be stored together with Technical Data for both.

© EFFER

All rights reserved.

No part of this publication may be reproduced or copied in any form or by any means without written permission from EFFER.

EFFER is part of Cargotec Corporation.

